



BASEPLATE KIT INSTALLATION INSTRUCTIONS

KIT# 1439-1

05/02/18
KS

ROADMASTER, Inc. 6110 NE 127th Ave. Vancouver, WA 98682 360-896-0407 fax 360-735-9300 www.roadmasterinc.com

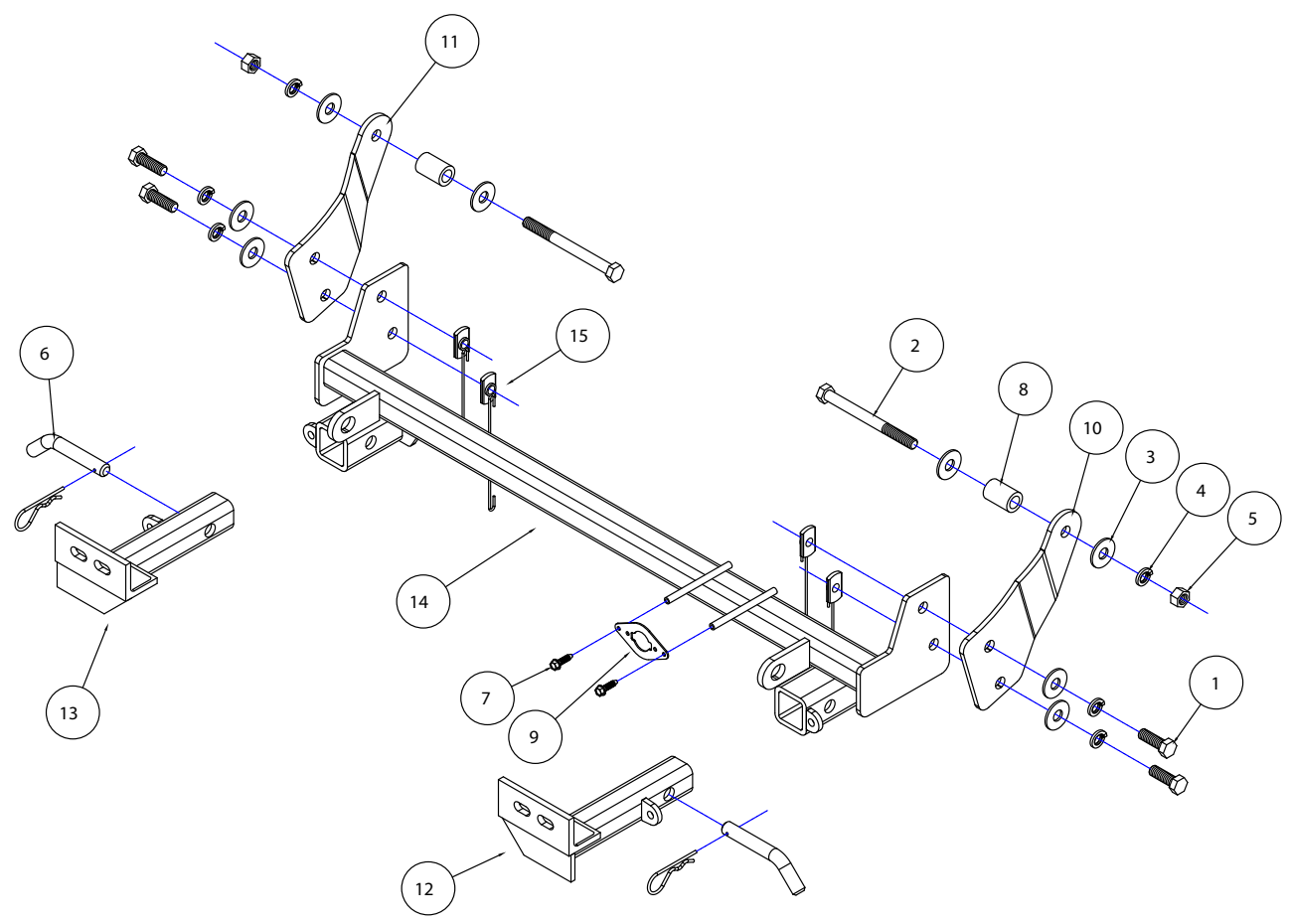

ITEM	QTY	NAME	PART #
1	4	1/2" x 2" BOLT	350096-00
2	2	1/2" x 5 1/2" BOLT	350108-00
3	8	1/2" FLAT WASHER	350308-00
4	6	1/2" LOCK WASHER	350309-00
5	2	1/2" HEX NUT	350258-00
6	2	5/8" DRAW PIN W/ CLIP	357035-00
7	2	#10 x 3/4" SELF TAPPING SCREW	350247-35
8	2	1" O.D. x 0.188 WALL TUBE x 1 1/2"	A-002898
9	1	WIRE PLUG PLATE	A-003801
10	1	DRIVER SIDE BRACE	B-002160
11	1	PASSENGER SIDE BRACE	B-002161
12	1	DRIVER SIDE ARM	C-002450
13	1	PASSENGER SIDE ARM	C-002451
14	1	MAIN RECEIVER	C-002452
15	4	1/2" TAB WELD NUT WITH 6" ROD	C-002870



BASEPLATE KIT INSTALLATION INSTRUCTIONS

KIT# 1439-1

05/02/18
KS

ROADMASTER, Inc. 6110 NE 127th Ave. Vancouver, WA 98682 360-896-0407 fax 360-735-9300 www.roadmasterinc.com

This is one of our XL series brackets, which allows the visible front portion of the bracket to be easily removed from the front of the vehicle (Fig.A and Fig.B). The bracket consists of a main receiver brace, two support braces, two removable front braces, and a hardware pack.

The main receiver brace mounts to the sub-frame; the support braces mount to the main receiver brace and frame rails.

Before starting the installation, lay out the kit components in order, as they will be used. This will give you a visual idea of how the components work, and will also confirm that everything is present and accounted for.



IMPORTANT: All baseplates **must** be assembled with all the bolts left loose for final adjustment and positioning (before tightening) unless otherwise instructed. All bolts **must** be torqued for proper strength. If more than one bolt is used per fastening point, the diagram may only show one. Use flat washers over all slotted holes and lock washers on all fasteners.

WARNING

Failure to heed these warnings or follow the installation instructions may result in a voided warranty, loss of towed vehicle, personal injury or death.

- Do not weld or modify this baseplate or its components. Welding or modification will void the warranty.
- Do not use this document as a basis to design/fabricate a baseplate, as it may not show all parts or structural components.
- We strongly recommend professional installation.
- If the towed vehicle has been in an accident, it must be properly repaired before attaching the baseplate. Do not install the baseplate if any structural frame damage is found.
- The installer must use all bolts and parts supplied. If running changes were made by the vehicle manufacturer after this kit was designed, some bolts or other fasteners may no longer be the correct size. It is the installer's responsibility to verify this kit is securely fastened to the vehicle.
- Use Loctite® Red on all bolts used to secure this baseplate. Torque all bolts to the specifications found at the end of these instructions. Do not over-torque the bolts or failure may occur.
- The installer must inspect the baseplate to ensure adequate clearance, particularly around hoses, air conditioner lines, radiators, etc. or non-warranty failure may result.
- Roadmaster manufactures many styles of baseplates. If your baseplate has removable arms, they must be removed before driving the vehicle, unless the arms can be pinned or padlocked in place. If not secured, the arms could vibrate out.
- Some motorhome chassis have such a tight turning radius that you can damage your motorhome, towed vehicle, tow bar or baseplate while turning sharply. Before getting on the road, test your turning radius in an empty parking lot. Turning too sharply could result in non-warranty damage to your towing system, motorhome and/or towed vehicle.
- Do not back up with the towed vehicle attached or non-warranty damage will occur to your towing system or vehicles.
- The safety cables must connect the towing vehicle to the towed vehicle frame to frame, with the cables crossed, with enough slack for sharp turns. See cable instructions for proper routing. Failure to do so will result in non-warranty damage and/or the loss of the towed vehicle.
- This kit is designed for use with ROADMASTER tow bars and ROADMASTER adapters only. Using this kit with other brands, without an approved ROADMASTER adapter, may result in non-warranty damage or injury.
- Receiver extensions and out-of-level towing situations of 3 inches or more. This can cause the system to swing much higher and lower, causing excessive strain on the tow bar, baseplate and frame. That can cause the towing system to fail, causing property damage, personal injury or even death. If you must use a receiver extension or drop hitch to tow, it will reduce your receiver's weight capacity by 1/3 to avoid damaging your system. Never use more than one extension and/or drop hitch, as this will void your warranty.
- Every 3,000 miles, the owner must inspect all mounting points for cracks or fatigue, and check the fasteners for proper torque, according to the bolt torque requirements chart on the last page of these instructions.
- The owner must follow the vehicle manufacturer's instructions to prepare the vehicle for towing. Failure to do so may cause severe damage to the vehicle.
- This baseplate is only warranted for the original installation. Installing a used baseplate on another vehicle is not recommended and will void the warranty.



BASEPLATE KIT INSTALLATION INSTRUCTIONS

KIT# 1439-1

05/02/18
KS

ROADMASTER, Inc. 6110 NE 127th Ave. Vancouver, WA 98682 360-896-0407 fax 360-735-9300 www.roadmasterinc.com

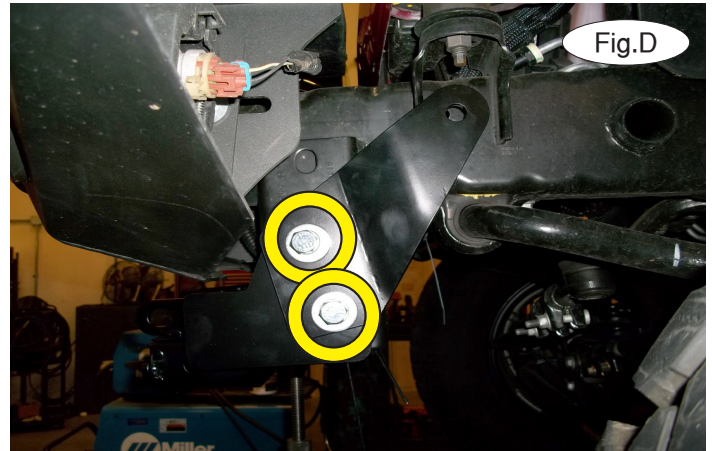
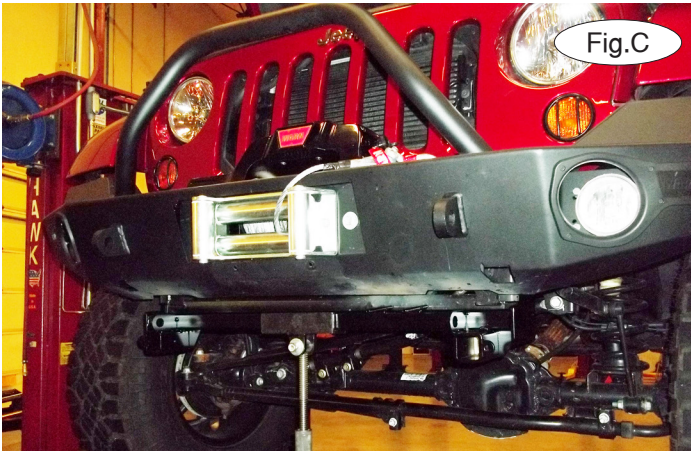

1. **Important:** please use all supplied bolts and parts and read all instructions carefully before beginning this installation. The majority of questions you may have can be answered within the text, and proper installation will ensure safe and secure travel. Now, begin the installation. **For Call of Duty MW3 and Moab models only:** proceed to the supplement at the end of these instructions to remove the skid plate and bracketing first. **For all other models:** fit the main receiver brace around the lower subframe, aligning the lower holes with the pre-existing holes in the subframe. Use a support stand, if necessary (Fig.C).

2. On each side, place one of the supplied $\frac{1}{2}$ " lock washers and one of the $\frac{1}{2}$ " washers over one of the supplied $\frac{1}{2}$ " x $1\frac{3}{4}$ " bolts. Now, align the lowermost holes of the support brace with the holes in the main receiver brace, ensuring the bend of the brace is offset away from the frame, then bolt through the support brace, main receiver brace, subframe and into one of the $\frac{3}{16}$ " x 1" x 1" threading backing plates with wire. Repeat this process for the remaining hole (Fig.D). *Note:* ensure proper alignment, as the bolts will receive Loctite® Red and will be torqued at the end of these instructions.

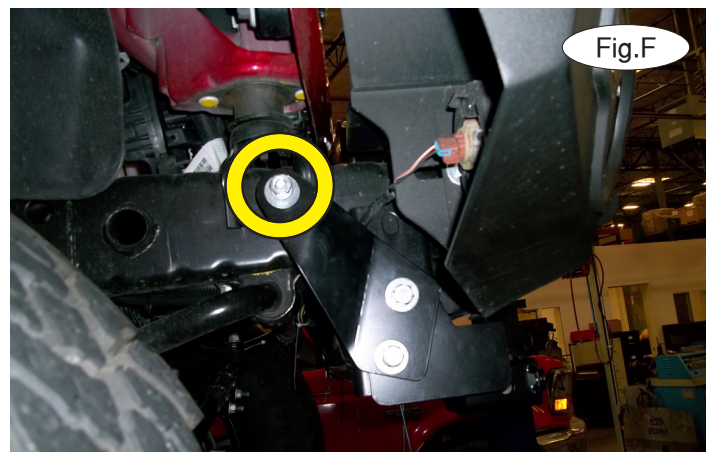
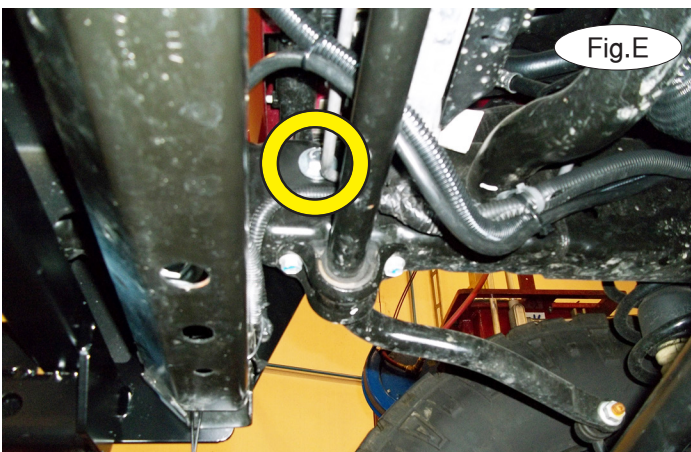

3. On each side, place one of the supplied 1" x $1\frac{1}{2}$ " x .188 wall pipe spacers between the support bracket and the frame rail, aligning it with the holes in the support bracket and the frame rail. Place one of the supplied $\frac{1}{2}$ " washers over a $\frac{1}{2}$ " x $5\frac{1}{2}$ " bolt. *Note:* due to manufacturing variances, the hole in the outside of the frame rail may not exist. If this is the case, use a $\frac{1}{2}$ " drill bit and the hole in the support bracket as a template to drill out a hole.

Now, reach in behind the bumper and bolt toward the outside of the vehicle through the pre-existing hole on the inside of the frame, through the pipe spacer, and through the uppermost hole of the support brace. Finish with a $\frac{1}{2}$ " flat washer, lock washer and nut (Fig.E and Fig.F). **For Call of Duty MW3 and Moab models only:** place the bumper bracket you removed in step 2 of the supplemental instructions over the top of the support bracket before bolting.

4. Tighten all bolts to the bolt torque requirements found at the end of these instructions. *Note:* use Loctite® Red on all nuts and bolts.



BASEPLATE KIT INSTALLATION INSTRUCTIONS

KIT# 1439-1

05/02/18
KS

ROADMASTER, Inc. 6110 NE 127th Ave. Vancouver, WA 98682 360-896-0407 fax 360-735-9300 www.roadmasterinc.com

5. Use a pair of pliers to break the wires off the backing plates.
6. Insert the removable front bracket arms into the front receiver braces.
7. Install the tow bar to the mounting bracket according to the manufacturer's instructions.

IMPORTANT!

Safety cables are required by law. When towing, connect safety cables to the safety cable tabs illustrated on page 1. Make certain there is adequate slack in the cables to allow a full turning radius; otherwise, damage will result. If necessary, longer cables or cable extensions are available.

Note: if the bracket is so equipped, the holes in the alignment tabs which are welded to the arms and main receiver braces are for padlocks only. Under no circumstances should you bolt the alignment tabs together. Bolting the alignment tabs together may result in non-warranty damage to the bracket.

Three options for attaching the wiring plug to the main receiver brace

For six-wire plugs: use the two supplied 3/4" self-tapping screws to attach the electrical plug directly to the rods on the front of the main receiver brace.

For four-wire round plugs: attach to the plug mounting plate and then use the two supplied 3/4" self-tapping screws to attach the mounting plate to the rods on the front of the main receiver brace.

For four-wire flat plugs: place the plug through the mounting plug plate, and then secure it using the supplied zip tie on the front of the plug (Fig.G). Use the two supplied 3/4" self-tapping screws to attach the mounting plate to the rods on the front of the main receiver brace.

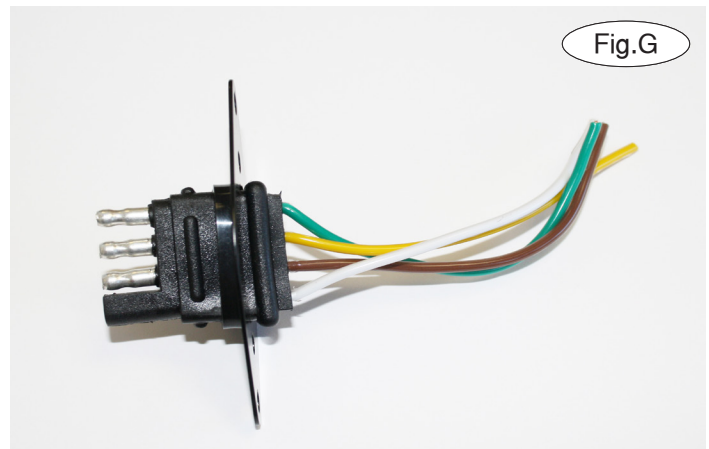

Fig.G

BOLT TORQUE REQUIREMENTS

Note: The torque values represented below are intended as general guidelines. Torque requirements for specific applications may vary. Roadmaster does not warrant this information to be accurate for all applications and disclaims all liability for any claims or damages which may result from its use.

STANDARD BOLTS

Thread Size	Grade	Torque
5/16	5	13 ft./lb.
3/8	5	23 ft./lb.
7/16	5	37 ft./lb.
1/2	5	56 ft./lb.
5/8	5	150 ft./lb.

METRIC BOLTS

Thread Size	Grade	Plated / Unplated
8mm-1.0	8.8	20 ft./lb. 18 ft./lb.
8mm-1.25	8.8	19 ft./lb. 18 ft./lb.
10mm-1.25	8.8	38 ft./lb. 36 ft./lb.
10mm-1.5	8.8	37 ft./lb. 35 ft./lb.

METRIC BOLTS

Thread Size	Grade	Plated / Unplated
12mm-1.25	8.8	70 ft./lb. 65 ft./lb.
12mm-1.5	8.8	66 ft./lb. 61 ft./lb.
12mm-1.75	8.8	65 ft./lb. 60 ft./lb.
14mm-2.0	8.8	104 ft./lb. 97 ft./lb.

All illustrations and specifications contained herein are based on the latest information available at the time of publication approval. ROADMASTER, INC. reserves the right to make changes at any time without notice in material, specification and models or to discontinue models.



BASEPLATE KIT INSTALLATION INSTRUCTIONS

KIT# 1439-1

05/02/18
KS

ROADMASTER, Inc. 6110 NE 127th Ave. Vancouver, WA 98682 360-896-0407 fax 360-735-9300 www.roadmasterinc.com

Supplemental Instructions for Call of Duty MW3 and Moab Models

This supplement provides instructions on removing the skid plate and bumper.

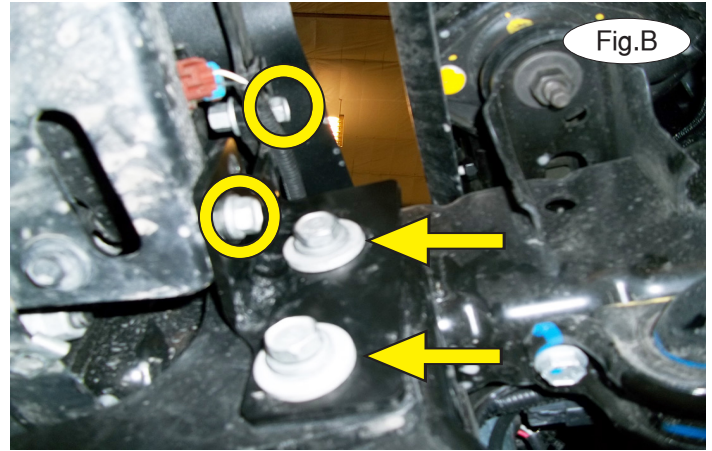
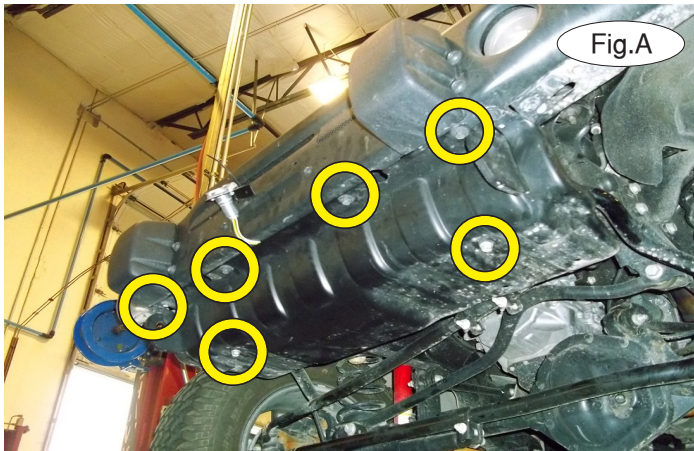

1. Remove four 13mm (head) bolts and two 15mm (head) nuts and bolts attaching the skid plate to the bumper (Fig.A). The skid plate will not be replaced. Retain the skid plate and attachment hardware for replacement in case the bracket is ever removed.

2. On each side, loosen two 10mm (head) nuts and bolts, and two 15mm (head) bolts and threaded backing plate attaching the bumper bracket to the bumper (Fig.B).

3. On each side, remove an 18mm (head) nut and bolt attaching the tow hook to the frame (Fig.C). *Note:* due to a lack of space, this can be quite difficult. Use the box end of a wrench to catch some of the corners of the nut to aid in its removal. The tow hook will not be replaced. Retain the tow hook and attachment hardware for replacement in case the bracket is ever removed.

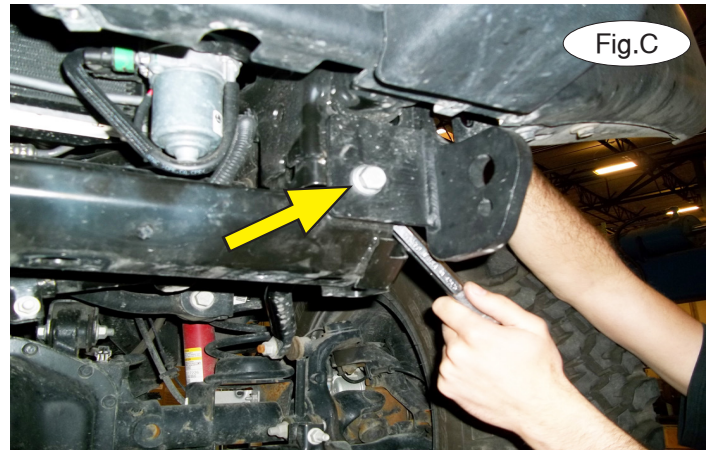

4. Fit the main receiver brace around the lower subframe, aligning the lower holes with the pre-existing holes in the subframe. Use a support stand, if necessary.

Now, return to step 2 in the regular instructions to finish the installation.