



MOUNTING BRACKET KIT INSTALLATION INSTRUCTIONS

KIT# 3144-3

04/25/08
KS

ROADMASTER, Inc. 6110 NE 127th Ave. Vancouver, WA 98682 1-800-669-9690 fax 360-735-9300 www.roadmasterinc.com

Important
Note: this bracket will not accommodate the Guardian rock shield, Tow Defender, Stowaway or the StowMaster and StowMaster All Terrain tow bars.

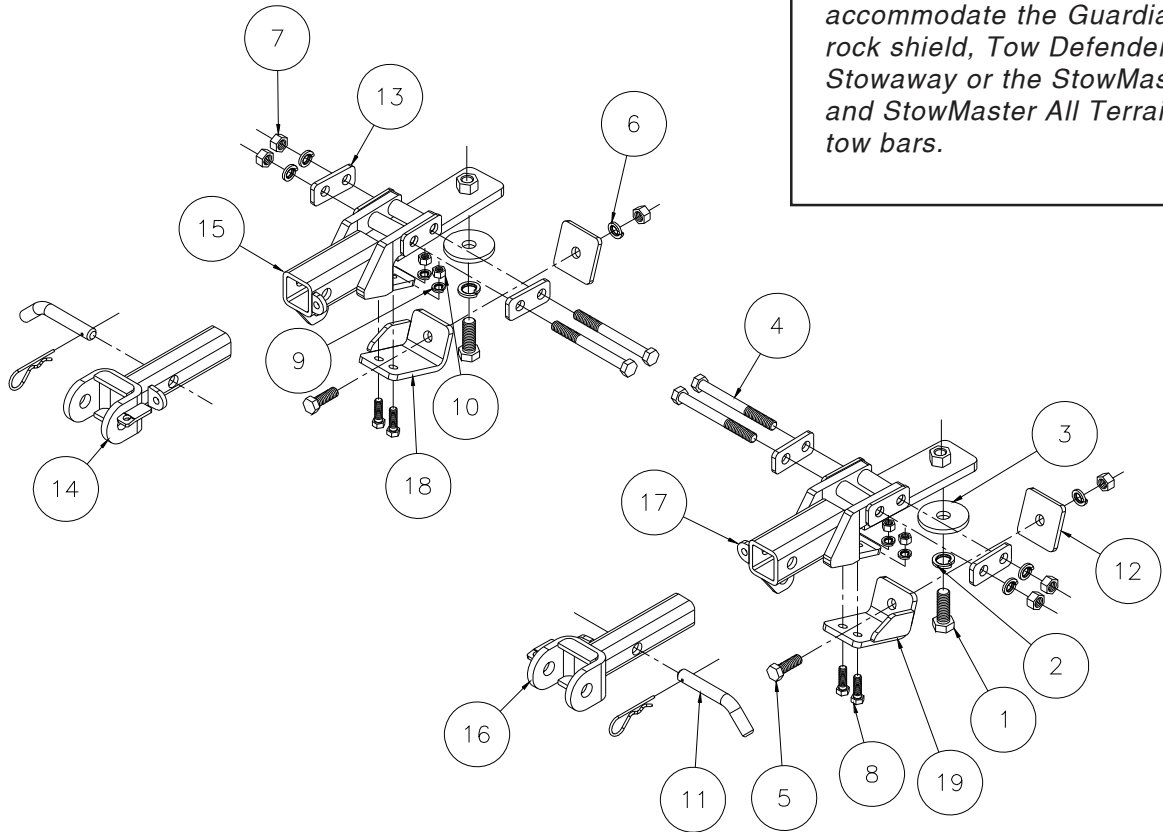

ITEM	QTY	NAME	MATERIAL
1	2	5/8" X 2" BOLT	350368-00
2	2	5/8" LOCK WASHER	350313-00
3	2	5/8" PLATE WASHER	350352-00
4	4	1/2" X 5" BOLT	350107-00
5	2	1/2" X 1 1/2" BOLT	350095-00
6	6	1/2" LOCK WASHER	350309-00
7	6	1/2" NUT	350258-00
8	4	3/8" X 1 1/4" BOLT	350056-00
9	4	3/8" LOCK WASHER	350305-00
10	4	3/8" NUT	350254-00
11	2	DRAW PINS, SPRING PINS	357035-00
12	2	1/4" X 2 1/2" FLAT BAR	100009-00
13	4	1/4" X 1 1/4" FLAT BAR	100004-00
14	1	PASSENGER SIDE ARM	C-001388
15	1	PASSENGER SIDE RECEIVER BRACE	C-001382
16	1	DRIVER SIDE ARM	C-001387
17	1	DRIVER SIDE RECEIVER BRACE	C-001381
18	1	PASSENGER SIDE LOWER BRACKET	C-001386
19	1	DRIVER SIDE LOWER BRACKET	C-001385



MOUNTING BRACKET KIT INSTALLATION INSTRUCTIONS

KIT# 3144-3

04/25/08
KS

ROADMASTER, Inc. 6110 NE 127th Ave. Vancouver, WA 98682 1-800-669-9690 fax 360-735-9300 www.roadmasterinc.com

This is one of our MX series brackets, which allows the visible front portion of the bracket to be easily removed from the front of the vehicle (Fig.A and Fig.B). The bracket consists of two main receiver braces, two lower braces, two removable front braces and a hardware pack.

The main receiver braces mount to the frame rails. The lower braces mount to the main braces and the frame. The removable front braces install in the main receiver braces.

Before starting the installation, lay out the kit components in order, as they will be used. This will give you a visual idea of how the components work, and will also confirm that everything is present and accounted for.



IMPORTANT: All brackets **must** be assembled with all the bolts left loose for final adjustment and positioning (before tightening) unless otherwise instructed. All bolts **must** be torqued for proper strength. If more than one bolt is used per fastening point, the diagram may only show one.

- Use flat washers over all slotted holes
- Use lock washers on all fasteners

ROADMASTER Limited Warranty, including One-Year Conditional Warranty Text and Product Registration Card, in Carton.

WARNING

- Do not use this document for custom fabrication, as it may not show all parts or structural components. Custom fabrication or an attempt to copy this bracket design could result in loss of the towed vehicle.
- The owner must inspect all mounts and brackets before each use for cracks or other signs of fatigue. Also, inspect the fasteners for proper torque, according to the bolt torque requirements chart on the last page. Failure to do so could result in loss of the towed vehicle.
- The owner must check the manufacturer's instructions for the proper procedure(s) to prepare the vehicle for towing. Some vehicles must be equipped with a transmission lube pump, an axle disconnect, driveline disconnect or free-wheeling hubs before they can be towed. Failure to properly equip the vehicle will cause severe damage to the transmission.
- The installer must read the instructions and use all bolts and parts supplied. Failure to securely fasten the bracket could result in loss of the towed vehicle.
- If running changes were made by the vehicle manufacturer after this bracket was designed, some bolts or other fasteners in the included hardware pack may no longer be the correct size. It is the installer's responsibility to verify that the bracket is securely fastened to the vehicle, and fitted with the correct hardware, to account for these changes. Failure to securely fasten the bracket could result in loss of the towed vehicle.
- If the towed vehicle has been in an accident, it must be properly repaired before attaching the bracket. Do not install the bracket if any structural frame damage is found. Failure to repair the damage may result in the loss of the towed vehicle.
- Some motorhome chassis have such a tight turning radius that you can damage your motorhome, towed vehicle, tow bar or bracket while turning sharply. Before getting on the road, test your turning radius in an empty parking lot. Turning too sharply could result in non-warranty damage to towing system, motorhome and/or towed vehicle.
- Do not back up with the towed vehicle attached or non-warranty damage will occur to your towing system, motorhome and/or towed vehicle.
- The safety cables must connect the towing vehicle to the towed vehicle frame to frame, with the cables crossed, with enough slack for sharp turns. Refer to the cable instructions for proper routing. Failure to leave enough slack in the safety cables, or failure to connect the safety cables frame to frame, will result in the loss of the towed vehicle.
- This bracket is designed for use with ROADMASTER tow bars and ROADMASTER adaptors only. Using this bracket with other brands, without an approved ROADMASTER adaptor, may result in non-warranty damage or injury.
- Upon final installation, the installer must inspect the bracket to ensure adequate clearance, particularly around hoses, air conditioner lines, radiators, etc., or non-warranty damage to the towed vehicle will result.
- This bracket is only warranted for the original installation. Installing a used bracket on another vehicle is not recommended and will void the warranty.

WARNING

Failure to follow these instructions can result in property damage, personal injury or even death.



MOUNTING BRACKET KIT INSTALLATION INSTRUCTIONS

KIT# 3144-3

04/25/08
KS

ROADMASTER, Inc. 6110 NE 127th Ave. Vancouver, WA 98682 1-800-669-9690 fax 360-735-9300 www.roadmasterinc.com

Tahoe, Yukon, Suburban and Avalanche Instructions

This bracket kit fits the Tahoe, Yukon, Suburban, Avalanche, Silverado and the Sierra. Follow the instructions below for the Tahoe, Yukon, Suburban and Avalanche; for the 2007 Silverado and Sierra, see the supplemental section included at the end of these instructions.

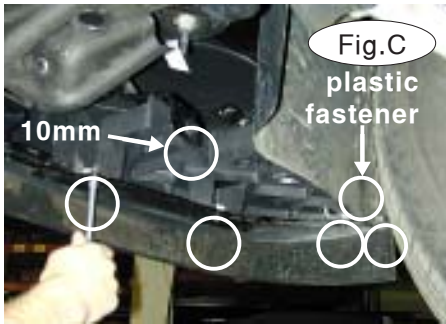

1. This bracket kit has two main receiver braces, one for the passenger side and one for the driver's side. First, install the passenger side brace.

Start by removing the lower fascia reinforcement on the passenger side – remove four 7mm (head) screws, one 10mm (head) screw, and one plastic fastener (Fig.C) to remove the fascia reinforcement (Fig.D).

2. Then, remove the tow hook – remove one 18mm (head) bolt, and one 18mm bolt and nut (Fig.E).

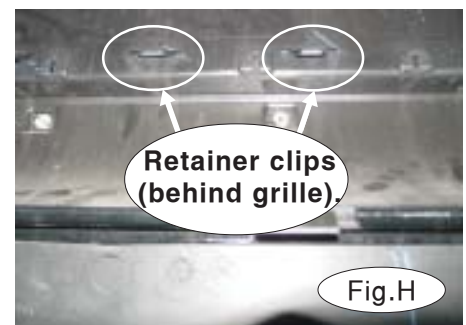
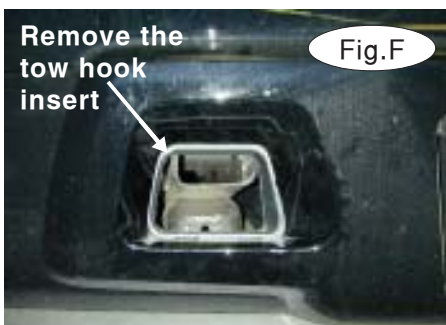

3. Remove the tow hook inserts (one on each side – Fig.F). Note: on 2007 GMC Yukon models the grille insert is one piece (Fig.G). Remove the insert by removing four plastic fasteners (two each side), and releasing nine plastic retainer clips. The four plastic fasteners are located above and below the tow hooks on each side. The plastic retainer clips are located in the center behind the grille (Fig.H).

4. Insert the passenger side main brace into the tow hook opening, and onto the front of the frame rail (Fig.I).

5. Attach the passenger side main brace to the bottom of the frame rail – thread one of the supplied 5/8" x 2" bolts, lock washers and plate washers through the existing hole at the bottom of the frame and into the existing weld nut at the bottom of the passenger side main brace (Fig.J).





MOUNTING BRACKET KIT INSTALLATION INSTRUCTIONS

KIT# 3144-3

04/25/08
KS

ROADMASTER, Inc. 6110 NE 127th Ave. Vancouver, WA 98682 1-800-669-9690 fax 360-735-9300 www.roadmasterinc.com



Fig.K



Fig.L

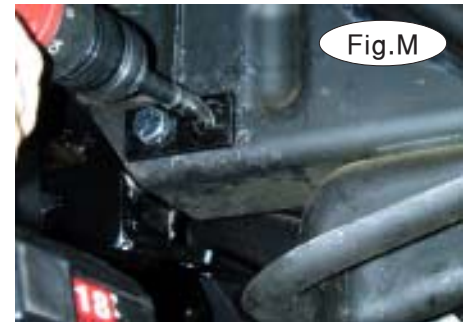

Fig.M

6. On the interior side, insert one of the supplied $\frac{1}{2}$ " x 5" bolts through one of the $\frac{1}{4}$ " x $1\frac{1}{4}$ " x $2\frac{3}{4}$ " backing plates (with two $\frac{9}{16}$ " holes) and into the existing hole at the front of the passenger side frame rail, which was used to attach the tow hook (Fig.K). (Note: due to manufacturing variances, this hole may need to be enlarged).

7. Now, level the backing plate to the bottom of the frame rail (Fig.L).

8. Using the other hole in the backing plate as a template, drill a $\frac{17}{32}$ " hole through the interior side of the frame rail and through the other side of the frame rail (Fig.M).



Fig.N



Fig.O



Fig.P

9. From the inside of the frame rail, insert another $\frac{1}{2}$ " x 5" bolt through the backing plate and the hole you just drilled. On the outside of the frame rail, position another $\frac{1}{4}$ " x $1\frac{1}{4}$ " x $2\frac{3}{4}$ " backing plate (with two $\frac{9}{16}$ " holes) over the bolts. Then, attach the backing plate with two $\frac{1}{2}$ " lock washers and nuts (Fig.N)

10. Bolt the lower brace to the main brace. Use two $\frac{3}{8}$ " x $1\frac{1}{4}$ " bolts, lock washers and nuts (Fig.O).

11. Hold one of the supplied $\frac{1}{4}$ " x $2\frac{1}{2}$ " x $2\frac{1}{2}$ " backing plates (with a $\frac{9}{16}$ " hole) over the back of the lower frame reinforcement (Fig.P). Next, using the hole in the backing plate as a template, drill a $\frac{17}{32}$ " hole through the lower frame reinforcement, and into the lower brace. Note: the hole is 2" from the bottom edge of the lower frame reinforcement, and centered.

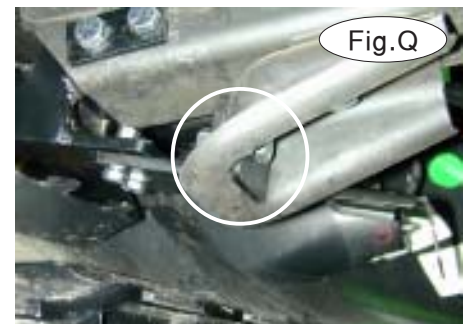

Fig.Q

12. Now, bolt through the backing plate, the hole you just drilled, the lower frame reinforcement, and the lower brace, using a $\frac{1}{2}$ " x $1\frac{1}{2}$ " bolt. Attach the bolt with a $\frac{1}{2}$ " lock washer and nut (Fig.Q).

13. This completes the installation of the passenger side brace. Now, install the driver's side brace. The driver's side brace is installed in the same manner, with two exceptions:

A. Do not remove the lower fascia reinforcement on the driver's side. B. On the driver's side, use the existing rear tow hook hole as a template to drill through the outer side of the frame rail (Fig.R).



Fig.R



MOUNTING BRACKET KIT INSTALLATION INSTRUCTIONS

KIT# 3144-3

04/25/08
KS

ROADMASTER, Inc. 6110 NE 127th Ave. Vancouver, WA 98682 1-800-669-9690 fax 360-735-9300 www.roadmasterinc.com



Fig.S



Fig.T

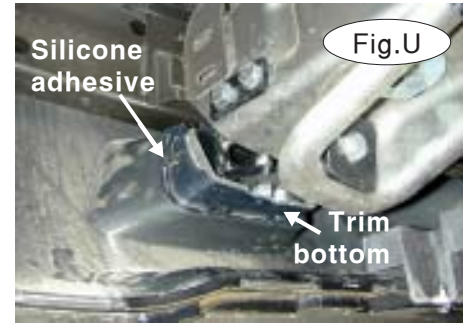

Fig.U

14. After installing the driver's side main brace, tighten all bolts on both braces to the torque specifications at the bottom of these instructions.
15. On both sides, trim the top and the bottom of the rubber tow hook inserts. Use the yellow marker line in Figure S as a reference. Note: for 2007 GMC Yukon refer to Figure T for correct trimming. Repeat trimming for the other side.
16. Test fit the rubber tow hook inserts, then trim the bottom of each insert to accommodate the heads of the 3/8" x 1 1/4" bolts attaching the lower brace to the main brace (Fig.U).
17. Reattach the rubber tow hook inserts, using a silicone adhesive along the side alignment tabs (Fig.U).
18. Reattach the passenger side lower fascia reinforcement, which you removed in step 1.
19. Fit the front bracket arms into the front receiver braces, and secure them in place with the supplied 5/8" draw pins and spring pins (Fig.V)
20. Install the tow bar to the mounting bracket according to the manufacturer's instructions. Attach the safety cables to the main receiver brace.



Fig.V

BOLT TORQUE REQUIREMENTS

Note: The torque values represented below are intended as general guidelines. Torque requirements for specific applications may vary. Roadmaster does not warrant this information to be accurate for all applications and disclaims all liability for any claims or damages which may result from its use.

STANDARD BOLTS

Thread Size	Grade	Torque
5/16	5	13 ft./lb.
3/8	5	23 ft./lb.
7/16	5	37 ft./lb.
1/2	5	56 ft./lb.
5/8	5	150 ft./lb.

METRIC BOLTS

Thread Size	Grade	Plated / Unplated
8mm-1.0	8.8	20 ft./lb. 18 ft./lb.
8mm-1.25	8.8	19 ft./lb. 18 ft./lb.
10mm-1.25	8.8	38 ft./lb. 36 ft./lb.
10mm-1.5	8.8	37 ft./lb. 35 ft./lb.

METRIC BOLTS

Thread Size	Grade	Plated / Unplated
12mm-1.25	8.8	70 ft./lb. 65 ft./lb.
12mm-1.5	8.8	66 ft./lb. 61 ft./lb.
12mm-1.75	8.8	65 ft./lb. 60 ft./lb.
14mm-2.0	8.8	104 ft./lb. 97 ft./lb.

All illustrations and specifications contained herein are based on the latest information available at the time of publication approval. ROADMASTER, INC. reserves the right to make changes at any time without notice in material, specification and models or to discontinue models.



MOUNTING BRACKET KIT INSTALLATION INSTRUCTIONS

KIT# 3144-3

04/25/08
KS

ROADMASTER, Inc. 6110 NE 127th Ave. Vancouver, WA 98682 1-800-669-9690 fax 360-735-9300 www.roadmasterinc.com

Supplemental Instructions – 2007 Silverado or Sierra

This supplement supersedes steps 1 through 3 in the mounting bracket installation instructions.



Fig.A



Fig.B



Fig.C

1. Remove eight plastic fasteners attaching the radiator cover to the grille and core support (Fig.A). Then remove the radiator cover.

2. There are two 21mm (head) bolts, one per side, attaching the bumper to the top of the frame rails. The bolts are located between the back of the grille and the radiator. Remove the bolts temporarily to install the bracket (Fig.B).

3. Remove the tow hooks – remove one 18mm (head) bolt, and one 18mm bolt and nut (Fig.C).

4. The tow hook openings in the front of the fascia need to be trimmed to allow access for the main receiver brace. See Figure D and E for correct trimming.

5. Now, proceed to step 4 in the mounting bracket installation instructions. *Note:* after the installation is complete, replace the bumper mounting bolts and radiator cover by reversing steps 1 and 2. Then, tighten the bumper mounting bolts to the torque specifications listed at the end of the mounting bracket installation instructions.

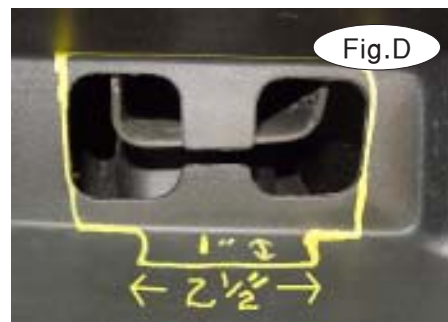

Fig.D



Fig.E