



# BASEPLATE KIT INSTALLATION INSTRUCTIONS

**KIT# 497-3**

04/08/04

ROADMASTER, Inc. 6110 NE 127th Ave. Vancouver, WA 98682 360-896-0407 fax 360-735-9300 www.roadmasterinc.com

**Important**

Note: this bracket will not accommodate the Guardian rock shield, some models of the Tow Defender, Stowaway or the StowMaster and StowMaster All Terrain tow bars.

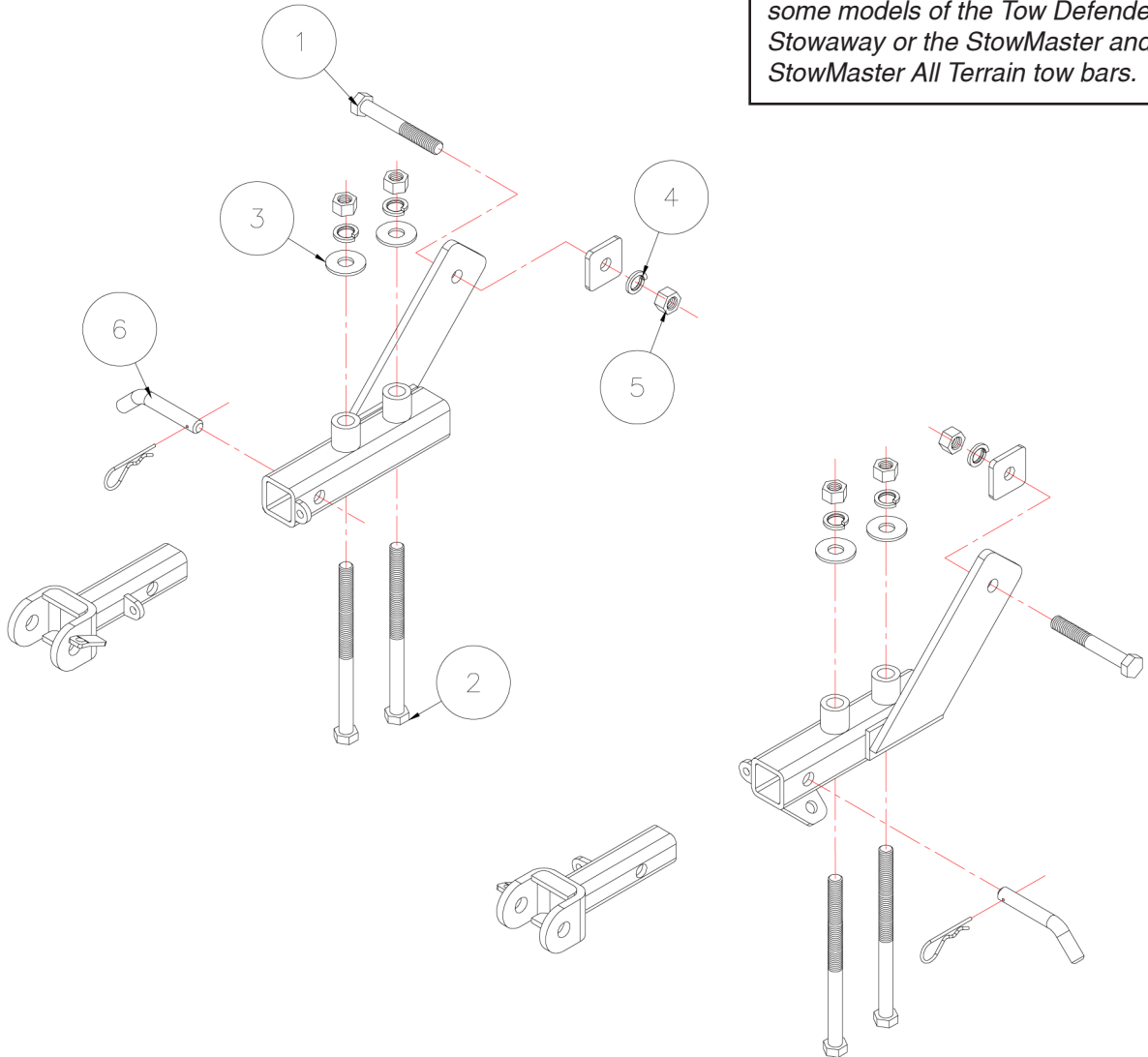

Item	Qty	Length	Width	Hardware	Part No.
1.....2.....4"			5/8"	BOLT.....	350158-00
2.....4.....9"			5/8"	BOLT.....	350379-00
3.....4.....			5/8"	FLAT WASHER.....	350348-00
4.....6.....			5/8"	LOCK WASHER.....	350313-00
5.....6.....			5/8"	NUT.....	350262-00
6.....2.....				DRAW PIN/SPRING PIN.....	357035-00

ROADMASTER, INC.



# BASEPLATE KIT INSTALLATION INSTRUCTIONS

**KIT# 497-3**

04/08/04

ROADMASTER, Inc. 6110 NE 127th Ave. Vancouver, WA 98682 360-896-0407 fax 360-735-9300 www.roadmasterinc.com

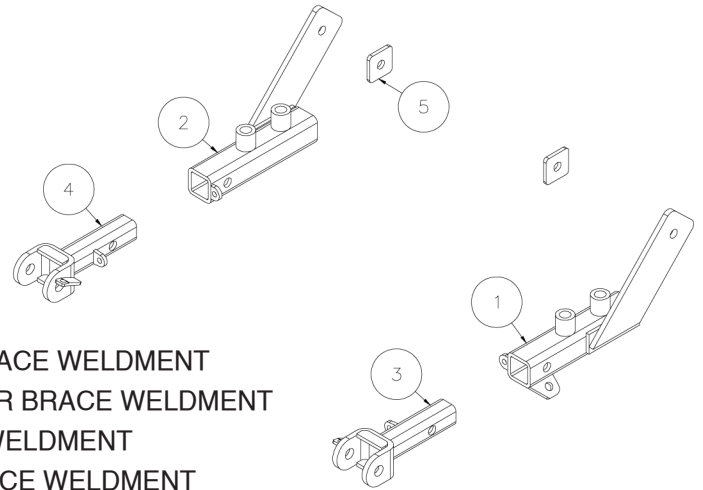

ITEM	QTY	PART NO.	ASSEMBLY
1.....	1	C-000871.....	DRIVER SIDE RECEIVER BRACE WELDMENT
2.....	1	C-000872.....	PASSENGER SIDE RECEIVER BRACE WELDMENT
3.....	1	C-000875.....	DRIVER SIDE ARM BRACE WELDMENT
4.....	1	C-000876.....	PASSENGER SIDE ARM BRACE WELDMENT
5.....	2	A-000188.....	1/4" X 2" X 2" BACKING PLATE

**IMPORTANT:** All baseplates **must** be assembled with all the bolts left loose for final adjustment and positioning (before tightening) unless otherwise instructed. All bolts **must** be torqued for proper strength. If more than one bolt is used per fastening point, the diagram may only show one. Use flat washers over all slotted holes and lock washers on all fasteners.

## WARNING

Failure to heed these warnings or follow the installation instructions may result in a voided warranty, loss of towed vehicle, personal injury or death.

- Do not weld or modify this baseplate or its components. Welding or modification will void the warranty.
- Do not use this document as a basis to design/fabricate a baseplate, as it may not show all parts or structural components.
- We strongly recommend professional installation.
- If the towed vehicle has been in an accident, it must be properly repaired before attaching the baseplate. Do not install the baseplate if any structural frame damage is found.
- The installer must use all bolts and parts supplied. If running changes were made by the vehicle manufacturer after this kit was designed, some bolts or other fasteners may no longer be the correct size. It is the installer's responsibility to verify this kit is securely fastened to the vehicle.
- Use Loctite® Red on all bolts used to secure this baseplate. Torque all bolts to the specifications found at the end of these instructions. Do not over-torque the bolts or failure may occur.
- The installer must inspect the baseplate to ensure adequate clearance, particularly around hoses, air conditioner lines, radiators, etc. or non-warranty failure may result.
- Roadmaster manufactures many styles of baseplates. If your baseplate has removable arms, they must be removed before driving the vehicle, unless the arms can be pinned or padlocked in place. If not secured, the arms could vibrate out.
- Some motorhome chassis have such a tight turning radius that you can damage your motorhome, towed vehicle, tow bar or baseplate while turning sharply. Before getting on the road, test your turning radius in an empty parking lot. Turning too sharply could

result in non-warranty damage to your towing system, motorhome and/or towed vehicle.

- Do not back up with the towed vehicle attached or non-warranty damage will occur to your towing system or vehicles.
- The safety cables must connect the towing vehicle to the towed vehicle frame to frame, with the cables crossed, with enough slack for sharp turns. See cable instructions for proper routing. Failure to do so will result in non-warranty damage and/or the loss of the towed vehicle.
- This kit is designed for use with ROADMASTER tow bars and ROADMASTER adapters only. Using this kit with other brands, without an approved ROADMASTER adapter, may result in non-warranty damage or injury.
- Receiver extensions and out-of-level towing situations of 3 inches or more. This can cause the system to swing much higher and lower, causing excessive strain on the tow bar, baseplate and frame. That can cause the towing system to fail, causing property damage, personal injury or even death. If you must use a receiver extension or drop hitch to tow, it will reduce your receiver's weight capacity by 1/3 to avoid damaging your system. Never use more than one extension and/or drop hitch, as this will void your warranty.
- Every 3,000 miles, the owner must inspect all mounting points for cracks or fatigue, and check the fasteners for proper torque, according to the bolt torque requirements chart on the last page of these instructions.
- The owner must follow the vehicle manufacturer's instructions to prepare the vehicle for towing. Failure to do so may cause severe damage to the vehicle.
- This baseplate is only warranted for the original installation. Installing a used baseplate on another vehicle is not recommended and will void the warranty.



# BASEPLATE KIT INSTALLATION INSTRUCTIONS

**KIT# 497-3**

04/08/04

ROADMASTER, Inc. 6110 NE 127th Ave. Vancouver, WA 98682 360-896-0407 fax 360-735-9300 www.roadmasterinc.com

This is one of our MX series brackets, which allows the visible front portion of the brackets to be easily removed from the front of the vehicle. The kit consists of the main receiver braces, front braces and a hardware pack. The receiver brace mounts to the bottom of the frame rails on each side and extend forward through the factory tow loop area in the bumper fascia.

Start by laying the kit out according to the illustration. This will give you a visual idea of how the kit installs and also confirm that the kit components are present and accounted for.

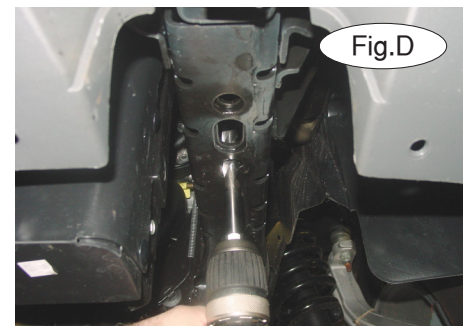
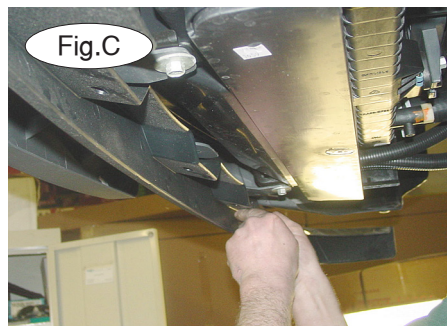

1. **Important:** please use all supplied bolts and parts and read all instructions carefully before beginning this installation. The majority of questions you may have can be answered within the text, and proper installation will ensure safe and secure travel. Now, begin the installation. Start by removing the lower air dam (11 plastic fasteners) (Fig.B,C). Note: the lower air dam can be left off or trimmed to fit and reinstalled after the last step.

2. Look under the frame rails on each side and locate two elongated holes, using these holes as a drill guide, drill two 5/8" holes through the top of each frame rail (Fig.D).

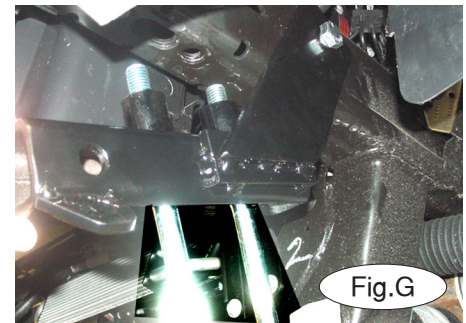
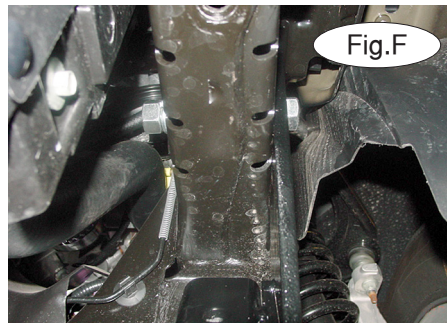
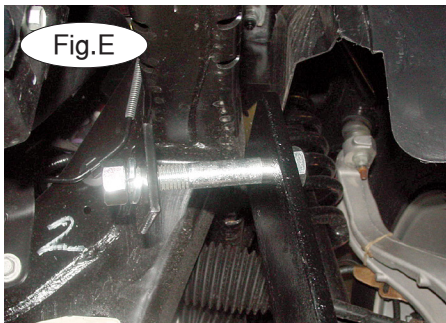

3. Working on one side at a time, take a receiver brace and hold under the frame over the slotted holes with the rear side mount over a existing frame hole. Bolt through the rear most mounting hole and the frame with a 5/8" x 4" bolt, 2x2" backing plate, lock washer and nut (Fig.E,F).

4. Now bolt through the bottom of the receiver brace and the frame with a two 5/8" x 9" bolts (Fig.G), using 5/8" flat washers, lock washers and nuts on the top of the frame (Fig.H,I).



# BASEPLATE KIT INSTALLATION INSTRUCTIONS

**KIT# 497-3**

04/08/04

ROADMASTER, Inc. 6110 NE 127th Ave. Vancouver, WA 98682 360-896-0407 fax 360-735-9300 www.roadmasterinc.com

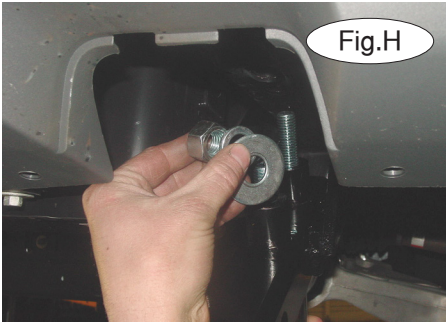

Fig.H

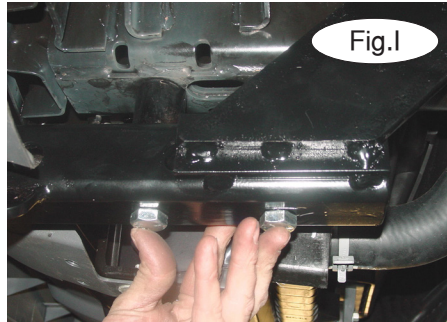

Fig.I

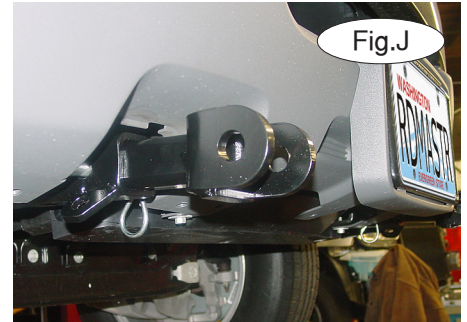

Fig.J

5. Repeat steps 2 through 4 for the remaining side.
6. Torque all bolts to the specifications below.
7. Insert the front braces into the receiver braces and pin with 5/8" draw pins and 1/8" spring pins (Fig.J).
8. Install the tow bar according to the manufacturer's instructions.
9. Attach the safety cables to the main receiver brace.

## BOLT TORQUE REQUIREMENTS

Note: The torque values represented below are intended as general guidelines. Torque requirements for specific applications may vary. Roadmaster does not warrant this information to be accurate for all applications and disclaims all liability for any claims or damages which may result from its use.

### STANDARD BOLTS

Thread Size	Grade	Torque
5/16.....	5.....	13 ft./lb.
3/8.....	5.....	23 ft./lb.
7/16.....	5.....	37 ft./lb.
1/2.....	5.....	56 ft./lb.
5/8.....	5.....	150 ft./lb.

### METRIC BOLTS

Thread Size	Grade	Plated / Unplated
8mm-1.0.....	8.8.....	20 ft./lb. 18 ft./lb.
8mm-1.25.....	8.8.....	19 ft./lb. 18 ft./lb.
10mm-1.25.....	8.8.....	38 ft./lb. 36 ft./lb.
10mm-1.5.....	8.8.....	37 ft./lb. 35 ft./lb.

### METRIC BOLTS

Thread Size	Grade	Plated / Unplated
12mm-1.25.....	8.8.....	70 ft./lb. 65 ft./lb.
12mm-1.5.....	8.8.....	66 ft./lb. 61 ft./lb.
12mm-1.75.....	8.8.....	65 ft./lb. 60 ft./lb.
14mm-2.0.....	8.8.....	104 ft./lb. 97 ft./lb.

All illustrations and specifications contained herein are based on the latest information available at the time of publication approval. ROADMASTER, INC. reserves the right to make changes at any time without notice in material, specification and models or to discontinue models.