



BASEPLATE KIT INSTALLATION INSTRUCTIONS

KIT# 916-3

04/15/14
KS

ROADMASTER, Inc. 6110 NE 127th Ave. Vancouver, WA 98682 360-896-0407 fax 360-735-9300 www.roadmasterinc.com

Important
Note: this bracket will not accommodate the Guardian rock shield, some models of the Tow Defender, Stowaway or the StowMaster and StowMaster All Terrain tow bars.

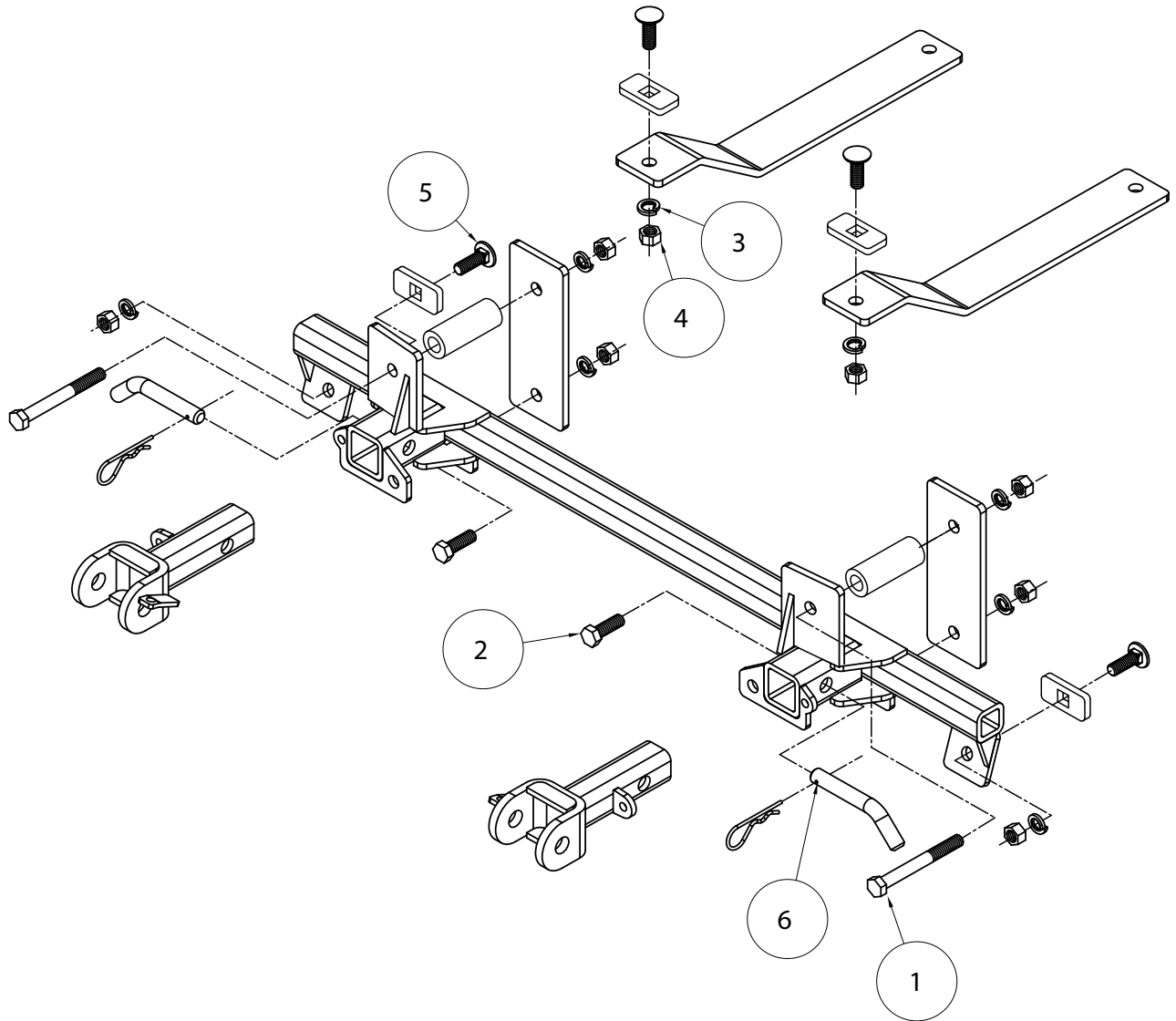

Item	Qty.	Length	Width	Description	Part #
1.....2.....	4 1/2"	1/2"		BOLT.....	350106-00
2.....2.....	1 1/2"	1/2"		BOLT.....	350095-00
3.....8.....		1/2"		LOCK WASHER.....	350309-00
4.....8.....		1/2"		NUT.....	350258-00
5.....4.....	1 1/2"	1/2"		CARRIAGE BOLT.....	350362-00
6.....2.....				DRAW PIN/ SPRING PIN.....	357035-00



BASEPLATE KIT INSTALLATION INSTRUCTIONS

KIT# 916-3

04/15/14
KS

ROADMASTER, Inc. 6110 NE 127th Ave. Vancouver, WA 98682 360-896-0407 fax 360-735-9300 www.roadmasterinc.com

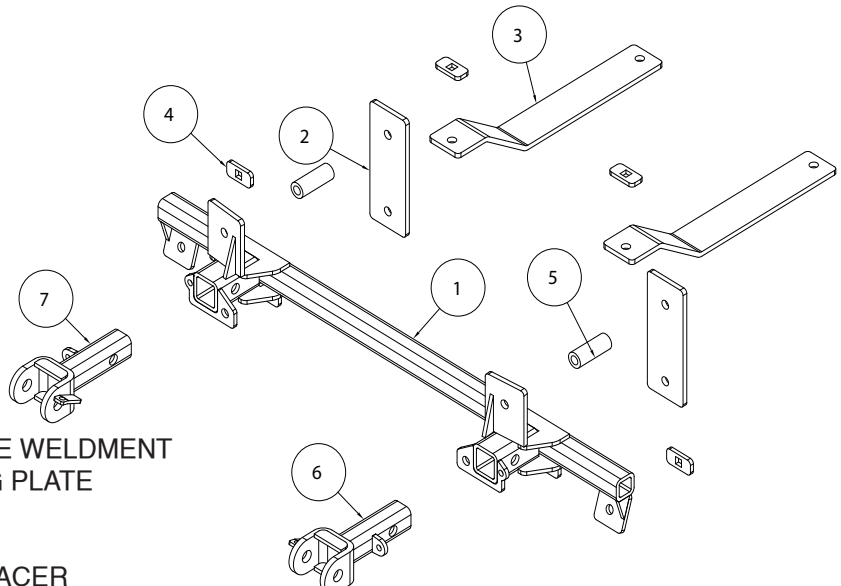

Item	Qty.	Part #	Description
1.....	1.....	C-000684	RECEIVER BRACE WELDMENT
2.....	2.....	A-001163	REAR MOUNTING PLATE
3.....	2.....	B-000471	BRACE PLATE
4.....	4.....	A-000040	BACKING PLATE
5.....	2.....	A-001168	ROUND TUBE SPACER
6.....	1.....	C-001144	DRIVER SIDE ARM BRACE WELDMENT
7.....	1.....	C-001145	PASSENGER SIDE ARM BRACE WELDMENT

IMPORTANT: All baseplates **must** be assembled with all the bolts left loose for final adjustment and positioning (before tightening) unless otherwise instructed. All bolts **must** be torqued for proper strength. If more than one bolt is used per fastening point, the diagram may only show one. Use flat washers over all slotted holes and lock washers on all fasteners.

WARNING

Failure to heed these warnings or follow the installation instructions may result in a voided warranty, loss of towed vehicle, personal injury or death.

- Do not weld or modify this baseplate or its components. Welding or modification will void the warranty.
- Do not use this document as a basis to design/fabricate a baseplate, as it may not show all parts or structural components.
- We strongly recommend professional installation.
- If the towed vehicle has been in an accident, it must be properly repaired before attaching the baseplate. Do not install the baseplate if any structural frame damage is found.
- The installer must use all bolts and parts supplied. If running changes were made by the vehicle manufacturer after this kit was designed, some bolts or other fasteners may no longer be the correct size. It is the installer's responsibility to verify this kit is securely fastened to the vehicle.
- Use Loctite® Red on all bolts used to secure this baseplate. Torque all bolts to the specifications found at the end of these instructions. Do not over-torque the bolts or failure may occur.
- The installer must inspect the baseplate to ensure adequate clearance, particularly around hoses, air conditioner lines, radiators, etc. or non-warranty failure may result.
- Roadmaster manufactures many styles of baseplates. If your baseplate has removable arms, they must be removed before driving the vehicle, unless the arms can be pinned or padlocked in place. If not secured, the arms could vibrate out.
- Some motorhome chassis have such a tight turning radius that you can damage your motorhome, towed vehicle, tow bar or baseplate while turning sharply. Before getting on the road, test your turning radius in an empty parking lot. Turning too sharply could

result in non-warranty damage to your towing system, motorhome and/or towed vehicle.

- Do not back up with the towed vehicle attached or non-warranty damage will occur to your towing system or vehicles.
- The safety cables must connect the towing vehicle to the towed vehicle frame to frame, with the cables crossed, with enough slack for sharp turns. See cable instructions for proper routing. Failure to do so will result in non-warranty damage and/or the loss of the towed vehicle.
- This kit is designed for use with ROADMASTER tow bars and ROADMASTER adapters only. Using this kit with other brands, without an approved ROADMASTER adapter, may result in non-warranty damage or injury.
- Receiver extensions and out-of-level towing situations of 3 inches or more. This can cause the system to swing much higher and lower, causing excessive strain on the tow bar, baseplate and frame. That can cause the towing system to fail, causing property damage, personal injury or even death. If you must use a receiver extension or drop hitch to tow, it will reduce your receiver's weight capacity by 1/3 to avoid damaging your system. Never use more than one extension and/or drop hitch, as this will void your warranty.
- Every 3,000 miles, the owner must inspect all mounting points for cracks or fatigue, and check the fasteners for proper torque, according to the bolt torque requirements chart on the last page of these instructions.
- The owner must follow the vehicle manufacturer's instructions to prepare the vehicle for towing. Failure to do so may cause severe damage to the vehicle.
- This baseplate is only warranted for the original installation. Installing a used baseplate on another vehicle is not recommended and will void the warranty.



BASEPLATE KIT INSTALLATION INSTRUCTIONS

KIT# 916-3

04/15/14
KS

ROADMASTER, Inc. 6110 NE 127th Ave. Vancouver, WA 98682 360-896-0407 fax 360-735-9300 www.roadmasterinc.com

1. This bracket kit is one of our MX series, which is designed to be partly removable. The kit consists of a main receiver brace, two side braces, front braces and a hardware pack. The main receiver brace mounts below the bumper core behind the front bumper fascia. The side braces install behind the fascia to the sides of the receiver brace, then back to the front tie down loops on each side. The front braces install in the receiver braces (Fig.A). Layout the kit, according to the illustration. This will give you a visual idea of how the kit installs and also confirm that the kit components are present and accounted for.

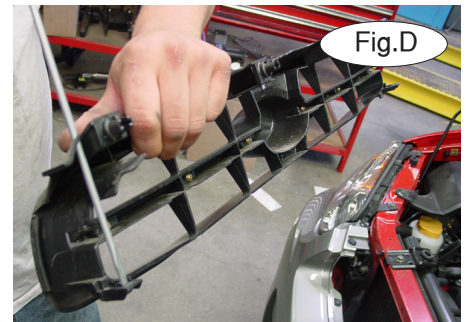
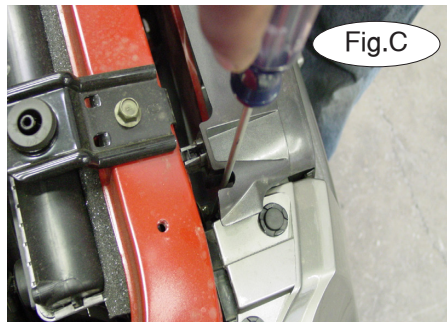
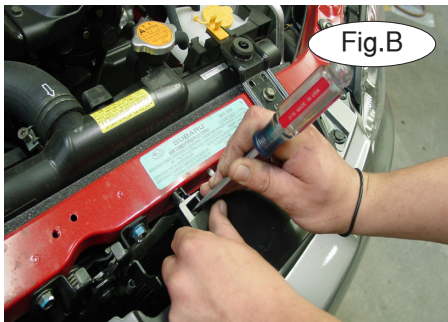

2. **Important:** please use all supplied bolts and parts and read all instructions carefully before beginning this installation. The majority of questions you may have can be answered within the text, and proper installation will ensure safe and secure travel. Now, begin the installation. Start by removing the grille. Use a screwdriver to depress four built-in catches on the top of the grille and one in each bottom corner. Then, lift out and set aside (Fig.B,C,D).

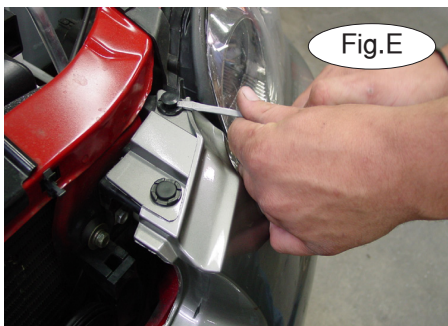

3. Remove nine plastic fasteners from the top of the fascia (Fig.E).
4. Remove a lower plastic fastener in each fender well (Fig.F) then two more underneath each splash panel (Fig.G).



BASEPLATE KIT INSTALLATION INSTRUCTIONS

KIT# 916-3

04/15/14
KS

ROADMASTER, Inc. 6110 NE 127th Ave. Vancouver, WA 98682 360-896-0407 fax 360-735-9300 www.roadmasterinc.com



Fig.H

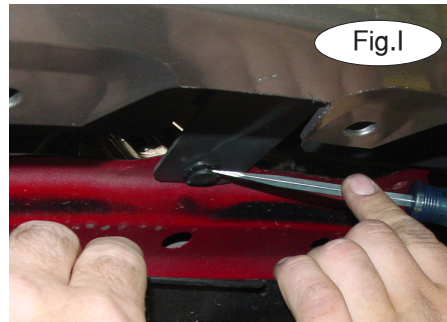

Fig.I



Fig.J

5. Remove the fascia/fender junction fastener on each side (Phillips head) (Fig.H) then one center fastener (Fig.I) and a Phillips head screw.
6. Remove an additional plastic fastener near the driving lights on each side (Fig.J) then disconnect the driving lights.

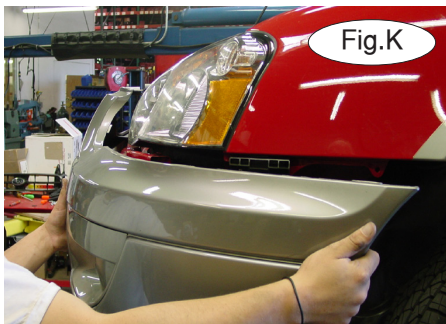

Fig.K



Fig.L

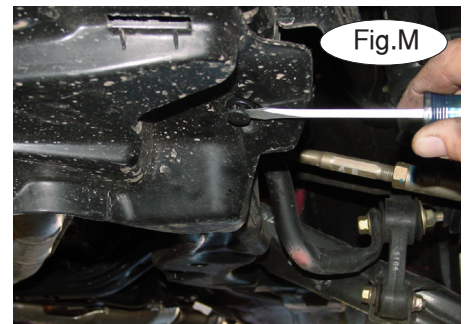

Fig.M

7. Pull the sides of the fascia out and forward to remove, and then set aside (Fig.K). Now, remove the foam shock absorption (Fig.L).
8. Remove three bottom gravel guard fasteners (12mm head); one on each side and one in the middle (Fig.M).

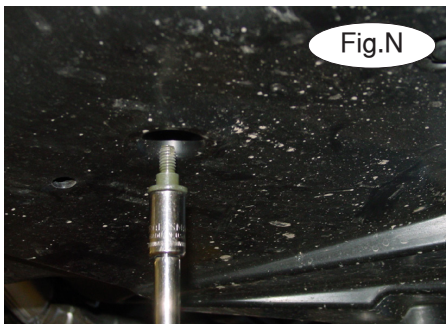

Fig.N

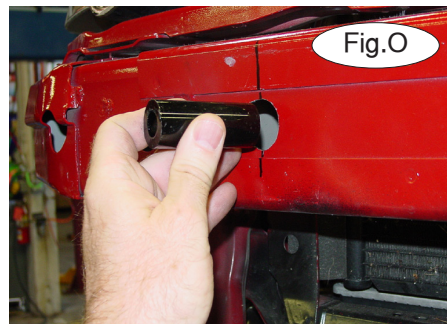

Fig.O

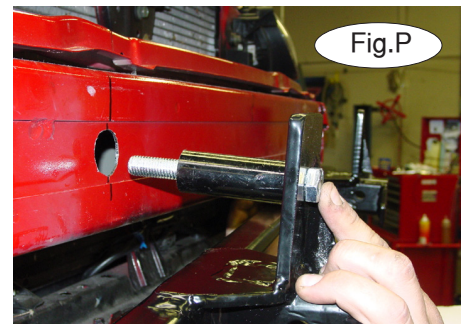

Fig.P

9. Remove four more plastic fasteners in the bottom splash panel and then set the gravel guard aside (Fig.N).
10. Locate two large holes on each side in the front of the bumper core. Enlarge the passenger side forwardmost hole so that a tube spacer can be inserted into the front of the bumper core (Fig.O).
11. Using two of the supplied $\frac{1}{2}$ " x $4\frac{1}{2}$ " bolts, two $2\frac{5}{8}$ " tube spacers, two $\frac{1}{4}$ " x 3" x 8" rear mounting plates, lock washers and nuts, insert the bolts in the brace mounting holes and one spacer on the passenger side as shown (Fig.P). Hold the main receiver brace under and in front of the bumper core (Fig.Q) with the bolts and one spacer in the front holes of the bumper core. Insert the driver side spacer in the back of the bumper core over the driver side bolt. Install the rear mounting plates on the bolts behind the bumper core (Fig.R) and finish with the $\frac{1}{2}$ " lock washers and nuts (Fig.S).



BASEPLATE KIT INSTALLATION INSTRUCTIONS

KIT# 916-3

04/15/14
KS

ROADMASTER, Inc. 6110 NE 127th Ave. Vancouver, WA 98682 360-896-0407 fax 360-735-9300 www.roadmasterinc.com

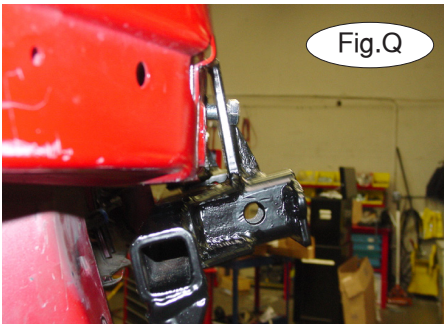

Fig.Q

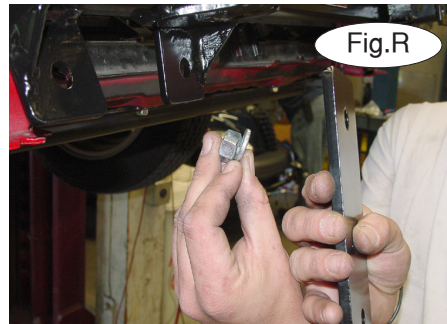

Fig.R

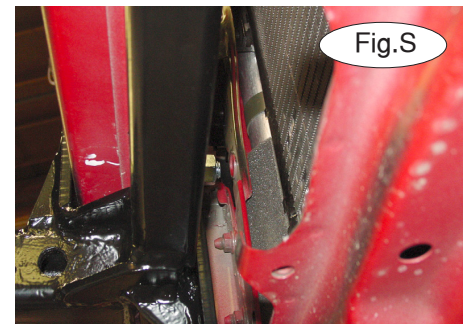

Fig.S

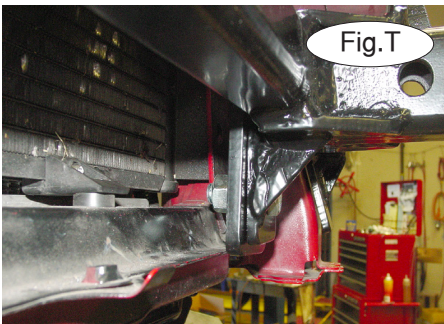

Fig.T

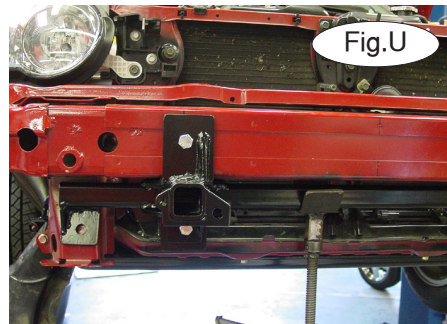

Fig.U

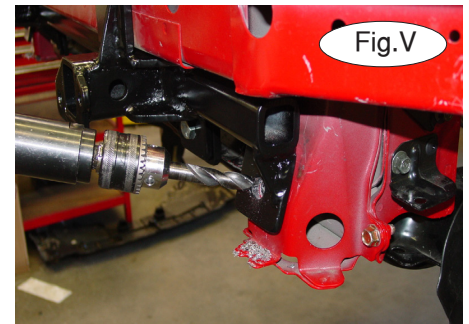

Fig.V

12. Bolt through the bottom of the rear mounting plates with $\frac{1}{2}$ " x $1\frac{1}{2}$ " bolts, lock washers and nuts (Fig.T).
13. Push or clamp the receiver brace firmly to the bottom of the bumper core and then tighten all the bolts installed in steps 11 and 12 to the bolt torque requirements found on the last page of these instructions (Fig.U).
14. Using the receiver brace as a drill template, drill a $\frac{17}{32}$ " hole in the front of the frame on each side (Fig.V).

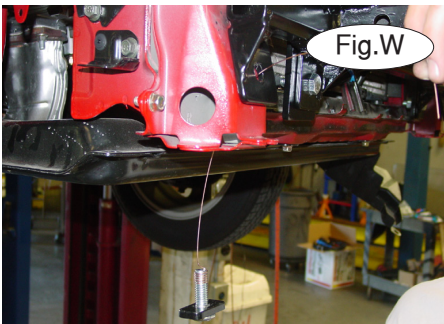

Fig.W

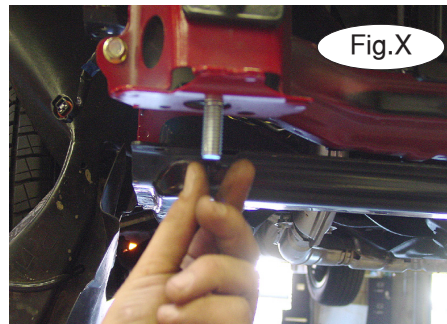

Fig.X

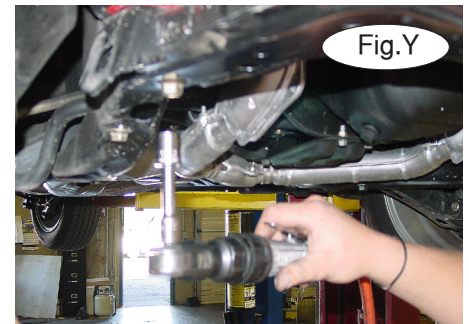

Fig.Y

15. Using two of the supplied $\frac{1}{2}$ " x $1\frac{1}{2}$ " carriage bolts, 1" x 2" backing plates, $\frac{1}{2}$ " lock washers and nuts, fishwire the carriage bolts and backing plates into the drilled holes through access holes in the bottom of the frame (Fig.W). Finish by tightening the bolts to the bolt torque requirements found at the end of these instructions. *Note:* if the hole doesn't exist in the bottom of the frame, use the large access hole in the side of the frame instead.
16. On each side, use one of the $\frac{1}{2}$ " x $1\frac{1}{2}$ " carriage bolts and 1" x 2" backing plates and place them through the hole in the bottom of the frame rail (Fig.X). *Note:* due to manufacturing variances, the hole in the bottom of the frame rail may not exist. If this is the case, use the forwardmost pre-existing hole in the lower brace plate (installed in steps 17-19) as a template for drilling the hole into the frame.
17. Support the lower front subframe (Fig.X) then, working on one side at a time, remove a subframe bolt (Fig.Y).



BASEPLATE KIT INSTALLATION INSTRUCTIONS

KIT# 916-3

04/15/14
KS

ROADMASTER, Inc. 6110 NE 127th Ave. Vancouver, WA 98682 360-896-0407 fax 360-735-9300 www.roadmasterinc.com

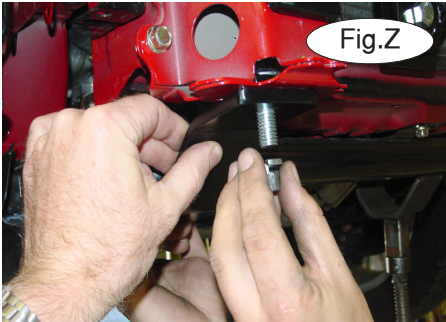

Fig.Z

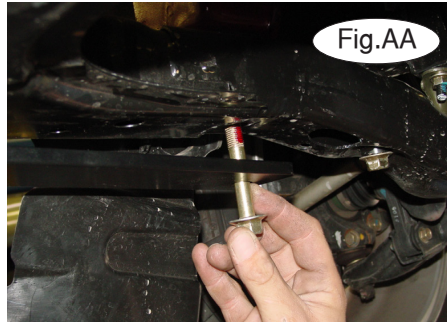

Fig.AA

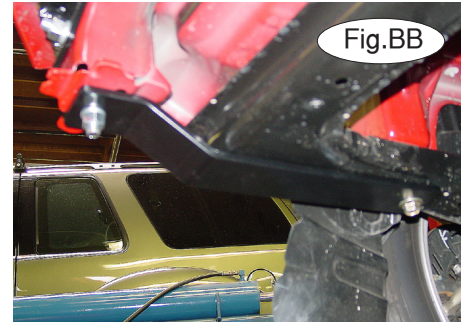

Fig.BB

18. Place the front of the brace plate over the bolt you installed in step 16 and then finish with a 1/2" lock washer and nut (Fig.Z).
19. Apply Loctite® Red on all nuts and bolts, as well as the subframe bolt (Fig.AA) then reinstall and torque both bolts to the bolt torque requirements found at the end of these instructions (Fig.BB).



Fig.CC



Fig.DD



Fig.EE

20. Repeat steps 17 through 19 for the remaining side.

21. Mark and cut the shock absorption foam to clear the upper mounts (Fig.CC).

22. Trial fit the fascia and mark the center rib and sides of the lower opening then trim to fit as shown (Fig.DD,EE).

23. Reinstall the foam and fascia reversing steps 2 through 7 (Fig.FF,GG).

24. Trim the front of the fender well splash panels to fit around the braces (Fig.HH,II). Also, trim the center gravel guard as needed to fit.



Fig.FF

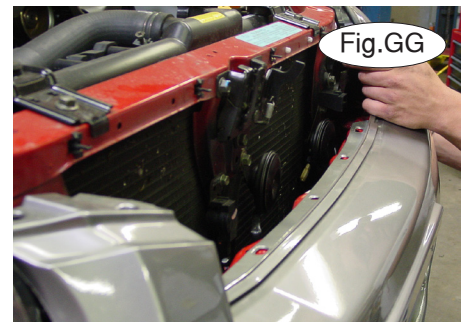

Fig.GG

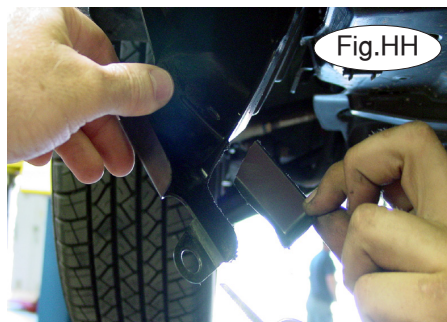

Fig.HH

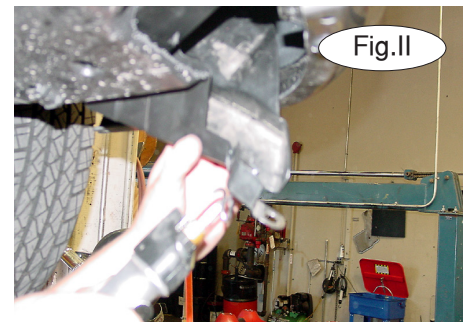

Fig.II



BASEPLATE KIT INSTALLATION INSTRUCTIONS

KIT# 916-3

04/15/14

KS

ROADMASTER, Inc. 6110 NE 127th Ave. Vancouver, WA 98682 360-896-0407 fax 360-735-9300 www.roadmasterinc.com

- 25. Insert the front braces in the receiver braces and secure using 5/8" draw pins and 1/8" spring pins (Fig.JJ).
- 26. Install the tow bar to the mounting bracket according to the manufacturer's instructions. Attach the safety cables to the main receiver brace.

BOLT TORQUE REQUIREMENTS

Note: The torque values represented below are intended as general guidelines. Torque requirements for specific applications may vary. Roadmaster does not warrant this information to be accurate for all applications and disclaims all liability for any claims or damages which may result from its use.

STANDARD BOLTS

Thread Size	Grade	Torque
5/16.....	5.....	13 ft./lb.
3/8.....	5.....	23 ft./lb.
7/16.....	5.....	37 ft./lb.
1/2.....	5.....	56 ft./lb.
5/8.....	5.....	150 ft./lb.

METRIC BOLTS

Thread Size	Grade	Plated / Unplated
8mm-1.0	8.8	20 ft./lb. 18 ft./lb.
8mm-1.25	8.8	19 ft./lb. 18 ft./lb.
10mm-1.25	8.8	38 ft./lb. 36 ft./lb.
10mm-1.5	8.8	37 ft./lb. 35 ft./lb.

METRIC BOLTS

Thread Size	Grade	Plated / Unplated
12mm-1.25	8.8	70 ft./lb. 65 ft./lb.
12mm-1.5	8.8	66 ft./lb. 61 ft./lb.
12mm-1.75	8.8	65 ft./lb. 60 ft./lb.
14mm-2.0	8.8	104 ft./lb. 97 ft./lb.

All illustrations and specifications contained herein are based on the latest information available at the time of publication approval. ROADMASTER, INC. reserves the right to make changes at any time without notice in material, specification and models or to discontinue models.