



BASEPLATE KIT INSTALLATION INSTRUCTIONS

KIT# 3160-3B

03/25/15
KS

ROADMASTER, Inc. 6110 NE 127th Ave. Vancouver, WA 98682 360-896-0407 fax 360-735-9300 www.roadmasterinc.com

Important
Note: this bracket will not accommodate the Guardian rock shield, some models of the Tow Defender, or the StowMaster and StowMaster All Terrain tow bars.

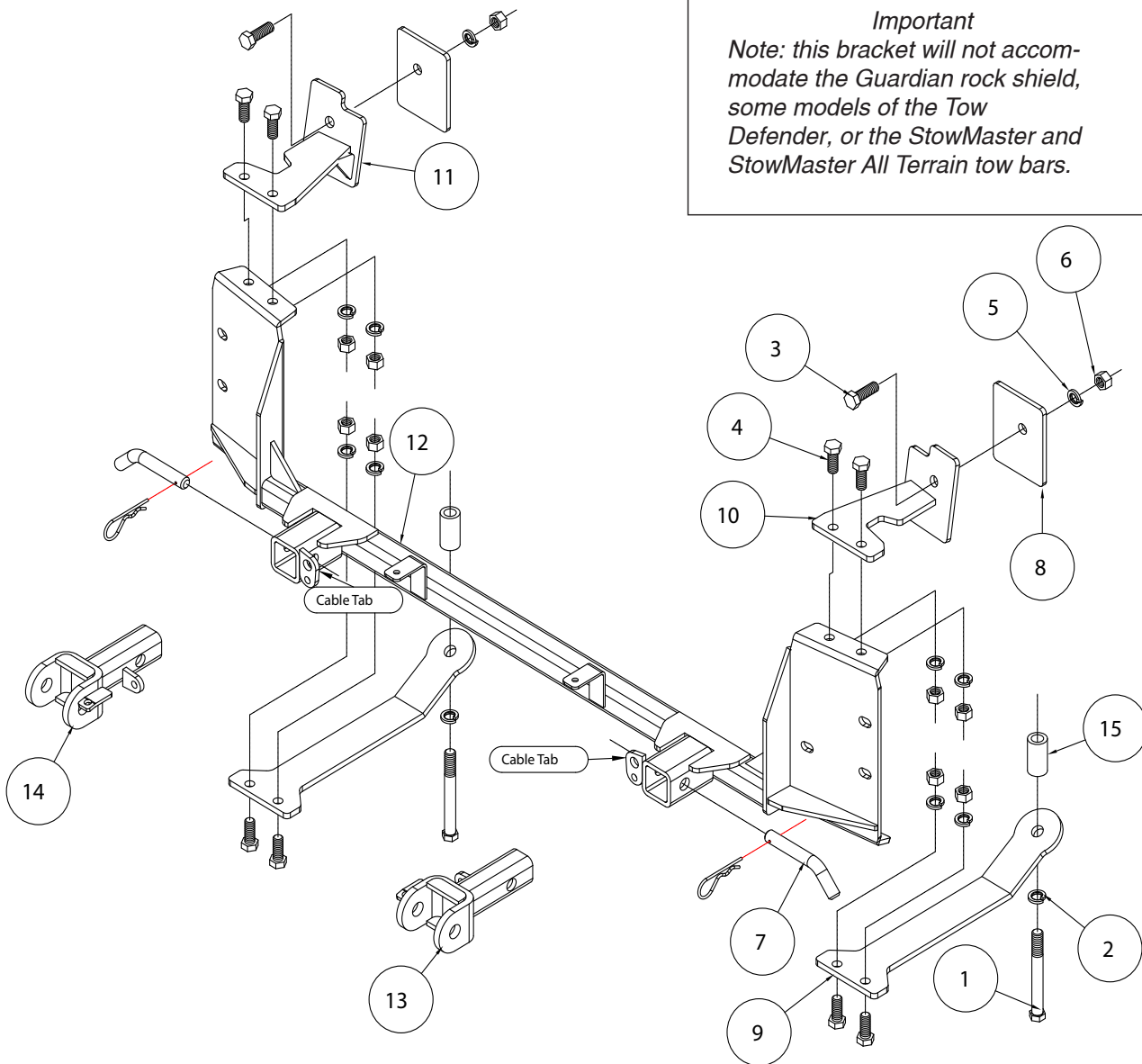

ITEM	QTY	NAME	PART #
1.....2.....	2.....	14mm x 2.0 x 160 mm BOLT	355910-16
2.....2.....	2.....	14mm LOCK WASHER	355740-00
3.....2.....	2.....	1/2" x 1 1/2" BOLT.....	350095-00
4.....8.....	8.....	1/2" x 1 1/4" BOLT.....	350094-00
5.....10.....	10.....	1/2" LOCK WASHER	350309-00
6.....10.....	10.....	1/2" HEX NUT	350258-00
7.....2.....	2.....	DRAW PIN W/ CLIP.....	357035-00
8.....2.....	2.....	1/4" x 3 1/2' x 4 1/2" BACKING PLATE.....	A-002964
9.....2.....	2.....	BRACE	B-002454
10.....1.....	1.....	DRIVER SIDE BRACE	C-001879
11.....1.....	1.....	PASSENGER SIDE BRACE.....	C-001880
12.....1.....	1.....	MAIN RECEIVER	C-001881C
13.....1.....	1.....	DRIVER SIDE MX ARM	C-001876
14.....1.....	1.....	PASSENGER SIDE MX ARM.....	C-001877
15.....2.....	2.....	1" x 1 7/8" SPACER	A-004511
16.....4.....	4.....	ZIP TIE.....	300140-8



BASEPLATE KIT INSTALLATION INSTRUCTIONS

KIT# 3160-3B

03/25/15
KS

ROADMASTER, Inc. 6110 NE 127th Ave. Vancouver, WA 98682 360-896-0407 fax 360-735-9300 www.roadmasterinc.com

This bracket kit is one of our MX series, which allows the visible front portion of the brackets to be easily removed (Fig.A and Fig.B). The kit consists of the main receiver brace, removable front braces and a hardware pack.

The main receiver brace mounts to the front frame and bumper core on each side. The removable front braces insert into the receivers on each side and are secured with draw pins.

Before starting the installation, lay out the kit components in order, as they will be used. This will give you a visual idea of how the components work, and will also confirm that everything is present and accounted for.



IMPORTANT: All baseplates **must** be assembled with all the bolts left loose for final adjustment and positioning (before tightening) unless otherwise instructed. All bolts **must** be torqued for proper strength. If more than one bolt is used per fastening point, the diagram may only show one. Use flat washers over all slotted holes and lock washers on all fasteners.

WARNING

Failure to heed these warnings or follow the installation instructions may result in a voided warranty, loss of towed vehicle, personal injury or death.

- Do not weld or modify this baseplate or its components. Welding or modification will void the warranty.
- Do not use this document as a basis to design/fabricate a baseplate, as it may not show all parts or structural components.
- We strongly recommend professional installation.
- If the towed vehicle has been in an accident, it must be properly repaired before attaching the baseplate. Do not install the baseplate if any structural frame damage is found.
- The installer must use all bolts and parts supplied. If running changes were made by the vehicle manufacturer after this kit was designed, some bolts or other fasteners may no longer be the correct size. It is the installer's responsibility to verify this kit is securely fastened to the vehicle.
- Use Loctite® Red on all bolts used to secure this baseplate. Torque all bolts to the specifications found at the end of these instructions. Do not over-torque the bolts or failure may occur.
- The installer must inspect the baseplate to ensure adequate clearance, particularly around hoses, air conditioner lines, radiators, etc. or non-warranty failure may result.
- Roadmaster manufactures many styles of baseplates. If your baseplate has removable arms, they must be removed before driving the vehicle, unless the arms can be pinned or padlocked in place. If not secured, the arms could vibrate out.
- Some motorhome chassis have such a tight turning radius that you can damage your motorhome, towed vehicle, tow bar or baseplate while turning sharply. Before getting on the road, test your turning radius in an empty parking lot. Turning too sharply could result in non-warranty damage to your towing system, motorhome and/or towed vehicle.
- Do not back up with the towed vehicle attached or non-warranty damage will occur to your towing system or vehicles.
- The safety cables must connect the towing vehicle to the towed vehicle frame to frame, with the cables crossed, with enough slack for sharp turns. See cable instructions for proper routing. Failure to do so will result in non-warranty damage and/or the loss of the towed vehicle.
- This kit is designed for use with ROADMASTER tow bars and ROADMASTER adapters only. Using this kit with other brands, without an approved ROADMASTER adapter, may result in non-warranty damage or injury.
- Receiver extensions and out-of-level towing situations of 3 inches or more. This can cause the system to swing much higher and lower, causing excessive strain on the tow bar, baseplate and frame. That can cause the towing system to fail, causing property damage, personal injury or even death. If you must use a receiver extension or drop hitch to tow, it will reduce your receiver's weight capacity by 1/3 to avoid damaging your system. Never use more than one extension and/or drop hitch, as this will void your warranty.
- Every 3,000 miles, the owner must inspect all mounting points for cracks or fatigue, and check the fasteners for proper torque, according to the bolt torque requirements chart on the last page of these instructions.
- The owner must follow the vehicle manufacturer's instructions to prepare the vehicle for towing. Failure to do so may cause severe damage to the vehicle.
- This baseplate is only warranted for the original installation. Installing a used baseplate on another vehicle is not recommended and will void the warranty.



BASEPLATE KIT INSTALLATION INSTRUCTIONS

KIT# 3160-3B

03/25/15
KS

ROADMASTER, Inc. 6110 NE 127th Ave. Vancouver, WA 98682 360-896-0407 fax 360-735-9300 www.roadmasterinc.com



1. **Important:** please use all supplied bolts and parts and read all instructions carefully before beginning this installation. The majority of questions you may have can be answered within the text, and proper installation will ensure safe and secure travel. Now, begin the installation. Remove two plastic fasteners and either four 7mm (head) screws or four T20 torx bolts attaching the top of the fascia to the core support (Fig.C).



2. On each side, remove one 7mm (head) screw attaching the corner of the fascia to the fender (Fig.D).
3. On each side, remove one T20 Torx screw and three plastic fasteners attaching the fender liner to the fascia (Fig.E).
4. On each side, remove T20 Torx screws attaching the bottom of the fender liners to the fascia (Fig. F – driver's side).
5. Disconnect the fog lights, if the vehicle is so equipped. Pull forward to remove the fascia (Fig.G).

Now, go to the supplemental instructions at this time if the vehicle is equipped with a power steering cooler. If not, continue with step 6.

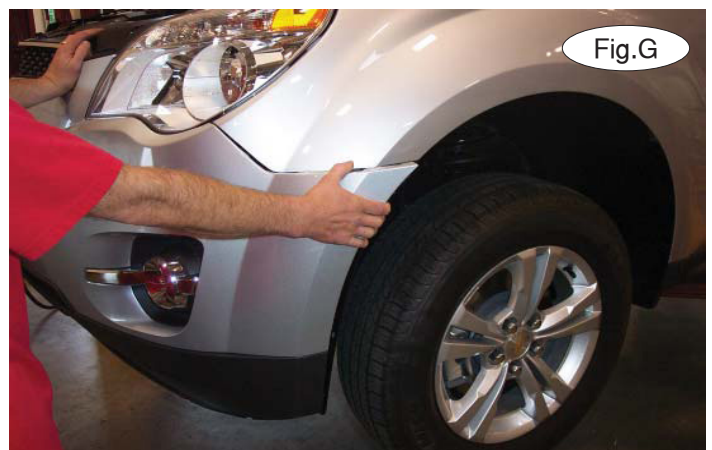



BASEPLATE KIT INSTALLATION INSTRUCTIONS

KIT# 3160-3B

03/25/15
KS

ROADMASTER, Inc. 6110 NE 127th Ave. Vancouver, WA 98682 360-896-0407 fax 360-735-9300 www.roadmasterinc.com



6. Unsnap five plastic clips to remove the wiring harness from the back of the bumper core (Fig.H).

7. On each side, remove four 13mm (head) bolts attaching the bumper core to the frame rails (Fig.I). The bumper core will not be replaced. Retain the bumper core in case the bracket is ever removed.

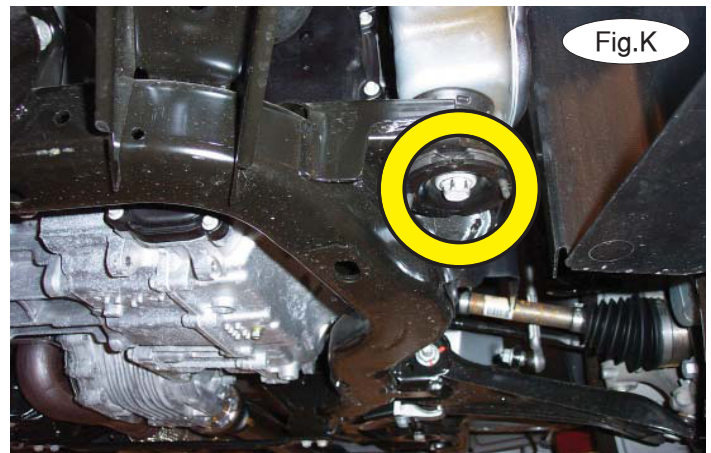

8. Unsnap one plastic clip on each side attaching the wiring harness to the end of the frame rail.

Now, place thread lock on the bolts you removed in the previous step and use them to attach the main receiver brace to the ends of the frame rails (Fig.J).

Tighten the bolts to the bolt torque requirements found at the end of these instructions.

9. Working on the driver's side, remove the 18mm subframe bolt. *Note:* do not remove both subframe bolts without supporting the frame (Fig.K).

10. Place thread lock on one of the supplied 14mm x 2.0 x 160mm bolts, and bolt through the lower rear brace and a 1" x 1 7/8" pipe spacer and into the subframe (Fig.L).

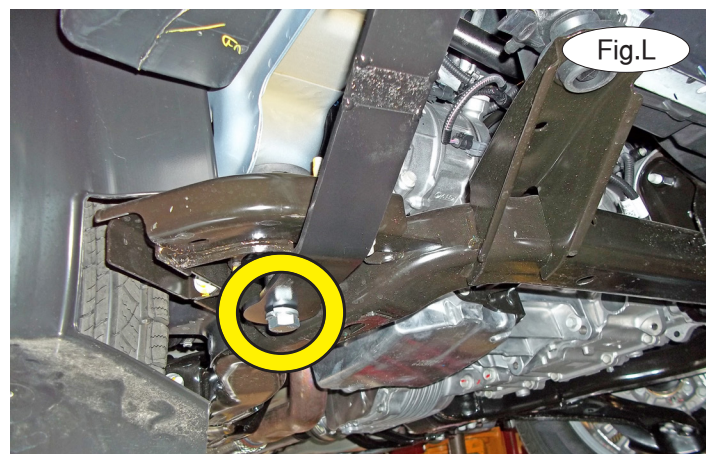



BASEPLATE KIT INSTALLATION INSTRUCTIONS

KIT# 3160-3B

03/25/15
KS

ROADMASTER, Inc. 6110 NE 127th Ave. Vancouver, WA 98682 360-896-0407 fax 360-735-9300 www.roadmasterinc.com

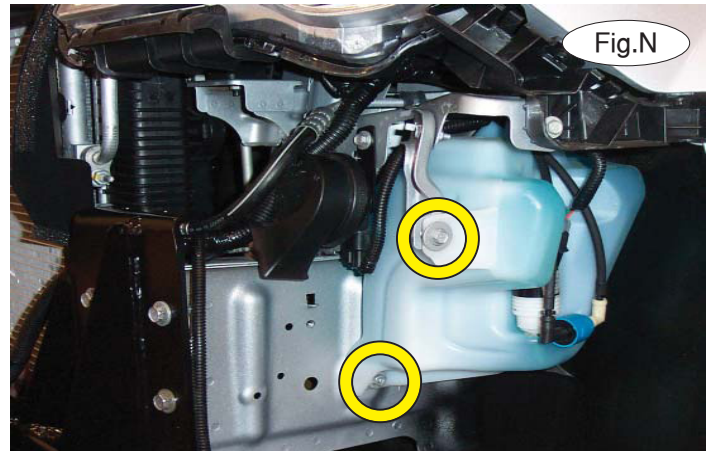
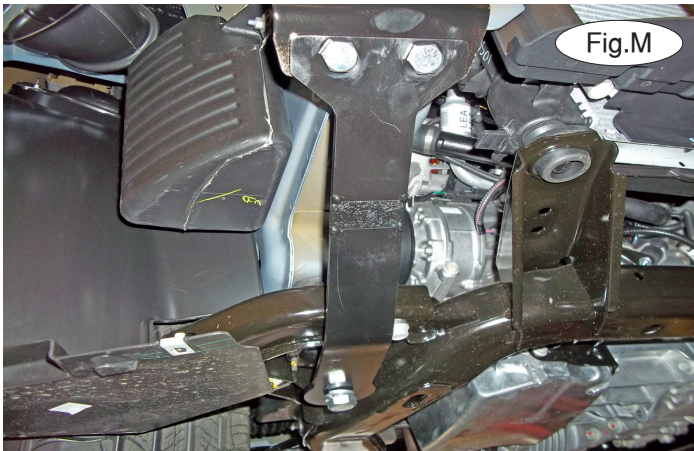

11. Using two of the supplied $\frac{1}{2}$ " x $1\frac{1}{4}$ " bolts, lock washers and nuts, bolt the lower rear brace to the main receiver brace (Fig.M). Tighten the bolts to the bolt torque requirements found at the end of this document.
12. Repeat steps 9 through 11 for the passenger side of the vehicle.
13. Working on the driver's side, loosen the 10mm bolt and 10mm nut attaching the washer bottle to the frame rail (Fig.N).

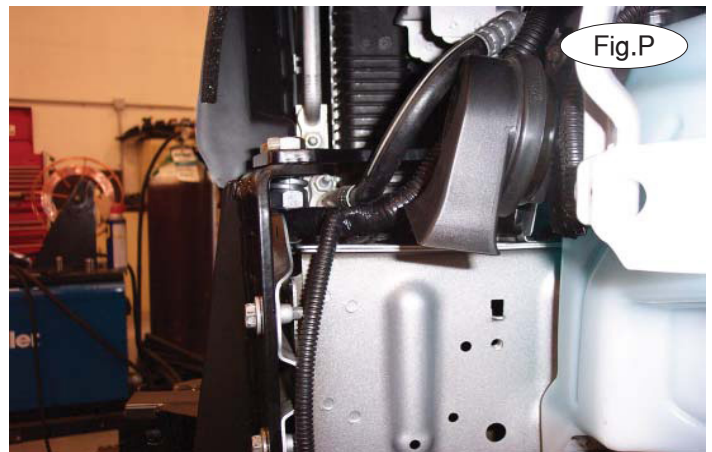
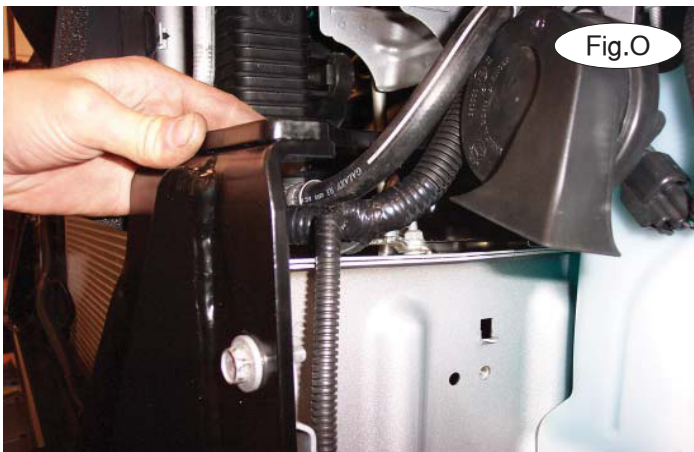

14. Position the upper rear brace over the top of the main receiver brace (Fig.O).
15. Using two of the supplied $\frac{1}{2}$ " x $1\frac{1}{4}$ " bolts, lock washers and nuts, bolt the upper rear brace to the main receiver brace (Fig.P).
16. Place one of the $3\frac{1}{2}$ " x $4\frac{1}{2}$ " backing plates through the opening in the side of the frame behind the upper rear brace (Fig.Q).





BASEPLATE KIT INSTALLATION INSTRUCTIONS

KIT# 3160-3B

03/25/15
KS

ROADMASTER, Inc. 6110 NE 127th Ave. Vancouver, WA 98682 360-896-0407 fax 360-735-9300 www.roadmasterinc.com

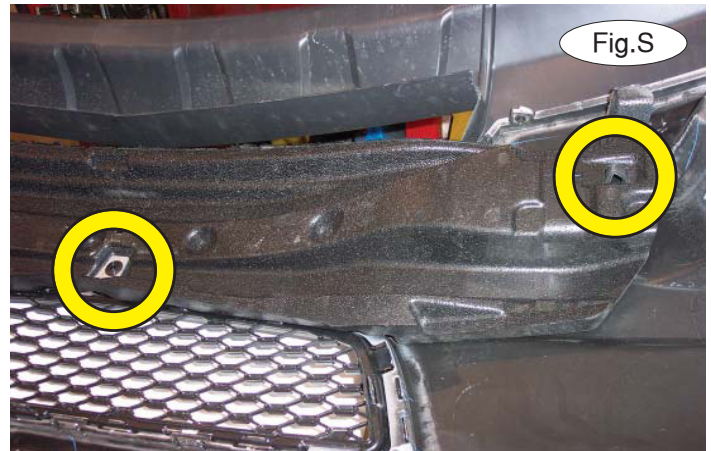

17. Bolt the backing plate into place using one of the supplied $\frac{1}{2}$ " x $1\frac{1}{2}$ " bolts, lock washers and nuts (Fig.R).
18. Torque the bolts to the bolt torque requirements found at the end of this document.

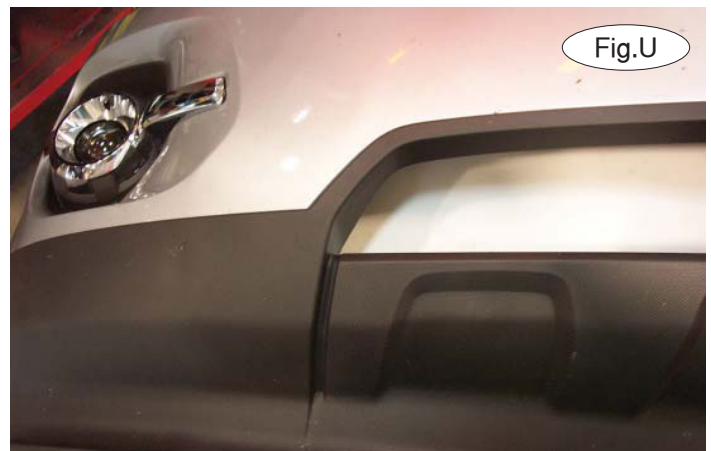

19. Repeat steps 13 through 18 for the passenger side of the vehicle. Now, return to the supplemental instructions at this time, if the vehicle is equipped with a power steering cooler. If not, continue with step 20.

20. Remove the foam shock absorption pad from the back of the fascia by removing two plastic clips and one screw. It will not be replaced. Retain the foam shock absorption pad and its attachment hardware for replacement in case the bracket is ever removed. *Note:* Figure S only shows one clip and the screw.

21. Trim the fascia using the blue lines in Figure T as a reference. Figure U shows the completed trimming.

22. Using four of the supplied zip ties, attach the wiring harness to the main receiver brace (Fig.V).

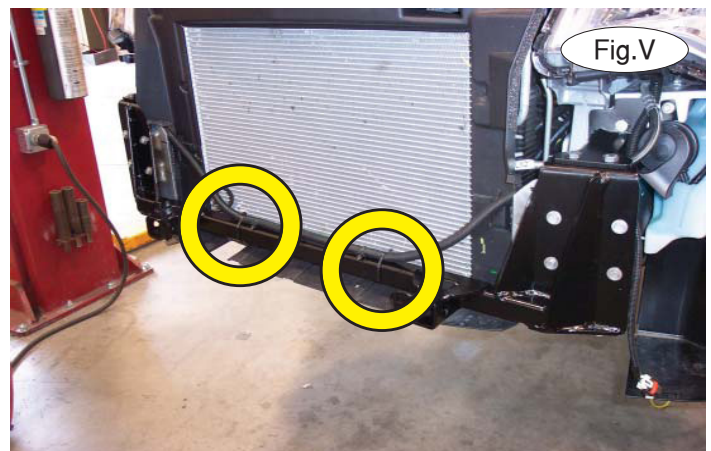



BASEPLATE KIT INSTALLATION INSTRUCTIONS

KIT# 3160-3B

03/25/15
KS

ROADMASTER, Inc. 6110 NE 127th Ave. Vancouver, WA 98682 360-896-0407 fax 360-735-9300 www.roadmasterinc.com

- 23. Reassemble the fascia by reversing steps 1 through 5. Now, return to the supplement to reattach the power steering cooler, if the vehicle is so equipped. If not, continue with step 24.
- 24. Insert the removable front bracket arms into the front receiver braces.
- 25. Install the tow bar to the mounting bracket according to the manufacturer's instructions.

Note: if the bracket is so equipped, the holes in the alignment tabs which are welded to the arms and main receiver braces are for padlocks only. Under no circumstances should you bolt the alignment tabs together. Bolting the alignment tabs together may result in non-warranty damage to the bracket.

BOLT TORQUE REQUIREMENTS

Note: The torque values represented below are intended as general guidelines. Torque requirements for specific applications may vary. Roadmaster does not warrant this information to be accurate for all applications and disclaims all liability for any claims or damages which may result from its use.

STANDARD BOLTS

Thread Size	Grade	Torque
5/16-18	5	13 ft./lb.
3/8-16	5	23 ft./lb.
7/16-14	5	37 ft./lb.
1/2-13	5	57 ft./lb.
5/8-11	5	112 ft./lb.

METRIC BOLTS

Thread Size	Grade	Torque
6mm-1.0	8.8	6 ft./lb.
8mm-1.0	8.8	18 ft./lb.
8mm-1.25	8.8	16 ft./lb.
10mm-1.25	8.8	36 ft./lb.
10mm-1.5	8.8	31 ft./lb.

METRIC BOLTS

Thread Size	Grade	Torque
12mm-1.25	8.8	64 ft./lb.
12mm-1.5	8.8	60 ft./lb.
12mm-1.75	8.8	55 ft./lb.
14mm-2.0	8.8	88 ft./lb.

All illustrations and specifications contained herein are based on the latest information available at the time of publication approval. ROADMASTER, INC. reserves the right to make changes at any time without notice in material, specification and models or to discontinue models.



BASEPLATE KIT INSTALLATION INSTRUCTIONS

KIT# 3160-3B

03/25/15
KS

ROADMASTER, Inc. 6110 NE 127th Ave. Vancouver, WA 98682 360-896-0407 fax 360-735-9300 www.roadmasterinc.com

Supplemental Instructions to Remove the Power Steering Cooler

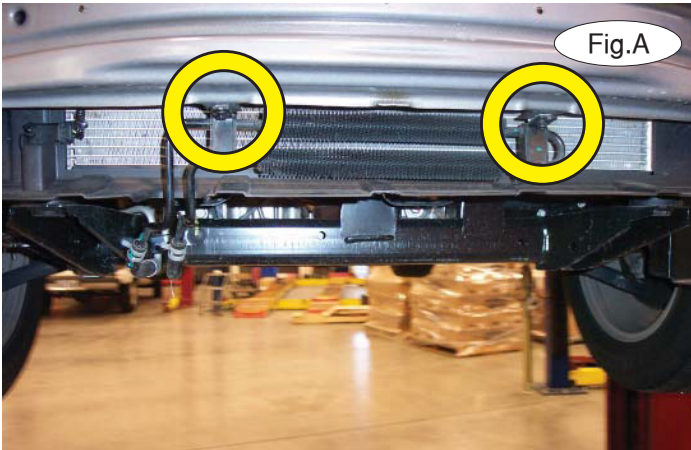

1. Remove the power steering cooler from the bumper core by removing two 10mm (head) bolts (Fig.A).
2. Now, return to the regular instructions to complete steps 6 through 19 before moving on to the next step.
3. Remove the slip nuts from the bumper core (Fig.B).

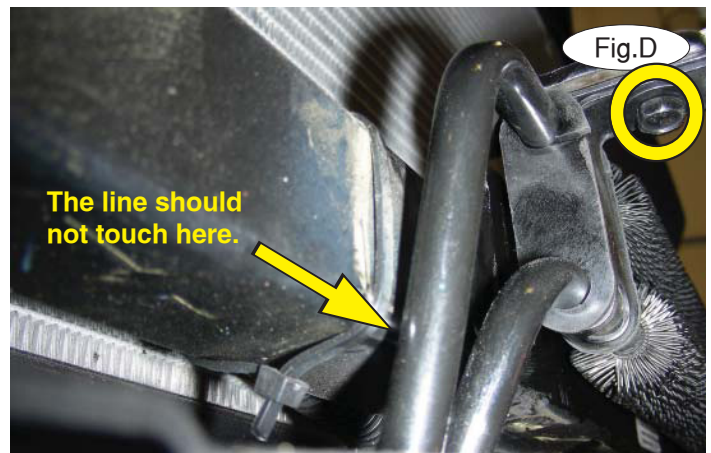

4. Place the slip nuts on the power steering cooler mounting points on the main receiver brace (Fig.C).
5. Bolt the power steering cooler to the mounts on the main receiver brace using the factory bolts you removed in step 1 in these supplemental instructions (Fig.D – passenger side bolt).
6. If the power steering cooler line on the left side is contacting the main receiver brace, bend it slightly outward (Fig.D).
7. Now, proceed to steps 20 through 23 in the regular instructions before moving on to the next step.
8. If the power steering cooler lines contact the lower half of the fascia and the backside of the grille opening, use the red lines in Figure E as a guide to trim a small amount of the fascia and the grille to allow for clearance.

