



BASEPLATE KIT INSTALLATION INSTRUCTIONS

KIT# 521424-5

04/18/16
KS

ROADMASTER, Inc. 6110 NE 127th Ave. Vancouver, WA 98682 360-896-0407 fax 360-735-9300 www.roadmasterinc.com

Important
Note: this bracket will not accommodate the Guardian rock shield, some models of the Tow Defender, or the StowMaster and StowMaster All Terrain tow bars.

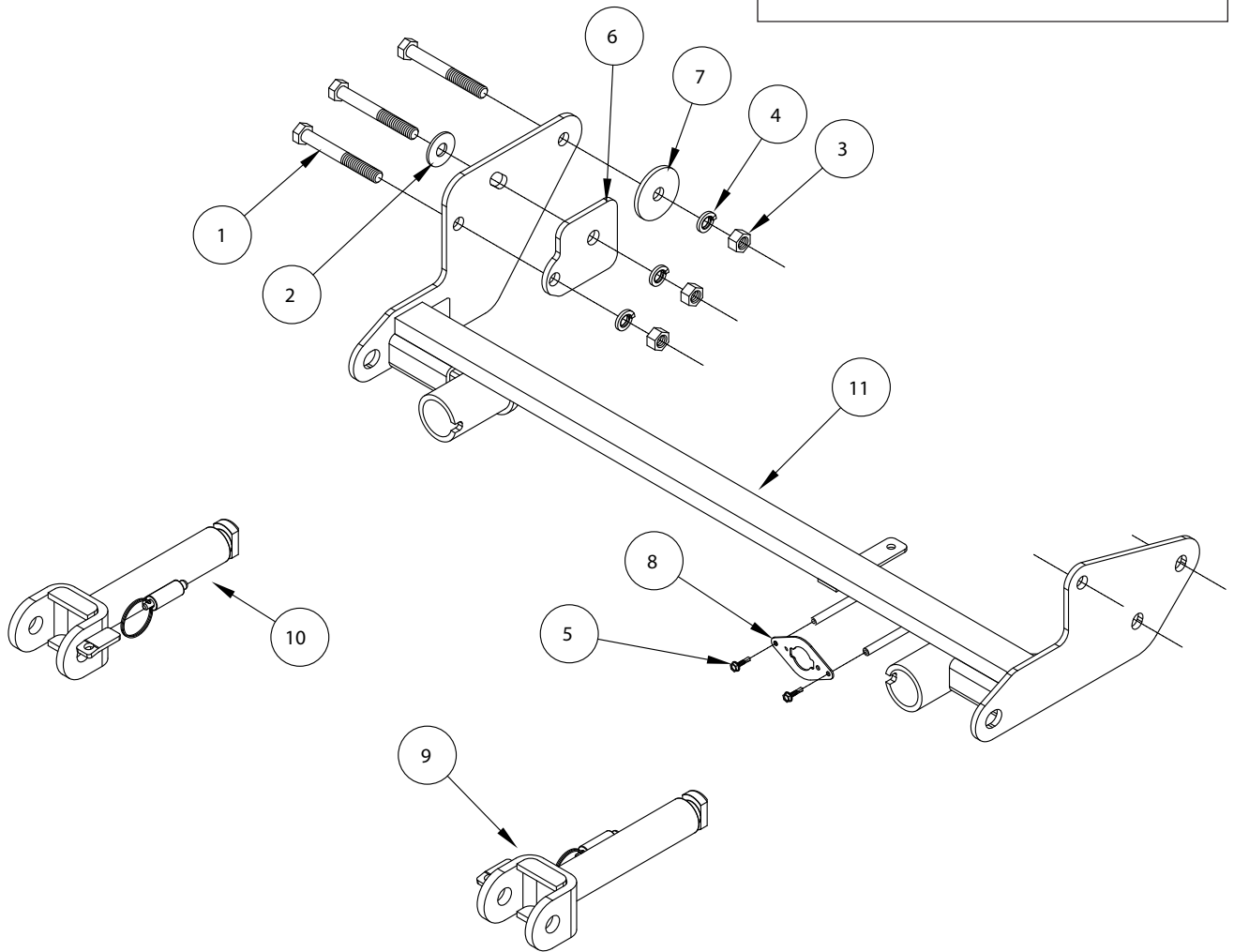

ITEM	QTY	NAME	PART #
1.....	3	1/2" x 4" BOLT	350105-00
2.....	1	1/2" FLAT WASHER	350308-00
3.....	3	1/2" NUT	350258-00
4.....	3	1/2" LOCK WASHER	350309-00
5.....	2	#10 x 3/4" SELF DRILLING SCREW	350247-35
6.....	1	PASSENGER SIDE BACKING PLATE	A-000583
7.....	1	1/2" PLATE WASHER	A-003086
8.....	1	WIRE PLUG PLATE	A-003801
9.....	1	DRIVER SIDE ARM	C-002383
10.....	1	PASSENGER SIDE ARM	C-002384
11.....	1	MAIN RECEIVER BRACE	C-003028



BASEPLATE KIT INSTALLATION INSTRUCTIONS

KIT# 521424-5

04/18/16
KS

ROADMASTER, Inc. 6110 NE 127th Ave. Vancouver, WA 98682 360-896-0407 fax 360-735-9300 www.roadmasterinc.com

This is one of our EZ5 series brackets, which allows the visible front portion of the bracket to be easily removed from the front of the vehicle (Fig.A and Fig.B). The bracket consists of a main receiver brace, two removable front braces, and a hardware pack.

The main receiver brace mounts to the frame rails. The removable front braces install in the main receiver brace.

Before starting the installation, lay out the kit components in order, as they will be used. This will give you a visual idea of how the components work, and will also confirm that everything is present and accounted for.



Fig.A



Fig.B

IMPORTANT: All baseplates **must** be assembled with all the bolts left loose for final adjustment and positioning (before tightening) unless otherwise instructed. All bolts **must** be torqued for proper strength. If more than one bolt is used per fastening point, the diagram may only show one. Use flat washers over all slotted holes and lock washers on all fasteners.

WARNING

Failure to heed these warnings or follow the installation instructions may result in a voided warranty, loss of towed vehicle, personal injury or death.

- Do not weld or modify this baseplate or its components. Welding or modification will void the warranty.
- Do not use this document as a basis to design/fabricate a baseplate, as it may not show all parts or structural components.
- We strongly recommend professional installation.
- If the towed vehicle has been in an accident, it must be properly repaired before attaching the baseplate. Do not install the baseplate if any structural frame damage is found.
- The installer must use all bolts and parts supplied. If running changes were made by the vehicle manufacturer after this kit was designed, some bolts or other fasteners may no longer be the correct size. It is the installer's responsibility to verify this kit is securely fastened to the vehicle.
- Use Loctite® Red on all bolts used to secure this baseplate. Torque all bolts to the specifications found at the end of these instructions. Do not over-torque the bolts or failure may occur.
- The installer must inspect the baseplate to ensure adequate clearance, particularly around hoses, air conditioner lines, radiators, etc. or non-warranty failure may result.
- Roadmaster manufactures many styles of baseplates. If your baseplate has removable arms, they must be removed before driving the vehicle, unless the arms can be pinned or padlocked in place. If not secured, the arms could vibrate out.
- Some motorhome chassis have such a tight turning radius that you can damage your motorhome, towed vehicle, tow bar or baseplate while turning sharply. Before getting on the road, test your turning radius in an empty parking lot. Turning too sharply could result in non-warranty damage to your towing system, motorhome and/or towed vehicle.
- Do not back up with the towed vehicle attached or non-warranty damage will occur to your towing system or vehicles.
- The safety cables must connect the towing vehicle to the towed vehicle frame to frame, with the cables crossed, with enough slack for sharp turns. See cable instructions for proper routing. Failure to do so will result in non-warranty damage and/or the loss of the towed vehicle.
- This kit is designed for use with ROADMASTER tow bars and ROADMASTER adapters only. Using this kit with other brands, without an approved ROADMASTER adapter, may result in non-warranty damage or injury.
- Receiver extensions and out-of-level towing situations of 3 inches or more. This can cause the system to swing much higher and lower, causing excessive strain on the tow bar, baseplate and frame. That can cause the towing system to fail, causing property damage, personal injury or even death. If you must use a receiver extension or drop hitch to tow, it will reduce your receiver's weight capacity by 1/3 to avoid damaging your system. Never use more than one extension and/or drop hitch, as this will void your warranty.
- Every 3,000 miles, the owner must inspect all mounting points for cracks or fatigue, and check the fasteners for proper torque, according to the bolt torque requirements chart on the last page of these instructions.
- The owner must follow the vehicle manufacturer's instructions to prepare the vehicle for towing. Failure to do so may cause severe damage to the vehicle.
- This baseplate is only warranted for the original installation. Installing a used baseplate on another vehicle is not recommended and will void the warranty.



BASEPLATE KIT INSTALLATION INSTRUCTIONS

KIT# 521424-5

04/18/16
KS

ROADMASTER, Inc. 6110 NE 127th Ave. Vancouver, WA 98682 360-896-0407 fax 360-735-9300 www.roadmasterinc.com



1. **Important:** please use all supplied bolts and parts and read all instructions carefully before beginning this installation. The majority of questions you may have can be answered within the text, and proper installation will ensure safe and secure travel. On the driver's side only, remove the rear 5/8" steering box bolt from the side of the frame (Fig.C).

2. Place the main receiver brace around the frame on each side and align it with the hole you exposed in the previous step. Replace the bolt you removed in the previous step, tightening it but leaving it out about an 1/8" (Fig.D). Let the bracket hang down for now. *Note:* ensure proper alignment, as the bolts will receive Loctite® Red and will be torqued at the end of these instructions.

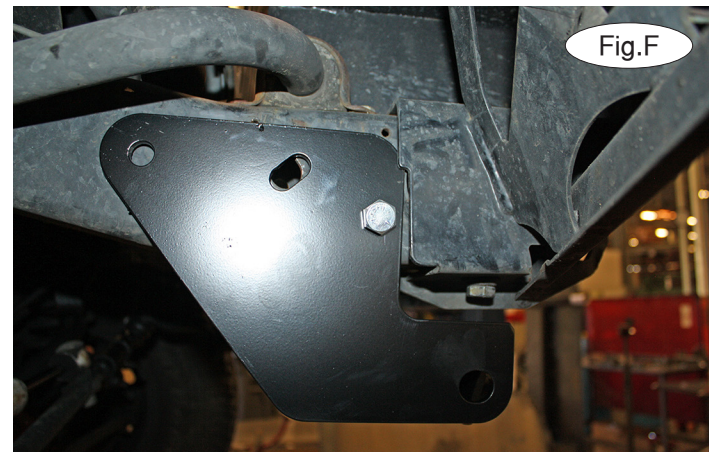
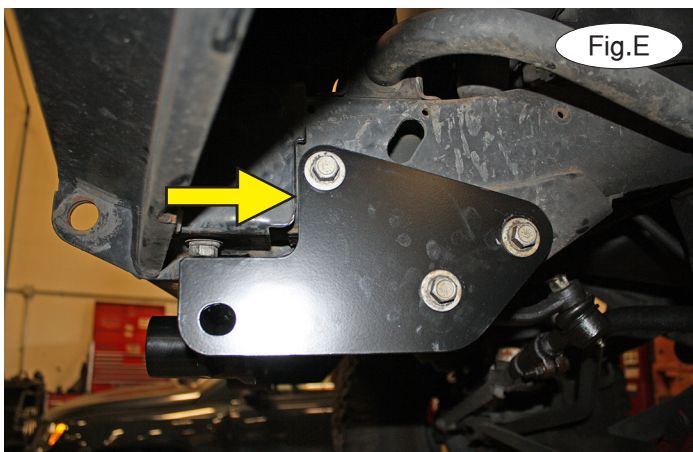

3. Using a jack stand, if necessary, to support the steering box, remove the two remaining 5/8" bolts from the steering box and rotate the bracket up over the holes and replace the bolts (Fig.E). *Note:* if the edge of your bumper (Fig.E – arrow) impedes your ability to rotate the bracket, loosen the rear bolt slightly to allow it to clear the edge.

4. On the passenger side, use the supplied 1/2" x 4" bolt in the forwardmost hole (Fig.F). Finish with the passenger side backing plate, 1/2" lock washer and 1/2" nut (Fig.G).

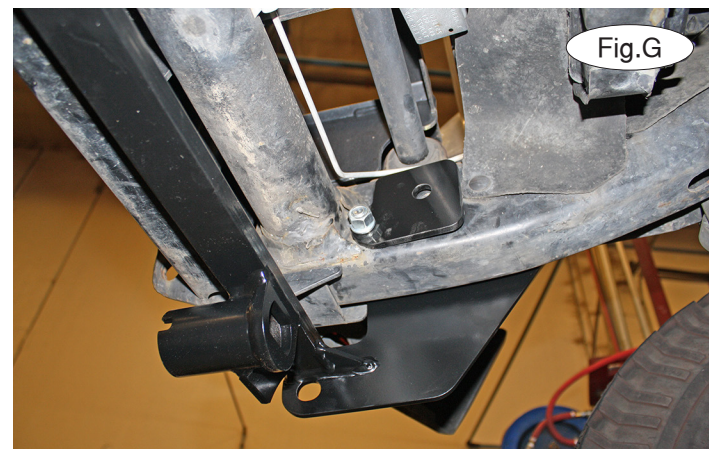



BASEPLATE KIT INSTALLATION INSTRUCTIONS

KIT# 521424-5

04/18/16
KS

ROADMASTER, Inc. 6110 NE 127th Ave. Vancouver, WA 98682 360-896-0407 fax 360-735-9300 www.roadmasterinc.com



5. Ensure that the bracket is level side to side (Fig.H) and front to back (Fig.I). Then, tighten all bolts to the bolt torque specifications found at the end of these instructions. *Note:* use Loctite® Red on all nuts and bolts. Ensure that the backing plate is still level before proceeding to the next step.

6. On each side, drill a ½" hole straight through the center of the slotted hole, ensuring that the drill is level (Fig.J). Drill through the inside layer of the frame and out through the backing plate you installed in step 4. Then, place a ½" plate washer over a ½" x 4" bolt and bolt through the bracket, backing plate and frame rail and finish with a ½" nut (Fig.K).



7. On each side, use the rearmost hole in the bracket as a template and drill straight through both layers of the frame. Then, bolt through the hole using the supplied ½" x 4" bolt and finish with a ½" plate washer, lock washer and nut on the inside of the frame rail, lifting the rubber covering out of the way to allow for clearance (Fig.L).

8. Tighten all bolts to the bolt torque requirements found at the end of these instructions. *Note:* use Loctite® Red on all nuts and bolts.





BASEPLATE KIT INSTALLATION INSTRUCTIONS

KIT# 521424-5

04/18/16
KS

ROADMASTER, Inc. 6110 NE 127th Ave. Vancouver, WA 98682 360-896-0407 fax 360-735-9300 www.roadmasterinc.com



9. **Note: the following four images are for illustration purposes only, as your specific application may be slightly different.**

The spring-loaded pin on the removable arm snaps into a notch on the receiver, locking the removable arm into its final towing position. Before inserting each arm into the receiver, verify that the spring is working by ensuring that the spring-loaded pin moves easily back and forth within the barrel when pulled and that it can be pulled flush with the face of the barrel (Fig.M and Fig.N).

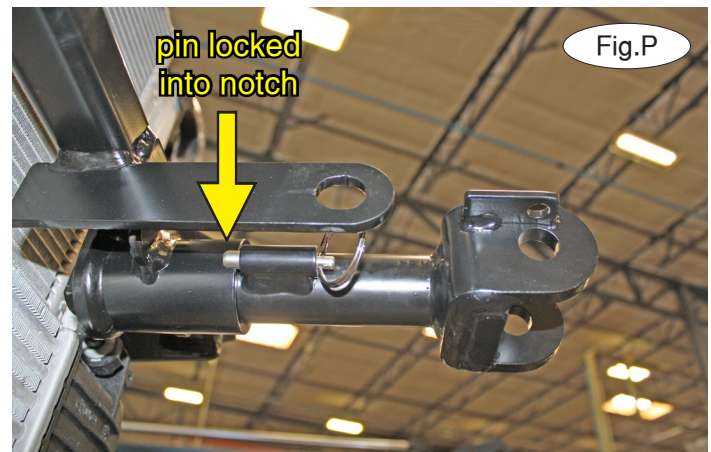
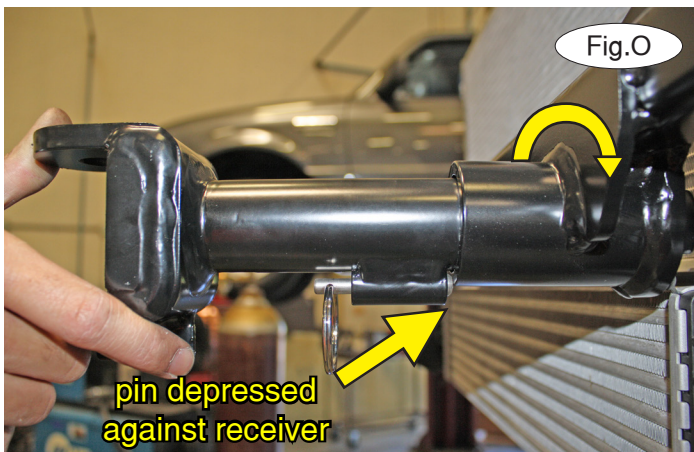

10. On each side, insert the removable front bracket arm into the front receiver 90 degrees from its final towing position, depressing the spring-loaded pin against the receiver (Fig.O). Now, twist back 90 degrees until the spring-loaded pin snaps into place in the notch on the receiver, locking the arm into place in its final towing position (Fig.P).

Please note: it is the owner's responsibility to ensure the locking of the pins before towing. Otherwise, failure of the towing system will result.

11. Install the tow bar to the mounting bracket according to the manufacturer's instructions.



BASEPLATE KIT INSTALLATION INSTRUCTIONS

KIT# 521424-5

04/18/16
KS

ROADMASTER, Inc. 6110 NE 127th Ave. Vancouver, WA 98682 360-896-0407 fax 360-735-9300 www.roadmasterinc.com

IMPORTANT!

Safety cables are required by law. When towing, connect safety cables to the safety cable tabs illustrated in Figure Q. Make certain there is adequate slack in the cables to allow a full turning radius; otherwise, damage will result. If necessary, longer cables or cable extensions are available.

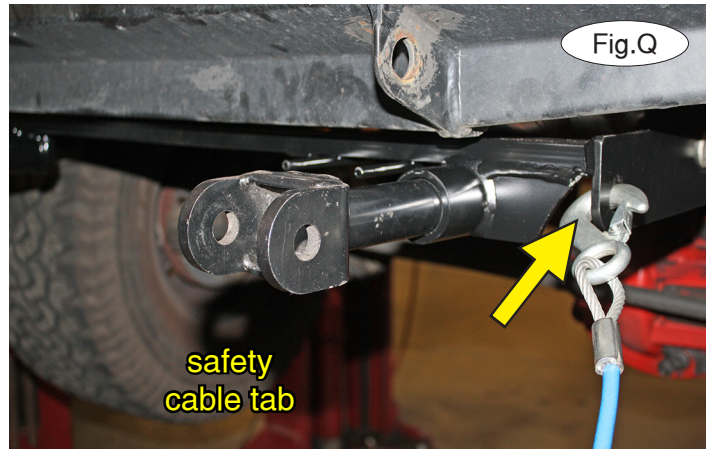

Three options for attaching the wiring plug to the main receiver brace

For six-wire plugs: use the two supplied 3/4" self-tapping screws to attach the electrical plug directly to the rods on the front of the main receiver brace.

For four-wire round plugs: attach to the plug mounting plate and then use the two supplied 3/4" self-tapping screws to attach the mounting plate to the rods on the front of the main receiver brace.

For four-wire flat plugs: place the plug through the mounting plug plate, and then secure it using the supplied zip tie on the front of the plug (Fig.R). Use the two supplied 3/4" self-tapping screws to attach the mounting plate to the rods on the front of the main receiver brace.

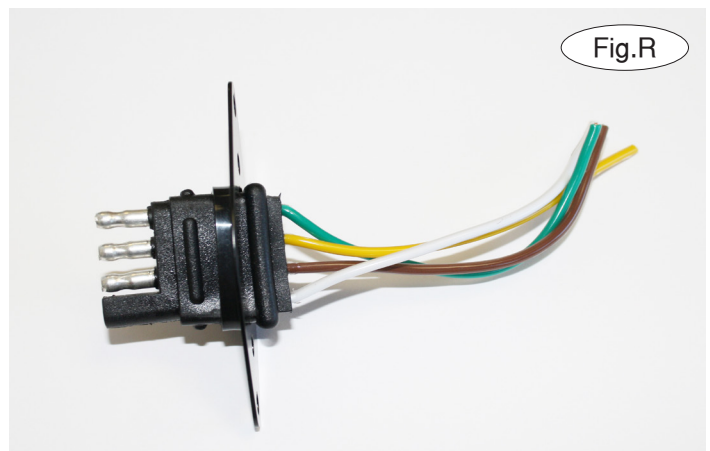

BOLT TORQUE REQUIREMENTS

Note: The torque values represented below are intended as general guidelines. Torque requirements for specific applications may vary. Roadmaster does not warrant this information to be accurate for all applications and disclaims all liability for any claims or damages which may result from its use.

STANDARD BOLTS

Thread Size	Grade	Torque
5/16-18	5	13 ft./lb.
3/8-16	5	23 ft./lb.
7/16-14	5	37 ft./lb.
1/2-13	5	57 ft./lb.
5/8-11	5	112 ft./lb.

METRIC BOLTS

Thread Size	Grade	Torque
6mm-1.0	8.8	6 ft./lb.
8mm-1.0	8.8	18 ft./lb.
8mm-1.25	8.8	16 ft./lb.
10mm-1.25	8.8	36 ft./lb.
10mm-1.5	8.8	31 ft./lb.

METRIC BOLTS

Thread Size	Grade	Torque
12mm-1.25	8.8	64 ft./lb.
12mm-1.5	8.8	60 ft./lb.
12mm-1.75	8.8	55 ft./lb.
14mm-2.0	8.8	88 ft./lb.

All illustrations and specifications contained herein are based on the latest information available at the time of publication approval. ROADMASTER, INC. reserves the right to make changes at any time without notice in material, specification and models or to discontinue models.