



BASEPLATE KIT INSTALLATION INSTRUCTIONS

KIT# 521450-4

02/11/19
KS

ROADMASTER, Inc. 6110 NE 127th Ave. Vancouver, WA 98682 360-896-0407 fax 360-735-9300 www.roadmasterinc.com

Special Tools Needed
Die Grinder, Cut-off Wheel or
Reciprocating Saw

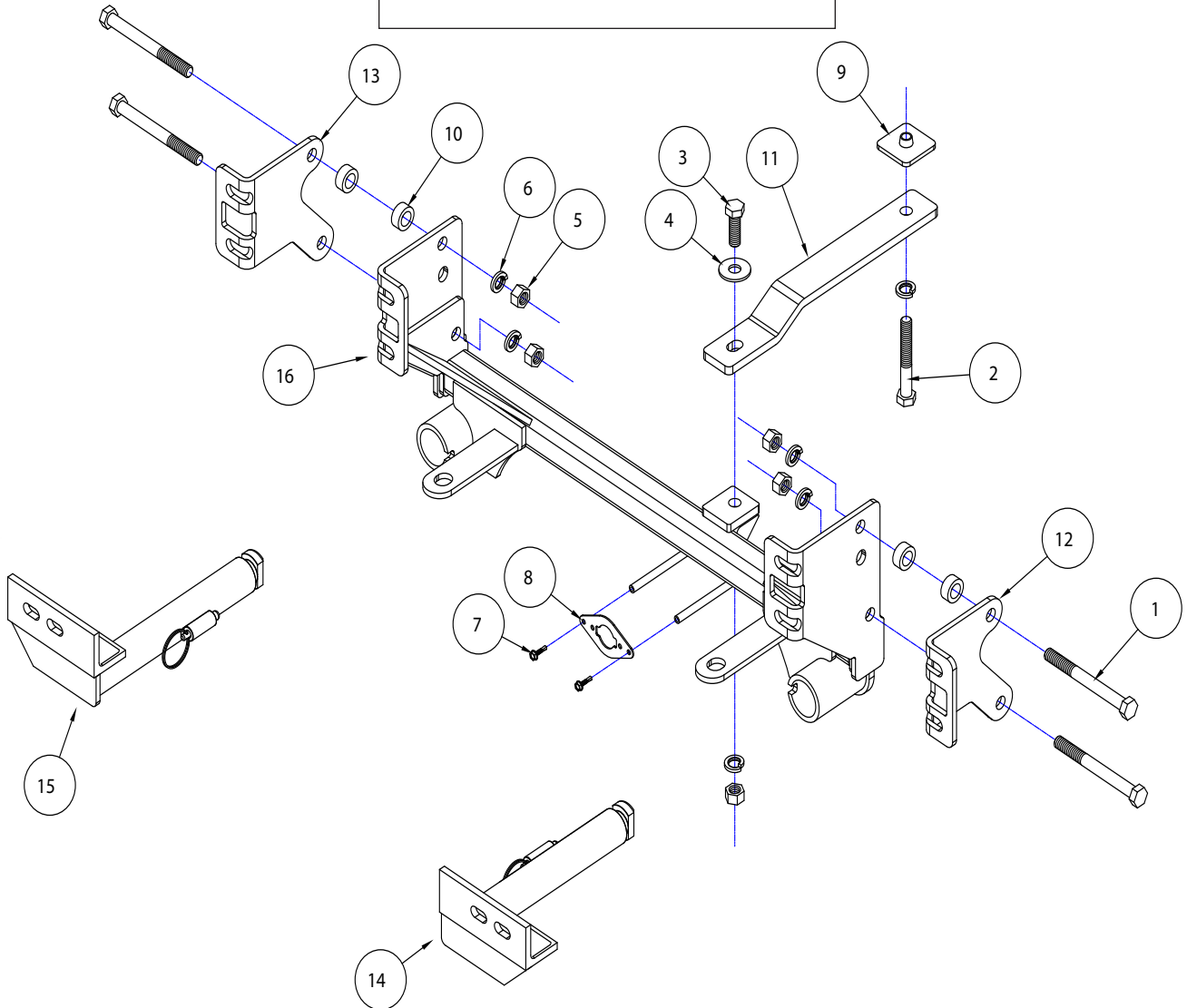

ITEM	QTY	NAME	PART #
1	4	1/2" x 5" BOLT	350107-00
2	1	1/2" x 3 1/2" BOLT	350103-00
3	1	1/2" x 1 1/2" BOLT	350095-00
4	1	1/2" FLAT WASHER	350308-00
5	5	1/2" NUT	350258-00
6	6	1/2" LOCK WASHER	350309-00
7	2	#10 x 3/4" SELF DRILLING SCREW	350247-35
8	1	WIRE PLUG PLATE	A-003801
9	1	3/16" x 2" x 2" THREADED BACKING PLATE	A-003080
10	4	1" O.D. x 0.188 WALL TUBE SPACER x 7/16"	A-005858
11	1	REAR MOUNTING PLATE	B-003523
12	1	DRIVER SIDE SIDE MOUNTING PLATE	B-003524
13	1	PASSENGER SIDE SIDE MOUNTING PLATE	B-003525
14	1	DRIVER SIDE ARM	C-003277
15	1	PASSENGER SIDE ARM	C-003278
16	1	MAIN RECEIVER	C-003279

ROADMASTER, INC.



BASEPLATE KIT INSTALLATION INSTRUCTIONS

KIT# 521450-4

02/11/19
KS

ROADMASTER, Inc. 6110 NE 127th Ave. Vancouver, WA 98682 360-896-0407 fax 360-735-9300 www.roadmasterinc.com

This is one of our crossbar-style series, which allows the visible front portion of the baseplate to be easily removed from the front of the vehicle (Fig.A and Fig.B). This kit consists of a main receiver brace, two rear braces, a crossmember brace, two removable front braces, and a hardware pack.

The main receiver brace mounts to the frame, the rear braces and the crossmember. The removable front braces install in the main receiver brace.

Before starting the installation, lay out the kit components in order, as they will be used. This will give you a visual idea of how the components work, and will also confirm that everything is present and accounted for.



IMPORTANT: All baseplates **must** be assembled with all the bolts left loose for final adjustment and positioning (before tightening) unless otherwise instructed. All bolts **must** be torqued for proper strength. If more than one bolt is used per fastening point, the diagram may only show one. Use flat washers over all slotted holes and lock washers on all fasteners.

WARNING

Failure to heed these warnings or follow the installation instructions may result in a voided warranty, loss of towed vehicle, personal injury or death.

- Do not weld or modify this baseplate or its components. Welding or modification will void the warranty.
- Do not use this document as a basis to design/fabricate a baseplate, as it may not show all parts or structural components.
- We strongly recommend professional installation.
- If the towed vehicle has been in an accident, it must be properly repaired before attaching the baseplate. Do not install the baseplate if any structural frame damage is found.
- The installer must use all bolts and parts supplied. If running changes were made by the vehicle manufacturer after this kit was designed, some bolts or other fasteners may no longer be the correct size. It is the installer's responsibility to verify this kit is securely fastened to the vehicle.
- Use Loctite® Red on all bolts used to secure this baseplate. Torque all bolts to the specifications found at the end of these instructions. Do not over-torque the bolts or failure may occur.
- The installer must inspect the baseplate to ensure adequate clearance, particularly around hoses, air conditioner lines, radiators, etc. or non-warranty failure may result.
- Roadmaster manufactures many styles of baseplates. If your baseplate has removable arms, they must be removed before driving the vehicle, unless the arms can be pinned or padlocked in place. If not secured, the arms could vibrate out.
- Some motorhome chassis have such a tight turning radius that you can damage your motorhome, towed vehicle, tow bar or baseplate while turning sharply. Before getting on the road, test your turning radius in an empty parking lot. Turning too sharply could result in non-warranty damage to your towing system, motorhome and/or towed vehicle.
- Do not back up with the towed vehicle attached or non-warranty damage will occur to your towing system or vehicles.
- The safety cables must connect the towing vehicle to the towed vehicle frame to frame, with the cables crossed, with enough slack for sharp turns. See cable instructions for proper routing. Failure to do so will result in non-warranty damage and/or the loss of the towed vehicle.
- This kit is designed for use with ROADMASTER tow bars and ROADMASTER adapters only. Using this kit with other brands, without an approved ROADMASTER adapter, may result in non-warranty damage or injury.
- Receiver extensions and out-of-level towing situations of 3 inches or more. This can cause the system to swing much higher and lower, causing excessive strain on the tow bar, baseplate and frame. That can cause the towing system to fail, causing property damage, personal injury or even death. If you must use a receiver extension or drop hitch to tow, it will reduce your receiver's weight capacity by 1/3 to avoid damaging your system. Never use more than one extension and/or drop hitch, as this will void your warranty.
- Every 3,000 miles, the owner must inspect all mounting points for cracks or fatigue, and check the fasteners for proper torque, according to the bolt torque requirements chart on the last page of these instructions.
- The owner must follow the vehicle manufacturer's instructions to prepare the vehicle for towing. Failure to do so may cause severe damage to the vehicle.
- This baseplate is only warranted for the original installation. Installing a used baseplate on another vehicle is not recommended and will void the warranty.



BASEPLATE KIT INSTALLATION INSTRUCTIONS

KIT# 521450-4

02/11/19
KS

ROADMASTER, Inc. 6110 NE 127th Ave. Vancouver, WA 98682 360-896-0407 fax 360-735-9300 www.roadmasterinc.com

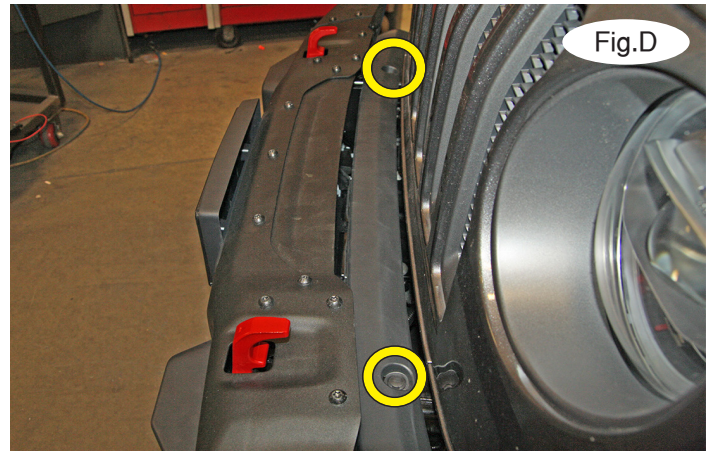
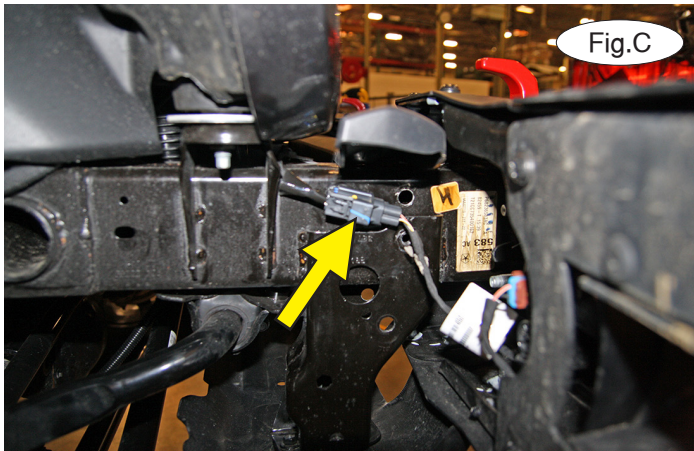

1. **Important:** please use all supplied bolts and parts and read all instructions carefully before beginning this installation. The majority of questions you may have can be answered within the text, and proper installation will ensure safe and secure travel. Begin the installation by disconnecting the fog lights on the passenger side, if the vehicle is so equipped (Fig.C). **For Sahara, Sport and Sport S models only:** Proceed now to the fascia removal supplement at the end of these instructions. **For Rubicon models only:** Proceed to step 2.

2. Remove two plastic fasteners attaching the drip rail to the frame (Fig.D) and set it aside for now.

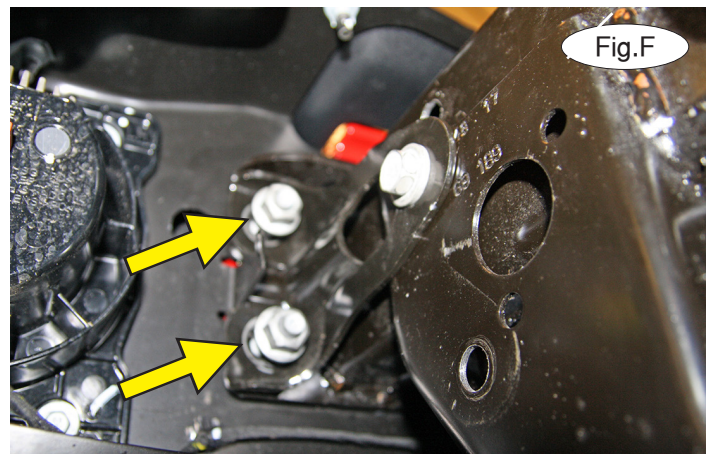
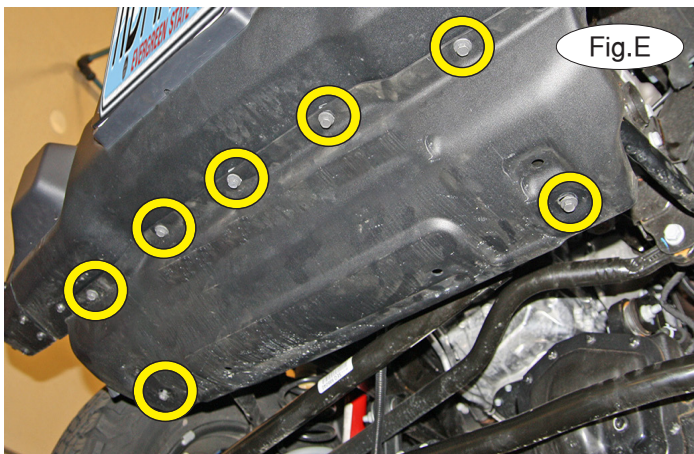

3. Remove seven 13mm (head) bolts attaching the rock guard to the bumper and frame (Fig.E).

4. On each side, remove four 18mm (head) nuts attaching the bumper to the frame (Fig.F – only two nuts shown). Pull out firmly to remove the bumper and set it aside for now.

5. On each side, remove two 16mm (head) bolts attaching the frame stiffeners to the frame (Fig.G). The stiffeners will not be replaced. *Note:* retain the frame stiffeners for replacement in case the baseplate is ever removed.

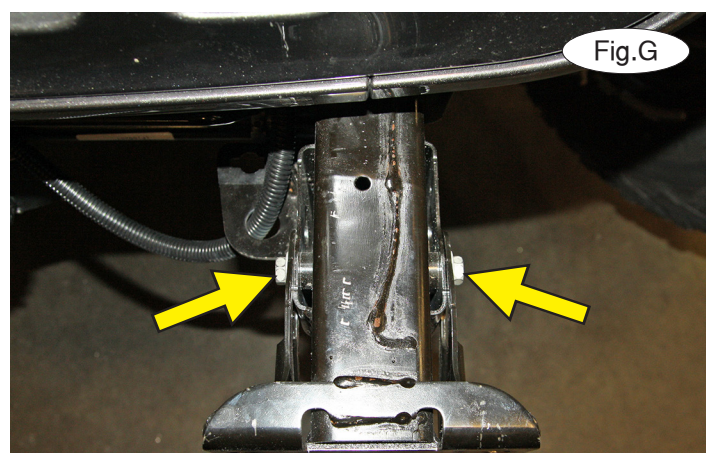



BASEPLATE KIT INSTALLATION INSTRUCTIONS

KIT# 521450-4

02/11/19
KS

ROADMASTER, Inc. 6110 NE 127th Ave. Vancouver, WA 98682 360-896-0407 fax 360-735-9300 www.roadmasterinc.com

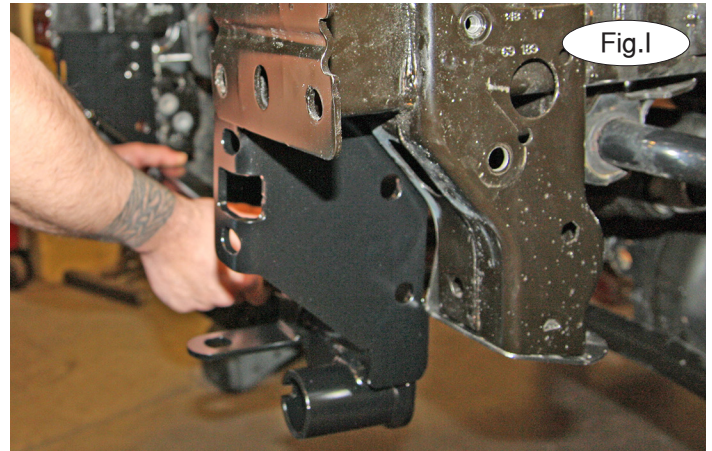
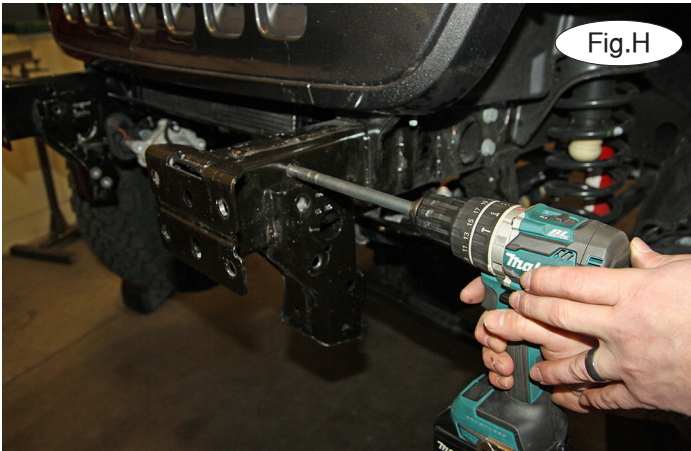

6. On each side, locate two holes above and below the bolts you removed in the previous step. Then, use a ½" drill bit to enlarge the holes. Drill through both the outside and inside of the frame (Fig.H).

7. Slide the main receiver brace up and to the inside of the frame rails (Fig.I) and use a jack stand to hold it in place (Fig.J).

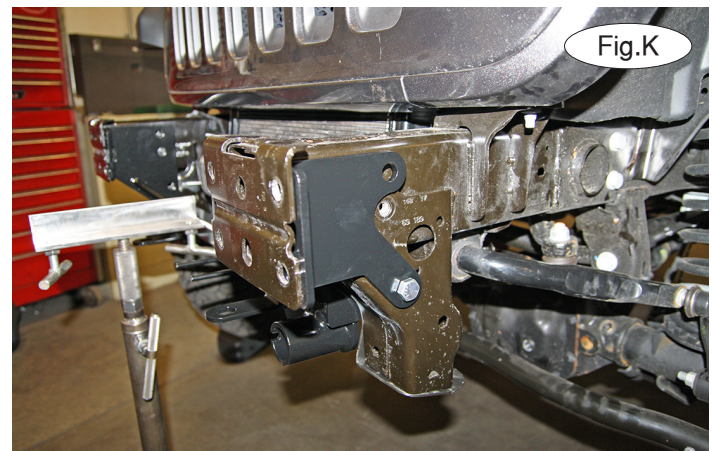

8. Using the drawing on page 1 as a reference, locate the side-specific rear braces. On each side, install them by aligning the holes in the main receiver brace with the holes you enlarged in step 6 and then bolt through the bottom hole using the supplied ½" x 5" bolts. Finish with a ½" lock washer and nut (Fig.K).

9. On each side, place two 7/16" pipe spacers between the brace and the frame rail (Fig.L – arrows). Then, bolt through the rear brace, pipe spacer, frame rail, pipe spacer, and the main receiver brace using the supplied ½" x 5" bolt. Finish with a ½" lock washer and nut (Fig.L).

IMPORTANT Leave all of the bolts loose for now.

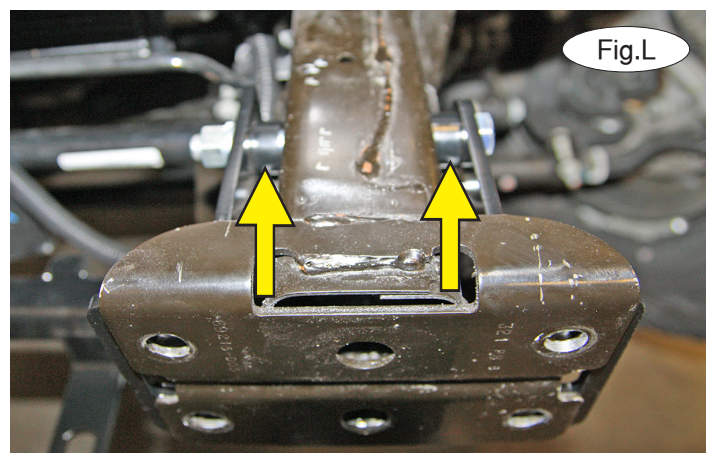



BASEPLATE KIT INSTALLATION INSTRUCTIONS

KIT# 521450-4

02/11/19
KS

ROADMASTER, Inc. 6110 NE 127th Ave. Vancouver, WA 98682 360-896-0407 fax 360-735-9300 www.roadmasterinc.com

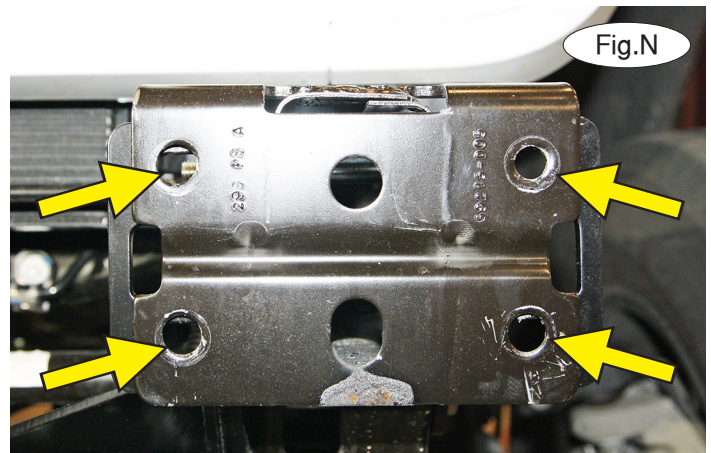
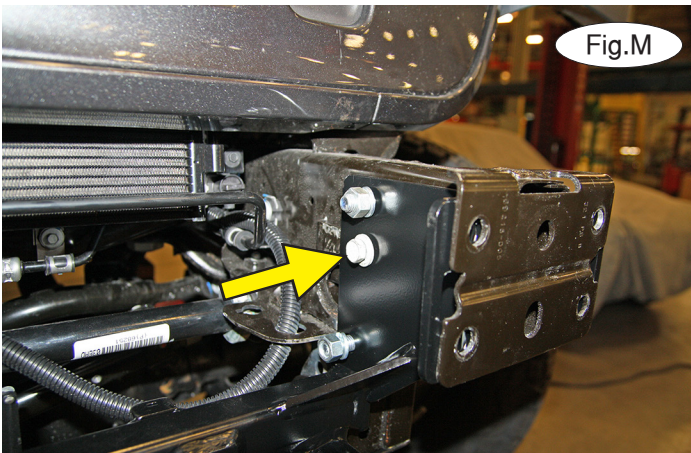

10. On each side, replace the frame stiffener bolts from step 5. Bolt from the inside of the frame to the outside (Fig.M).
11. Ensure that the front mounting holes are aligned before proceeding to the next step (Fig.N).

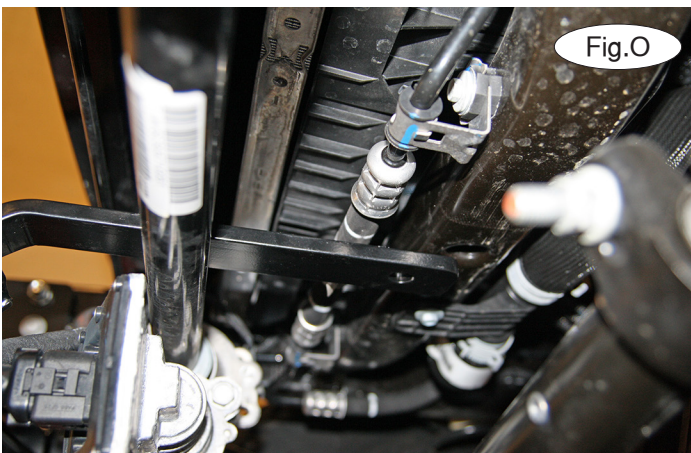

12. Locate the crossmember support brace and place it over the main receiver brace and (Fig.O) and over the swaybar. Then, bolt down the crossmember and into the main receiver mount using the supplied $\frac{1}{2}$ " x $1\frac{1}{2}$ " bolt and $\frac{1}{2}$ " washer and finish with a $\frac{1}{2}$ " lock washer and nut (Fig.P). On the rear mount of the crossmember, place a $\frac{3}{16}$ " x 2" x 2" nutted backing plate on top and then bolt up through the mount, the crossmember, and into the nutted backing plate using the supplied $\frac{1}{2}$ " x $3\frac{1}{2}$ " bolt and $\frac{1}{2}$ " lock washer (Fig.Q).





BASEPLATE KIT INSTALLATION INSTRUCTIONS

KIT# 521450-4

02/11/19
KS

ROADMASTER, Inc. 6110 NE 127th Ave. Vancouver, WA 98682 360-896-0407 fax 360-735-9300 www.roadmasterinc.com



13. Reinstall the bumper by reversing step 4 and tighten the bolts you installed in steps 8-10 and 12. Reinstall the drip rail by reversing steps 1 and 2 and then, trim the metal rock guard as shown in Figure R to allow clearance for the main receiver brace. Plastic rock guards can be trimmed as shown in Figures S, T (passenger side) and U (driver's side) to allow just enough room for the receivers, safety cable tabs and wiring plug rods. Then, reinstall the rock guard.



14. **Note: the images in this step are for illustration purposes only, as your specific application may be slightly different.** On each side, insert the removable front bracket arm into the front receiver 90 degrees from its final towing position, depressing the spring-loaded pin against the receiver (Fig.V). Now, twist back 90 degrees until the spring-loaded pin snaps into place in the notch on the receiver, locking the arm into place in its final towing position (Fig.W).

Please note: it is the owner's responsibility to ensure the locking of the pins before towing. Otherwise, failure of the towing system will result.

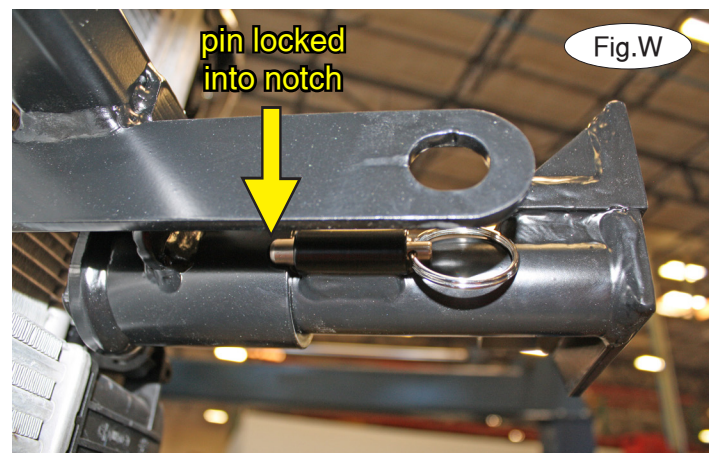
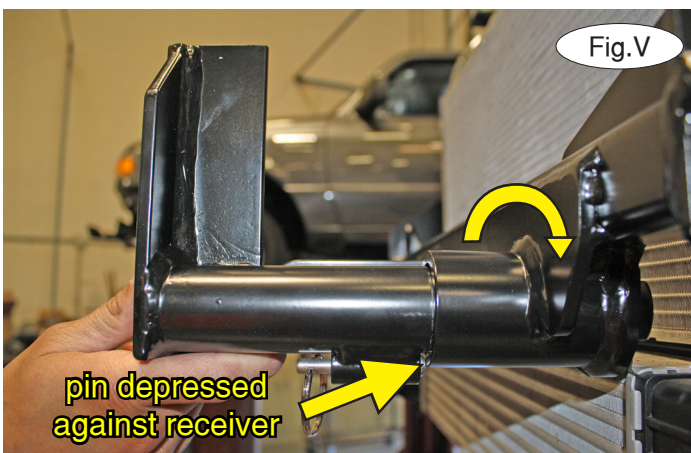



BASEPLATE KIT INSTALLATION INSTRUCTIONS

KIT# 521450-4

02/11/19
KS

ROADMASTER, Inc. 6110 NE 127th Ave. Vancouver, WA 98682 360-896-0407 fax 360-735-9300 www.roadmasterinc.com

15. Install the tow bar to the mounting bracket according to the manufacturer's instructions.

IMPORTANT!

Safety cables are required by law. When towing, connect safety cables to the safety cable tab shown in Figure X. Make certain there is adequate slack in the cables to allow a full turning radius; otherwise, damage will result. If necessary, longer cables or cable extensions are available.

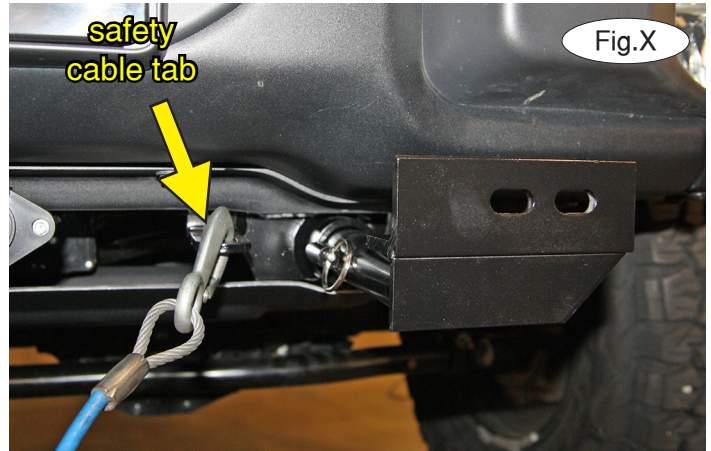

Fig.X

Three options for attaching the wiring plug to the main receiver brace

For six-wire plugs: use the two supplied 3/4" self-tapping screws to attach the electrical plug directly to the rods on the front of the main receiver brace.

For four-wire round plugs: attach to the plug mounting plate and then use the two supplied 3/4" self-tapping screws to attach the mounting plate to the rods on the front of the main receiver brace.

For four-wire flat plugs: place the plug through the mounting plug plate, and then secure it using the supplied zip tie on the front of the plug (Fig.Y). Use the two supplied 3/4" self-tapping screws to attach the mounting plate to the rods on the front of the main receiver brace.

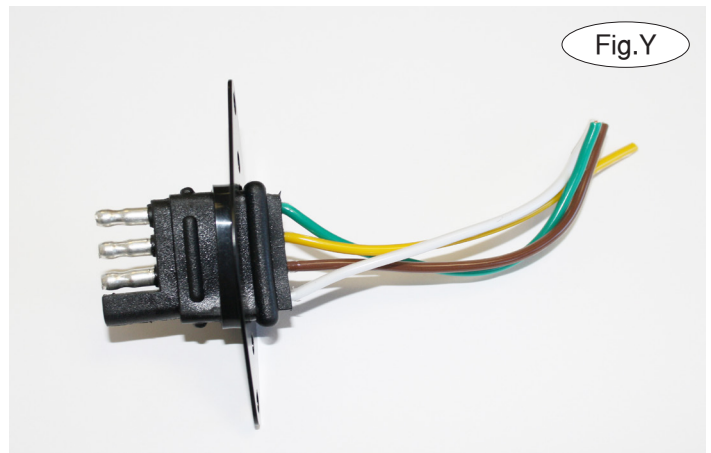

Fig.Y

BOLT TORQUE REQUIREMENTS

Note: The torque values represented below are intended as general guidelines. Torque requirements for specific applications may vary. Roadmaster does not warrant this information to be accurate for all applications and disclaims all liability for any claims or damages which may result from its use.

STANDARD BOLTS

Thread Size	Grade	Torque
5/16-18	5	13 ft./lb.
3/8-16	5	23 ft./lb.
7/16-14	5	37 ft./lb.
1/2-13	5	57 ft./lb.
5/8-11	5	112 ft./lb.

METRIC BOLTS

Thread Size	Grade	Torque
6mm-1.0	8.8	6 ft./lb.
8mm-1.0	8.8	18 ft./lb.
8mm-1.25	8.8	16 ft./lb.
10mm-1.25	8.8	36 ft./lb.
10mm-1.5	8.8	31 ft./lb.

METRIC BOLTS

Thread Size	Grade	Torque
12mm-1.25	8.8	64 ft./lb.
12mm-1.5	8.8	60 ft./lb.
12mm-1.75	8.8	55 ft./lb.
14mm-2.0	8.8	88 ft./lb.

All illustrations and specifications contained herein are based on the latest information available at the time of publication approval. ROADMASTER, INC. reserves the right to make changes at any time without notice in material, specification and models or to discontinue models.



BASEPLATE KIT INSTALLATION INSTRUCTIONS

KIT# 521450-4

02/11/19
KS

ROADMASTER, Inc. 6110 NE 127th Ave. Vancouver, WA 98682 360-896-0407 fax 360-735-9300 www.roadmasterinc.com

Supplement for Sahara, Sport and Sport S models

This is one of our crossbar-style series, which allows the visible front portion of the baseplate to be easily removed from the front of the vehicle (Fig.A and Fig.B – Sahara model pictured). This kit consists of a main receiver brace, two rear braces, a crossmember brace, two removable front braces, and a hardware pack.

The main receiver brace mounts to the frame, the rear braces and the crossmember. The removable front braces install in the main receiver brace.

Before starting the installation, lay out the kit components in order, as they will be used. This will give you a visual idea of how the components work, and will also confirm that everything is present and accounted for.



Fig.A



Fig.B

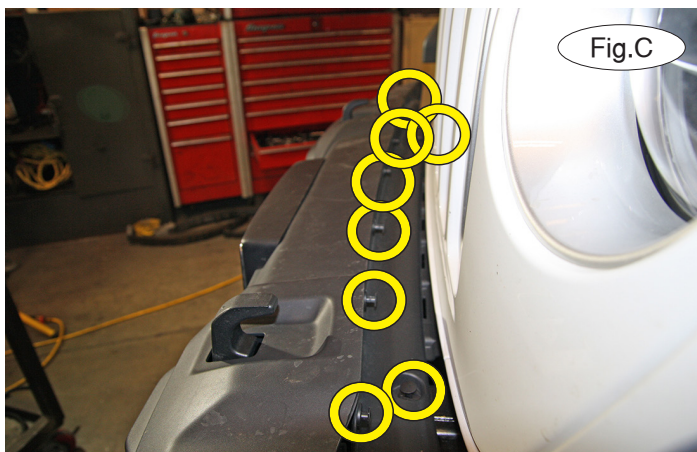

Fig.C



Fig.D

1. Remove eight plastic fasteners attaching the drip rail to the bumper (Fig.C). Push back and up to remove the drip rail.

2. Remove two 8mm (head) screws attaching the rock guard to the subframe (Fig.D).

3. On each side, remove four plastic fasteners attaching the rock guard to the lower bumper (Fig.E).

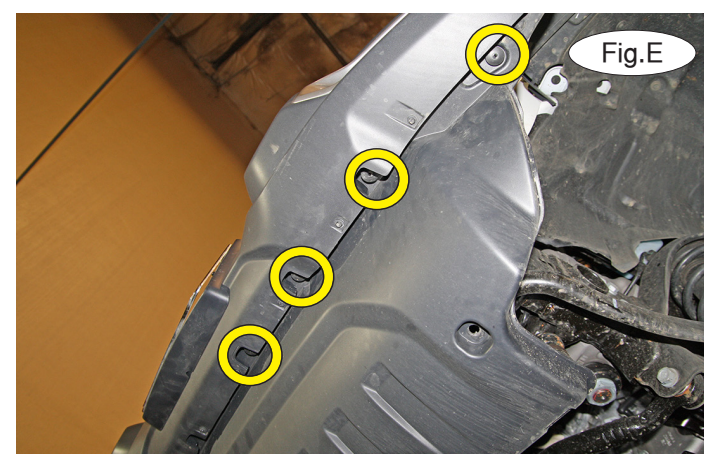

Fig.E



BASEPLATE KIT INSTALLATION INSTRUCTIONS

KIT# 521450-4

02/11/19
KS

ROADMASTER, Inc. 6110 NE 127th Ave. Vancouver, WA 98682 360-896-0407 fax 360-735-9300 www.roadmasterinc.com

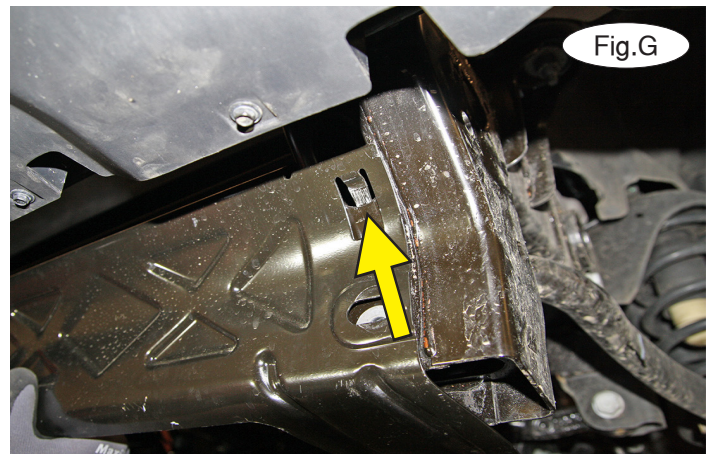

4. Remove two 16mm (head) bolts attaching the frame guard to the frame (Fig.F). Push up to release the frame guard retaining clips (Fig.G).

5. Trim the frame guard as shown (Fig.H) and then reinstall each remaining piece by replacing the 16mm (head) bolts you removed in the previous step (Fig.I).

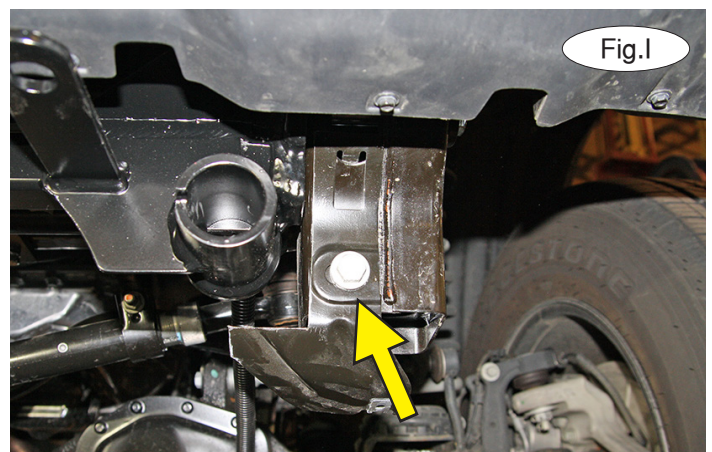
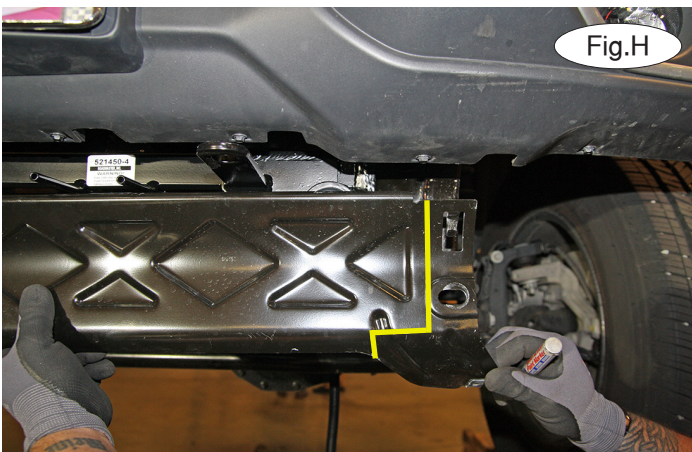

6. On each side, remove four 18mm (head) nuts attaching the bumper to the frame (Fig.J – only two nuts shown). Pull out firmly to remove the bumper and set it aside for now.

7. Turn the bumper over and place it on a secure surface. On each side, measure over 5" from the indent in the metal indicated in Figure K (arrow – passenger side). Then, use a die grinder or a reciprocating saw to trim a 1½" x 1½" hole to allow clearance for the main receiver brace.

Now, return to step 5 in the regular instructions to finish installing the baseplate

