



BASEPLATE KIT INSTALLATION INSTRUCTIONS

KIT# 521451-4

01/03/23
KS

ROADMASTER, Inc. 6110 NE 127th Ave. Vancouver, WA 98682 360-896-0407 fax 360-735-9300 www.roadmasterinc.com

Special tools needed:
plastic pop rivet gun

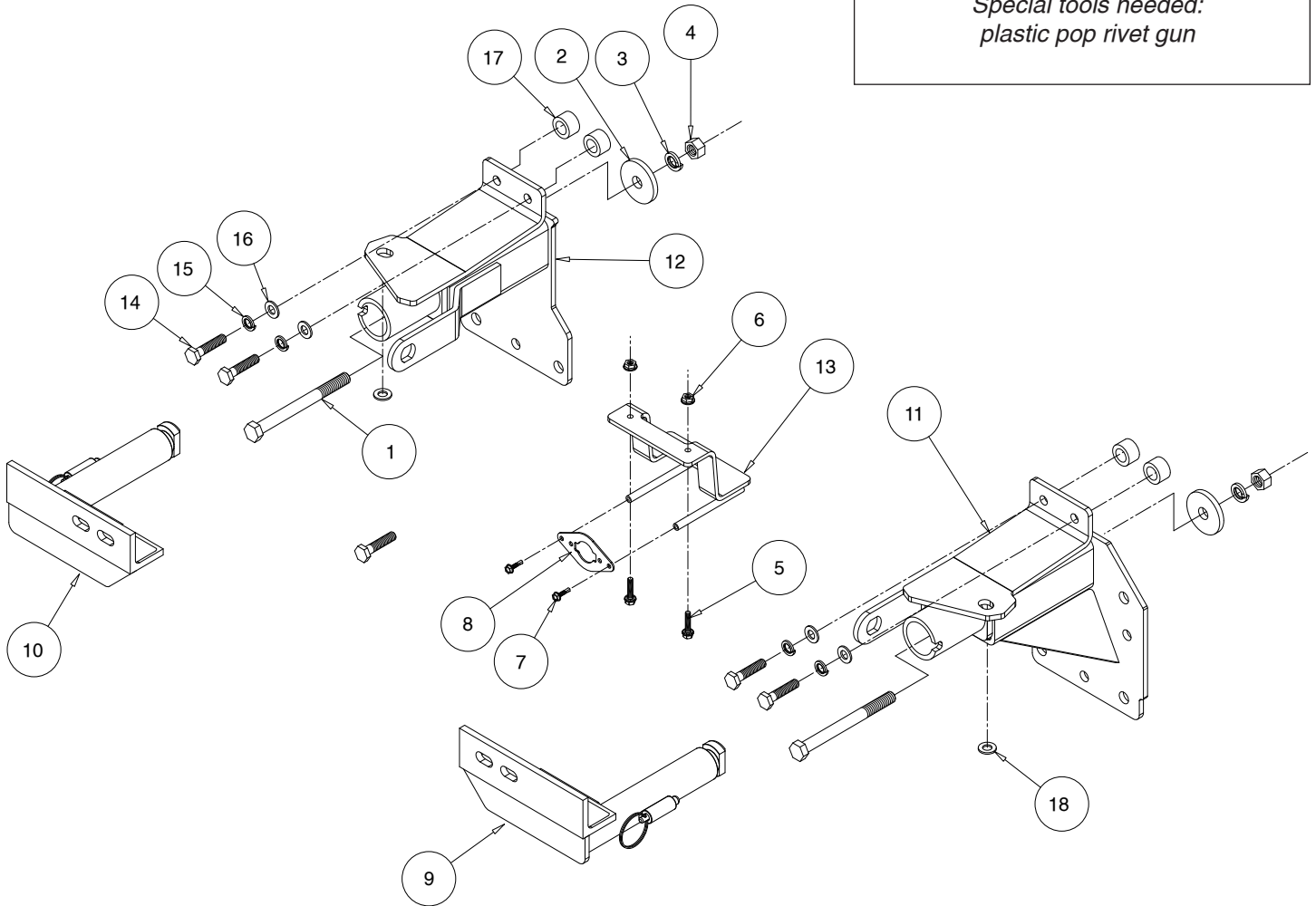

ITEM	QTY	NAME	PART #
1.....	2	1/2" x 5 1/2" BOLT	350108-00
2.....	2	1/2" x 2" O.D. x 1/4" PLATE WASHER	350354-00
3.....	2	1/2" LOCK WASHER	350309-00
4.....	2	1/2" NUT	350258-00
5.....	2	1/4"-20 x 1" WHIZ BOLT	350400-20
6.....	2	1/4"-20 WHIZ NUT	350251-20
7.....	2	#10-16 x 3/4" SELF DRILLING SCREW	350247-35
8.....	1	WIRE PLUG PLATE	A003801
9.....	1	DRIVER SIDE ARM	C003301
10.....	1	PASSENGER SIDE ARM	C003302
11.....	1	DRIVER SIDE RECEIVER	C003303
12.....	1	PASSENGER SIDE RECEIVER	C003304
13.....	1	WIRE PLUG BRACKET	C003305
14.....	4	M10 x 1.25 x 45 mm BOLT	356204-00
15.....	4	M10 LOCK WASHER	355715-00
16.....	4	M10 FLAT WASHER	355710-00
17.....	4	1" O.D. x 0.188" WALL x 5/8" SPACER	A000156
18.....	2	M10 FENDER WASHER	355716-00
19.....	6	PLASTIC RIVET	350431-00



BASEPLATE KIT INSTALLATION INSTRUCTIONS

KIT# 521451-4

01/03/23
KS

ROADMASTER, Inc. 6110 NE 127th Ave. Vancouver, WA 98682 360-896-0407 fax 360-735-9300 www.roadmasterinc.com

This is one of our crossbar-style baseplates, which allows the visible front portion of the bracket to be easily removed from the front of the vehicle (Fig.A and Fig.B). The bracket consists of two main receiver braces, two removable front braces, and a hardware pack.

The main receiver braces mount to the frame rails and the bumper core. The removable front braces install in the main receiver brace.

Before starting the installation, lay out the kit components in order, as they will be used. This will give you a visual idea of how the components work, and will also confirm that everything is present and accounted for.



IMPORTANT: All baseplates **must** be assembled with all the bolts left loose for final adjustment and positioning (before tightening) unless otherwise instructed. All bolts **must** be torqued for proper strength. If more than one bolt is used per fastening point, the diagram may only show one. Use flat washers over all slotted holes and lock washers on all fasteners.

WARNING

Failure to heed these warnings or follow the installation instructions may result in a voided warranty, loss of towed vehicle, personal injury or death.

- Do not weld or modify this baseplate or its components. Welding or modification will void the warranty.
- Do not use this document as a basis to design/fabricate a baseplate, as it may not show all parts or structural components.
- We strongly recommend professional installation.
- If the towed vehicle has been in an accident, it must be properly repaired before attaching the baseplate. Do not install the baseplate if any structural frame damage is found.
- The installer must use all bolts and parts supplied. If running changes were made by the vehicle manufacturer after this kit was designed, some bolts or other fasteners may no longer be the correct size. It is the installer's responsibility to verify this kit is securely fastened to the vehicle.
- Use Loctite® Red on all bolts used to secure this baseplate. Torque all bolts to the specifications found at the end of these instructions. Do not over-torque the bolts or failure may occur.
- The installer must inspect the baseplate to ensure adequate clearance, particularly around hoses, air conditioner lines, radiators, etc. or non-warranty failure may result.
- Roadmaster manufactures many styles of baseplates. If your baseplate has removable arms, they must be removed before driving the vehicle, unless the arms can be pinned or padlocked in place. If not secured, the arms could vibrate out.
- Some motorhome chassis have such a tight turning radius that you can damage your motorhome, towed vehicle, tow bar or baseplate while turning sharply. Before getting on the road, test your turning radius in an empty parking lot. Turning too sharply could result in non-warranty damage to your towing system, motorhome and/or towed vehicle.
- Do not back up with the towed vehicle attached or non-warranty damage will occur to your towing system or vehicles.
- The safety cables must connect the towing vehicle to the towed vehicle frame to frame, with the cables crossed, with enough slack for sharp turns. See cable instructions for proper routing. Failure to do so will result in non-warranty damage and/or the loss of the towed vehicle.
- This kit is designed for use with ROADMASTER tow bars and ROADMASTER adapters only. Using this kit with other brands, without an approved ROADMASTER adapter, may result in non-warranty damage or injury.
- Receiver extensions and out-of-level towing situations of 3 inches or more. This can cause the system to swing much higher and lower, causing excessive strain on the tow bar, baseplate and frame. That can cause the towing system to fail, causing property damage, personal injury or even death. If you must use a receiver extension or drop hitch to tow, it will reduce your receiver's weight capacity by 1/3 to avoid damaging your system. Never use more than one extension and/or drop hitch, as this will void your warranty.
- Every 3,000 miles, the owner must inspect all mounting points for cracks or fatigue, and check the fasteners for proper torque, according to the bolt torque requirements chart on the last page of these instructions.
- The owner must follow the vehicle manufacturer's instructions to prepare the vehicle for towing. Failure to do so may cause severe damage to the vehicle.
- This baseplate is only warranted for the original installation. Installing a used baseplate on another vehicle is not recommended and will void the warranty.



BASEPLATE KIT INSTALLATION INSTRUCTIONS

KIT# 521451-4

01/03/23
KS

ROADMASTER, Inc. 6110 NE 127th Ave. Vancouver, WA 98682 360-896-0407 fax 360-735-9300 www.roadmasterinc.com

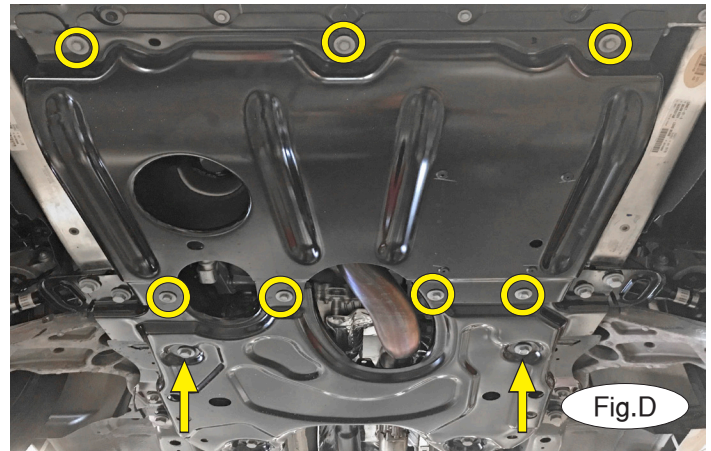
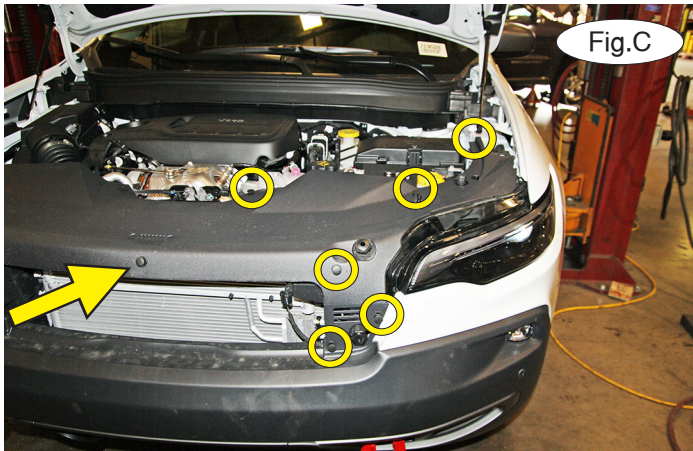

Important: please use all supplied bolts and parts and read all instructions carefully before beginning this installation. The majority of questions you may have can be answered within the text, and proper installation will ensure safe and secure travel.

1. For '21 and later Cherokee models with Elite package: Proceed to the fascia removal instructions supplement. For all other models: On each side, remove six plastic fasteners attaching the radiator cover to the core support (Fig.C – circles). There is also one fastener in the middle (Fig.C – arrow).

2. Remove seven 13mm bolts attaching the skid plate to the subframe (Fig.D). *Note:* Due to manufacturing variances while installing the skid plates, there may be an additional two 13mm bolts that will need to be removed as well (arrows).

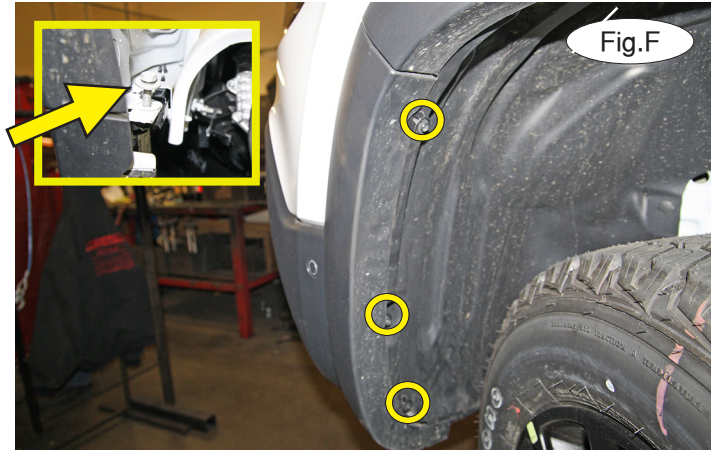
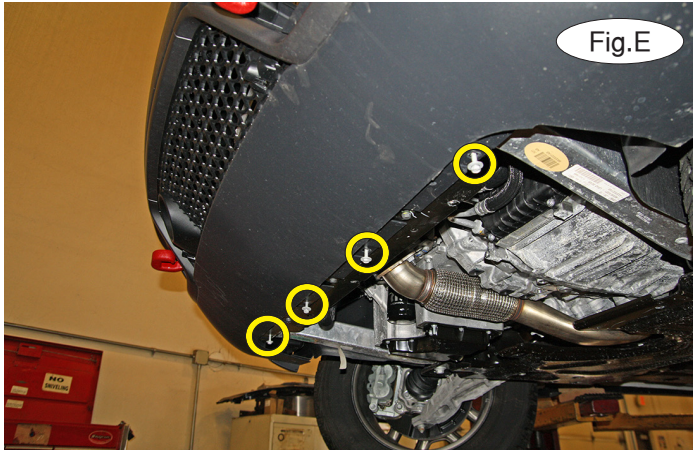

3. Remove four 10mm bolts attaching the fascia to the core support (Fig.E).

4. On each side, remove three 8mm screws attaching the fender liner to the fascia (Fig.F). Then, pull back the fender liner and remove one 10mm bolt (Fig.F – inset). *Note:* You will also need to use a 1/4" drill bit to remove the plastic pop rivet attaching the bottom of the fascia to the fender liner. *Note:* Due to manufacturing variances, there may be four screws and three rivets instead.

5. On the driver's side only, disconnect the electrical connectors (Fig.G). **Note: Make certain that the vehicle is not turned on while this connector is unplugged or it may trigger the 'Check Engine' light to illuminate.**

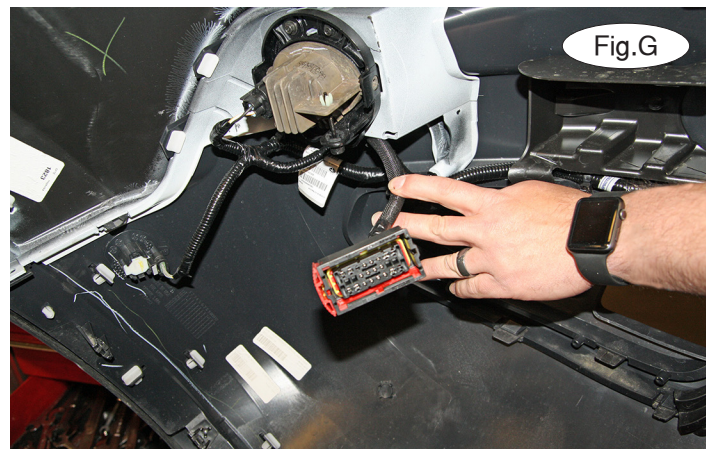



BASEPLATE KIT INSTALLATION INSTRUCTIONS

KIT# 521451-4

01/03/23
KS

ROADMASTER, Inc. 6110 NE 127th Ave. Vancouver, WA 98682 360-896-0407 fax 360-735-9300 www.roadmasterinc.com

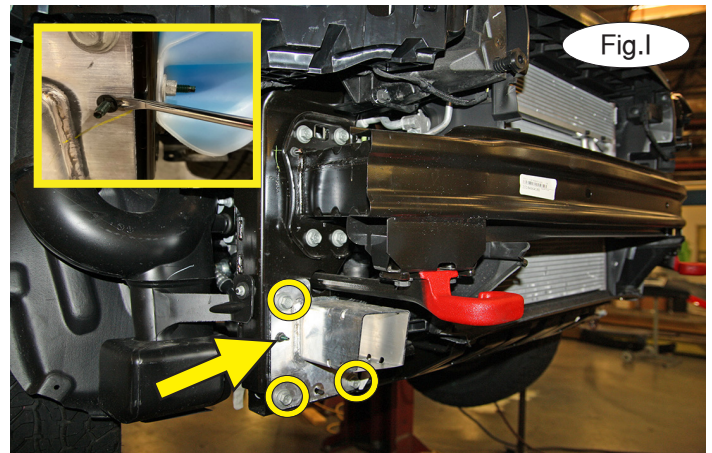

6. On each side, pull out to release the fascia clips (Fig.H) and set the fascia aside for now. *Note:* Due to manufacturing variances, the fender trim may be one piece instead of two. If that is the case, pull out to release the clips before removing the fascia (Fig.H – inset).

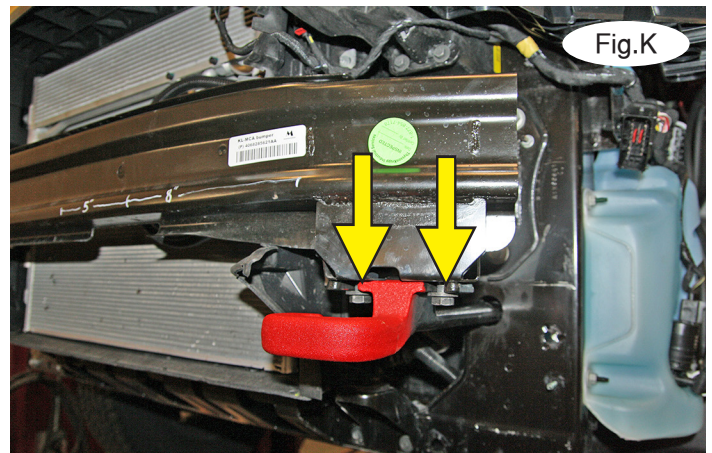
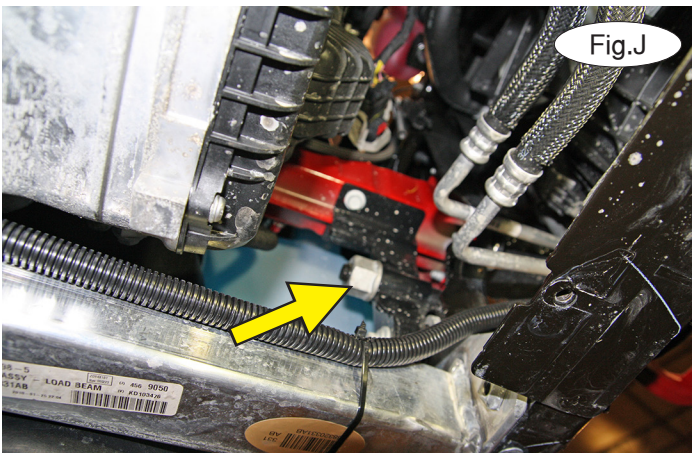

7. On each side, remove three bolts using a 15mm socket (Fig.I – circles) and then remove a 10mm nut (Fig.I – arrow) attaching the bumper horn to the frame rail. The bumper horns will not be replaced. *Note:* Due to manufacturing variances, there may be a star washer instead of a nut. If it is, remove it with a panel tool or flathead screwdriver (Fig.I – inset).

8. On each side, remove a 30mm nut attaching the tow hook to the back of the frame rail (Fig.J) and two 16mm bolts attaching the tow hook to the frame (Fig.K). The tow hooks will not be replaced.

9. On each side, use a 15mm socket to remove the two 10mm bolts attaching the bottom of the bumper core to the frame (Fig.L).

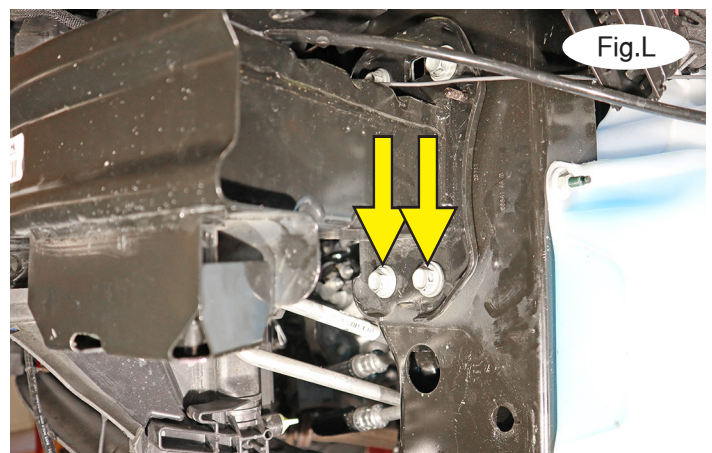



BASEPLATE KIT INSTALLATION INSTRUCTIONS

KIT# 521451-4

01/03/23
KS

ROADMASTER, Inc. 6110 NE 127th Ave. Vancouver, WA 98682 360-896-0407 fax 360-735-9300 www.roadmasterinc.com

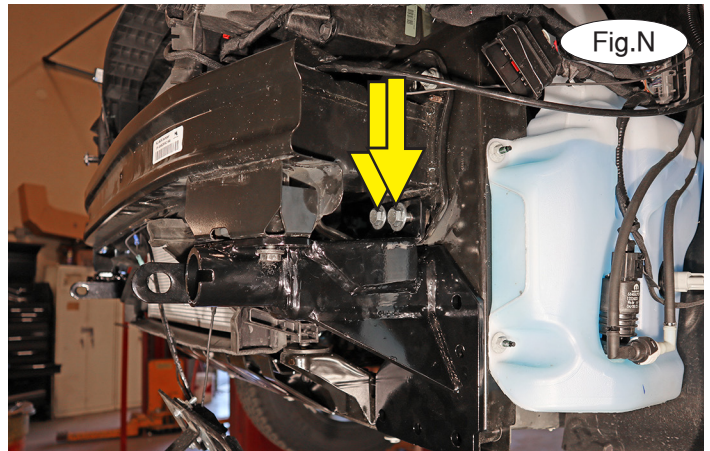

10. Place a M10 lock washer, M10 flat washer and Loctite on two M10 x 1.25 x 45mm bolts. Working on the driver's side only, use the drawing on page 1 as a reference and place the side-specific brace over the two mounts you exposed in step 9 (Fig.M). Then, place two 1" O.D. x .188 wall x 5/8" pipe spacers between the baseplate and the mounts. Now, install the prepared bolts (Fig.N).

11. Replace the bumper horn hardware you removed in step 7 and then use one of the tow hook mount bolts with a supplied M10 fender washer for the fourth bolt. Using Loctite and a torque wrench, tighten this bolt to 50 ft-lbs (Fig.O).

IMPORTANT! Under no circumstances should you use an impact gun to tighten it. If you do, you will break the nut sert inside the bumper core and will need to repair it, or failure of the baseplate will result. If you break the nut sert, contact Roadmaster for instructions on how to access it for repair.

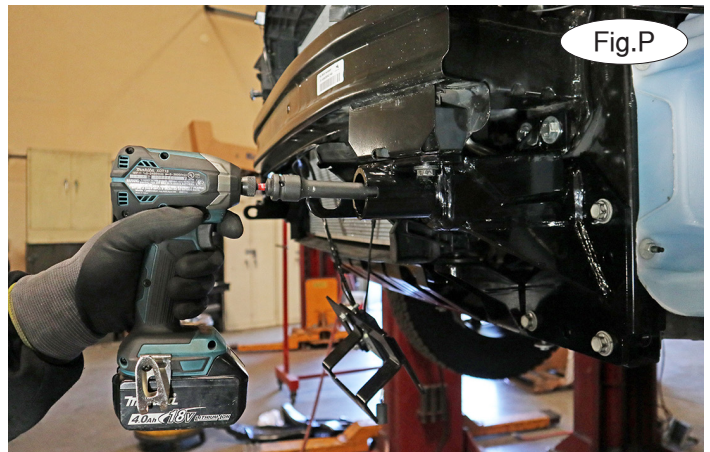

12. Use an extension and socket to place a 1/2" x 5 1/2" bolt with Loctite through the receiver arm and into the frame (Fig.P). Finish the bolt with a 1/2" plate washer, 1/2" lock washer and 1/2" nut (Fig.Q).

13. Tighten all remaining bolts to the requirements found at the end of these instructions.

14. Repeat steps 10 through 13 on the passenger side.

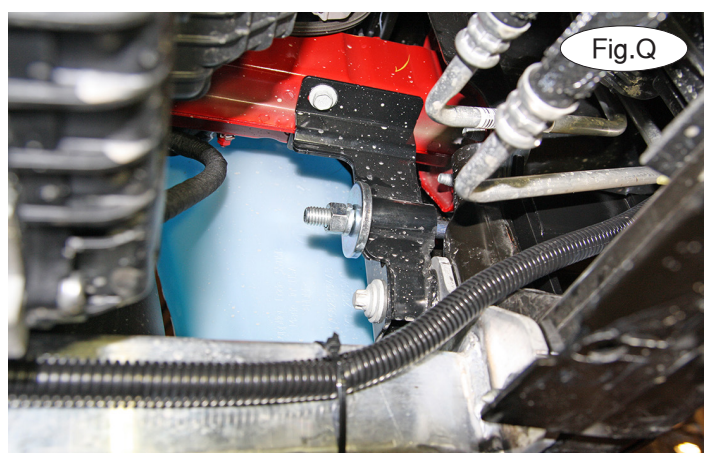



BASEPLATE KIT INSTALLATION INSTRUCTIONS

KIT# 521451-4

01/03/23
KS

ROADMASTER, Inc. 6110 NE 127th Ave. Vancouver, WA 98682 360-896-0407 fax 360-735-9300 www.roadmasterinc.com

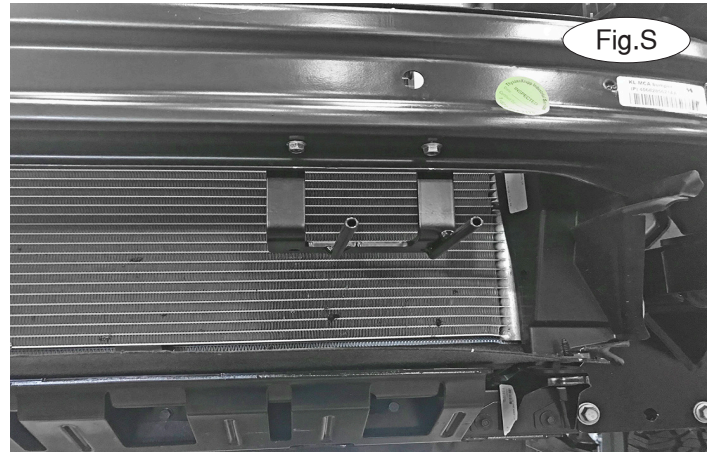

15. If you will be using the wiring plug plate that we provide, measure over $8\frac{3}{4}$ " from the edge of the driver's side tow hook mount and drill a $\frac{1}{4}$ " hole (Fig.R). Then, measure over another $3\frac{1}{2}$ " and drill a second hole. Mount the wiring plug plate to the bottom of the bumper core using the supplied two $\frac{1}{4}$ -20 x 1" bolts and whiz nuts (Fig.S).

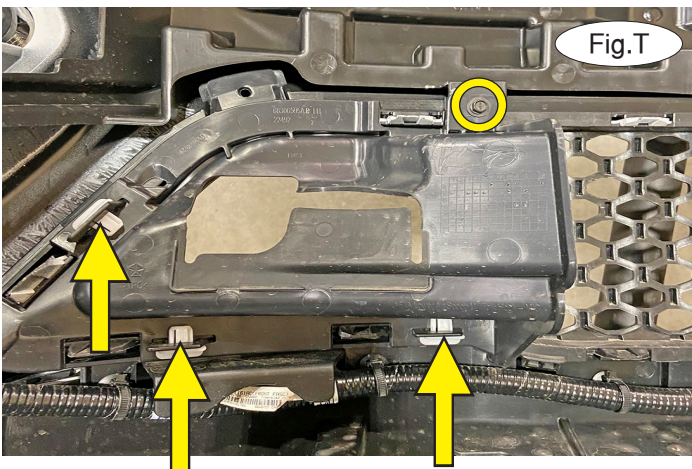

16. **For '21 and later models only:** On each side, remove one 7mm screw (Fig.T – circle) and release three keeper clips (Fig.T – arrows) to remove the tow hook cover, if the vehicle is so equipped. Set the cover aside, as it will be not replaced. Then, reinstall the 7mm screw.

If you are using our wiring plug mount or mounting a Brakeaway switch: Trim the fascia as shown in Figure U to allow clearance.

17. Reinstall the fascia, reversing steps 1 through 6.

18. On each side, insert the removable front arm into the front receiver 90 degrees from its final towing position, depressing the spring-loaded pin against the receiver. Twist back 90 degrees until the spring-loaded pin snaps into place in the notch on the receiver, locking the arm into place in its final towing position. **Please note: It is the owner's responsibility to ensure the locking of the pins before towing. Otherwise, failure of the towing system will result.**

19. Install the tow bar to the mounting bracket according to the manufacturer's instructions.



BASEPLATE KIT INSTALLATION INSTRUCTIONS

KIT# 521451-4

01/03/23
KS

ROADMASTER, Inc. 6110 NE 127th Ave. Vancouver, WA 98682 360-896-0407 fax 360-735-9300 www.roadmasterinc.com

IMPORTANT!

Safety cables are required by law. When towing, connect safety cables to the safety cable tabs (Fig.V). Make certain there is adequate slack in the cables to allow a full turning radius; otherwise, damage will result. If necessary, longer cables or cable extensions are availableW



Fig.V

Three options for attaching the wiring plug to the main receiver brace

For six-wire plugs: Use the two supplied 3/4" self-tapping screws to attach the electrical plug directly to the rods on the front of the main receiver brace.

For four-wire round plugs: Attach to the plug mounting plate and then use the two supplied 3/4" self-tapping screws to attach the mounting plate to the rods on the front of the main receiver brace.

For four-wire flat plugs: Place the plug through the mounting plug plate, and then secure it using the supplied zip tie on the front of the plug (Fig.U). Use the two supplied 3/4" self-tapping screws to attach the mounting plate to the rods on the front of the main receiver brace.

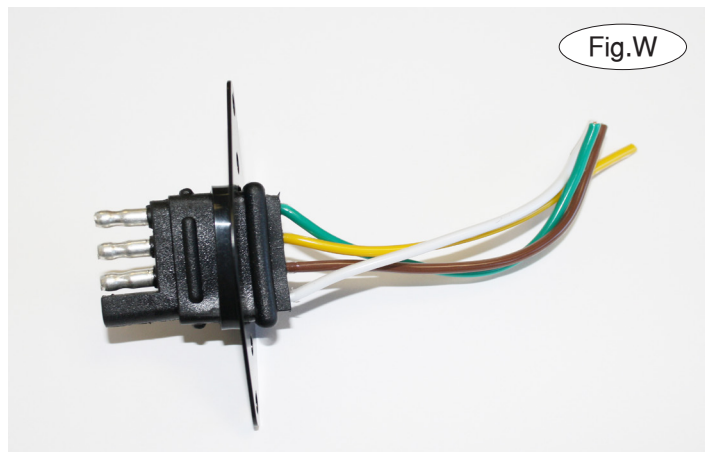

Fig.W

BOLT TORQUE REQUIREMENTS

Note: The torque values represented below are intended as general guidelines. Torque requirements for specific applications may vary. Roadmaster does not warrant this information to be accurate for all applications and disclaims all liability for any claims or damages which may result from its use.

STANDARD BOLTS

Thread Size	Grade	Torque
5/16-18	5	13 ft./lb.
3/8-16	5	23 ft./lb.
7/16-14	5	37 ft./lb.
1/2-13	5	57 ft./lb.
5/8-11	5	112 ft./lb.

METRIC BOLTS

Thread Size	Grade	Torque
6mm-1.0	8.8	6 ft./lb.
8mm-1.0	8.8	18 ft./lb.
8mm-1.25	8.8	16 ft./lb.
10mm-1.25	8.8	36 ft./lb.
10mm-1.5	8.8	31 ft./lb.

METRIC BOLTS

Thread Size	Grade	Torque
12mm-1.25	8.8	64 ft./lb.
12mm-1.5	8.8	60 ft./lb.
12mm-1.75	8.8	55 ft./lb.
14mm-2.0	8.8	88 ft./lb.



BASEPLATE KIT INSTALLATION INSTRUCTIONS

KIT# 521451-4

01/03/23
KS

ROADMASTER, Inc. 6110 NE 127th Ave. Vancouver, WA 98682 360-896-0407 fax 360-735-9300 www.roadmasterinc.com

Fascia Removal Supplement for '21 and later Cherokee models with Elite package

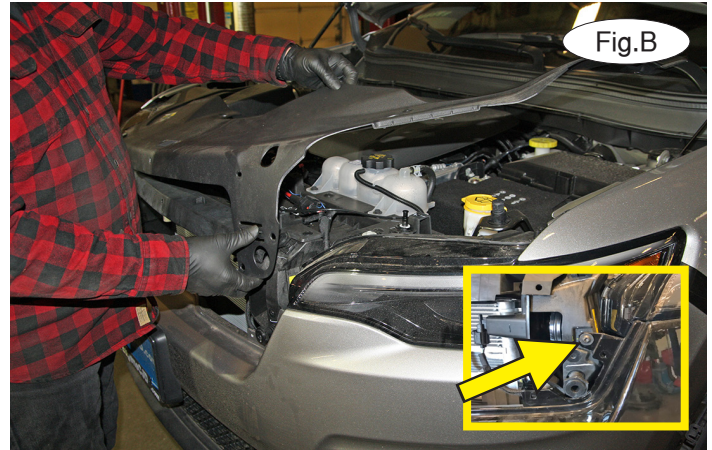
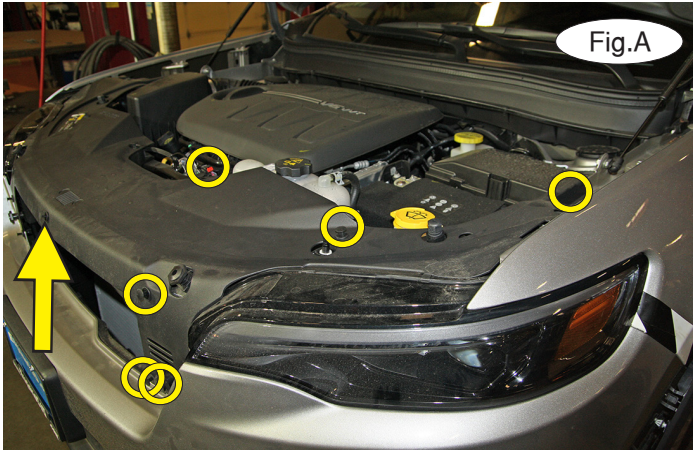

1. **Important:** please use all supplied bolts and parts and read all instructions carefully before beginning this installation. The majority of questions you may have can be answered within the text, and proper installation will ensure safe and secure travel. Now, on each side, remove six plastic fasteners attaching the radiator cover to the core support (Fig.A – circles). There is also one fastener in the middle (Fig.A – arrow). Remove the radiator cover and set it aside for now (Fig.B). *Note:* Due to manufacturing variances, there may also be a T30 Torx on each side (Fig.B – inset).



2. On each side, remove four 10mm bolts attaching the splash shield to the fascia (Fig.C). Remove the splash shield and set it aside for now.

3. On each side, use a 1/4" drill bit to remove three rivets attaching the air deflector to the bottom of the fascia (Fig.D). Slide each air deflector toward the center of the vehicle to remove it.



BASEPLATE KIT INSTALLATION INSTRUCTIONS

KIT# 521451-4

01/03/23
KS

ROADMASTER, Inc. 6110 NE 127th Ave. Vancouver, WA 98682 360-896-0407 fax 360-735-9300 www.roadmasterinc.com



4. On each side, remove four 8mm screws attaching the fender liner to the fascia (Fig.E). *Note:* Due to manufacturing variances, two of the screws may be plastic fasteners instead. Pull back the fender liner and remove one 10mm bolt (Fig.E – inset). Now, on each side, pull out on the corner of the fascia to release the locking strip and the wheel well trim clips (Fig.F). Then, use a panel tool or similar to carefully pull down on a plastic retaining clip (Fig.G) and at the same time, pull out on the corner of the fascia to release it (Fig.H).

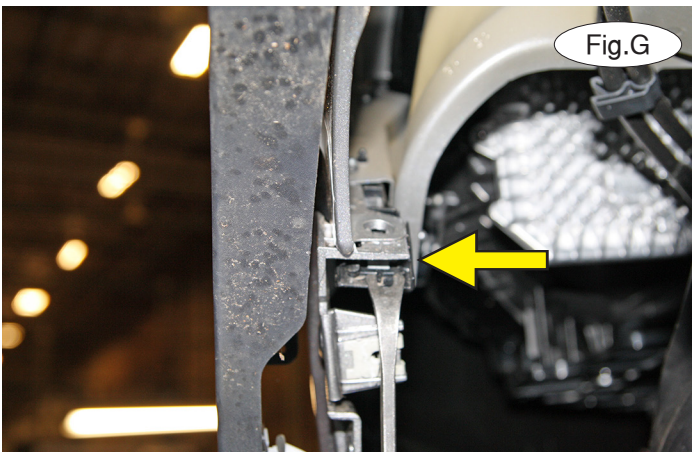

5. On the driver's side only, disconnect the electrical connector (Fig.I) and then remove the fascia and set it aside. **Note: Make certain that the vehicle is not turned on while the connector is unplugged or it may trigger the 'Check Engine' light to illuminate.**

Now, return to step 7 in the regular instructions to finish the installation.

