



# BASEPLATE KIT INSTALLATION INSTRUCTIONS

**KIT# 521459-4**

04/25  
RS

ROADMASTER, Inc.

6110 NE 127th Ave.

Vancouver, WA 98682

360-896-0407

www.RoadmasterInc.com

## What You'll Need

Second person for lifting  
 Ratchets  
 8, 10, 18mm short sockets  
 5/16", 9/16", 3/4" sockets  
 9/16", 3/4" wrenches

17/32" bit and drill  
 Two clean rags  
 Needlenose pliers  
 Reciprocating saw  
 Permanent or paint marker

Utility knife  
 Torque wrench  
 Threadlocker

Need Help? Call Toll-Free

1-800-669-9690

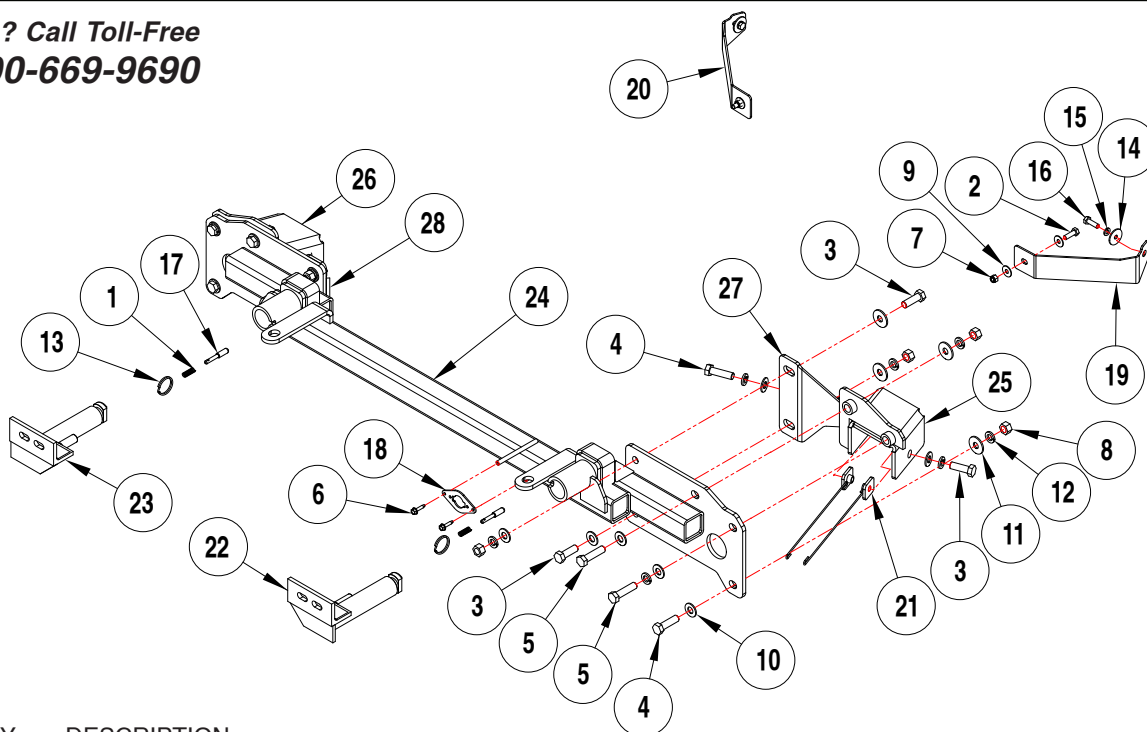

ITEM.....	QTY.....	DESCRIPTION .....	PART .....
1.....	2.....	SPRING .....	200146-00
2.....	2.....	5/16" x 1" BOLT .....	350030-00
3.....	6.....	1/2" x 1 1/2" BOLT .....	350095-00
4.....	4.....	1/2" x 1 3/4" BOLT .....	350096-00
5.....	4.....	1/2" X 2" BOLT .....	350097-00
6.....	2.....	#10 x 3/4" SELF DRILLING SCREW .....	350247-35
7.....	2.....	5/16" NYLON INSERT LOCK NUT .....	350253-00
8.....	8.....	1/2" HEX NUT .....	350258-00
9.....	4.....	5/16" FLAT WASHER .....	350302-00
10.....	14.....	1/2" SAE WASHER .....	350308-20
11.....	8.....	1/2" FLAT WASHER .....	350308-00
12.....	14.....	1/2" LOCK WASHER .....	350309-00
13.....	2.....	RING .....	350520-00
14.....	2.....	M8 FENDER WASHER .....	355702-00
15.....	2.....	M8 LOCK WASHER .....	355705-00
16.....	2.....	M8 x 1.25 x 25 mm BOLT .....	356008-00
17.....	2.....	LOCK PIN .....	A000008
18.....	1.....	WIRE PLUG PLATE .....	A003801
19.....	1.....	DRIVER SIDE FASCIA MOUNT .....	B004058
20.....	1.....	PASSENGER SIDE FASCIA MOUNT .....	B004059
21.....	4.....	1 1/4" x 1 1/2" THREADED BACKING PLATE W/ 10" ROD .....	C002501
22.....	1.....	DRIVER SIDE ARM .....	C003671
23.....	1.....	PASSENGER SIDE ARM .....	C003672
24.....	1.....	MAIN RECEIVER .....	C003673
25.....	1.....	DRIVER SIDE REAR MOUNT .....	C003885
26.....	1.....	PASSENGER SIDE REAR MOUNT .....	C003886
27.....	1.....	DRIVER SIDE BRACE .....	C003887
28.....	1.....	PASSENGER SIDE BRACE .....	C003888
29.....	1.....	1/4" x 3/4" SELF DRILLING SCREW .....	357250-00



# BASEPLATE KIT INSTALLATION INSTRUCTIONS

**KIT# 521459-4**

04/25  
RS

ROADMASTER, Inc.

6110 NE 127th Ave.

Vancouver, WA 98682

360-896-0407

www.RoadmasterInc.com

**IMPORTANT:** All baseplates **must** be assembled with all the bolts left loose for final adjustment and positioning (before tightening) unless otherwise instructed. All bolts **must** be torqued for proper strength. If more than one bolt is used per fastening point, the diagram may only show one. Use flat washers over all slotted holes and lock washers on all fasteners.

## **WARNING**

Failure to heed these warnings or follow the installation instructions may result in a voided warranty, loss of towed vehicle, personal injury or death.

- Do not weld or modify this baseplate or its components. Welding or modification will void the warranty.
- Do not use this document as a basis to design/fabricate a baseplate, as it may not show all parts or structural components.
- We strongly recommend professional installation.
- If the towed vehicle has been in an accident, it must be properly repaired before attaching the baseplate. **Do not install the baseplate if any structural frame damage is found.**
- The installer must use all bolts and parts supplied. If running changes were made by the vehicle manufacturer after this kit was designed, some bolts or other fasteners may no longer be the correct size. **It is the installer's responsibility to verify this kit is securely fastened to the vehicle.**
- Use **Loctite® Red on all bolts used to secure this baseplate.** Torque all bolts to the specifications found at the end of these instructions. Do not over-torque the bolts or failure may occur.
- The installer must inspect the baseplate to ensure adequate clearance, particularly around hoses, air conditioner lines, radiators, etc. or non-warranty failure may result.
- Roadmaster manufactures many styles of baseplates. **If your baseplate has removable arms, they must be removed before driving the vehicle, unless the arms can be pinned or padlocked in place.** If not secured, the arms could vibrate out.
- Some motorhome chassis have such a tight turning radius that you can damage your motorhome, towed vehicle, tow bar or baseplate while turning sharply. **Before getting on the road, test your turning radius in an empty parking lot.** Turning too sharply could

result in non-warranty damage to your towing system, motorhome and/or towed vehicle.

- Do not back up with the towed vehicle attached or non-warranty damage will occur to your towing system or vehicles.
- The safety cables must connect the towing vehicle to the towed vehicle frame to frame, with the cables crossed, with enough slack for sharp turns. See cable instructions for proper routing. Failure to do so will result in non-warranty damage and/or the loss of the towed vehicle.
- This kit is designed for use with ROADMASTER tow bars and ROADMASTER adapters only. **Using this kit with other brands, without an approved ROADMASTER adapter, may result in non-warranty damage or injury.**
- Receiver extensions and out-of-level towing situations of 3 inches or more. This can cause the system to swing much higher and lower, causing excessive strain on the tow bar, baseplate and frame. That can cause the towing system to fail, causing property damage, personal injury or even death. **If you must use a receiver extension or drop hitch to tow, it will reduce your receiver's weight capacity by 1/3 to avoid damaging your system. Never use more than one extension and/or drop hitch, as this will void your warranty.**
- Every 3,000 miles, the owner must inspect all mounting points for cracks or fatigue, and check the fasteners for proper torque, according to the bolt torque requirements chart on the last page of these instructions.
- The owner must follow the vehicle manufacturer's instructions to prepare the vehicle for towing. Failure to do so may cause severe damage to the vehicle.
- This baseplate is only warranted for the original installation. Installing a used baseplate on another vehicle is not recommended and will void the warranty.

## About this kit:

This is one of our direct connect-style series, which allows the visible front portion of the baseplate to be easily removed from the front of the vehicle (Fig.A and Fig.B).

Before starting the installation, lay out the kit components in order, as they will be used. This will give you a visual idea of how the components work, and will also confirm that everything is present and accounted for.

**IMPORTANT:** All illustrations and specifications contained herein are based on the latest information available at the time of publication approval. ROADMASTER, INC. reserves the right to make changes at any time without notice in material, specification and models or to discontinue models.





# BASEPLATE KIT INSTALLATION INSTRUCTIONS

**KIT# 521459-4**

04/25  
RS

ROADMASTER, Inc.

6110 NE 127th Ave.

Vancouver, WA 98682

360-896-0407

www.RoadmasterInc.com

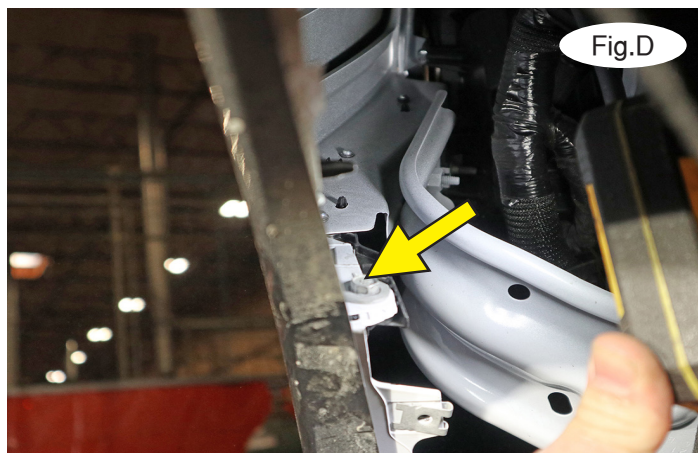

**Important:** Please use all supplied hardware and read through these instructions carefully before beginning this installation. The majority of questions you may have can be answered within the text, and proper installation will ensure safe and secure travel

1. On each side, remove four 8mm screws attaching the fender liner to the fascia (Fig.C). Then, pull back the fender liner and remove one 10mm bolt attaching the fascia to the fender (Fig.D).

2. On each side, carefully peel back the fender trim and disconnect the marker light wiring harness as soon as possible, as it is very short and you risk damaging it if you are not careful (Fig.E). Continue releasing the clips on the trim piece until

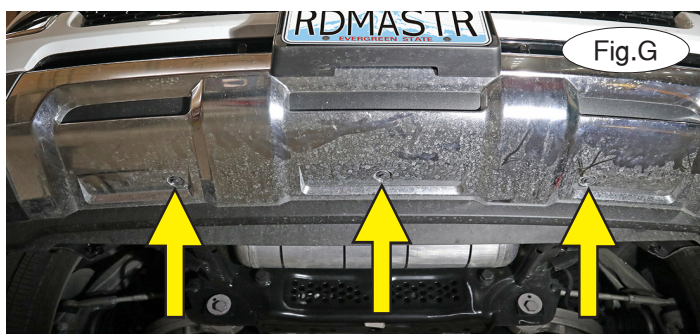

approximately midway over the tire. Use a soft rag to prop it away from the vehicle (Fig.F).

3. Remove three 10mm bolts attaching the bottom of the fascia to the subframe (Fig.G).

4. With the assistance of a second person, release the locking tab at the fender seam (Fig.H – inset) and pull outward to release the clips (Fig.H). On each side, unplug the wiring harness (Fig.I, Next Page) and set the fascia aside.

5. On each side, remove three 18mm nuts attaching the bumper core to the frame (Fig.J, Next Page). It will not be replaced.

6. If the vehicle is equipped with a lower air dam, unplug the harness on the driver's side (Fig.K, Next Page) and then, on each side, remove two 13mm nuts attaching the air dam to the frame (Fig.L, Next Page). Set the air dam aside for now.

Continues on next page...



# BASEPLATE KIT INSTALLATION INSTRUCTIONS

**KIT# 521459-4**

04/25  
RS

ROADMASTER, Inc.

6110 NE 127th Ave.

Vancouver, WA 98682

360-896-0407

www.RoadmasterInc.com

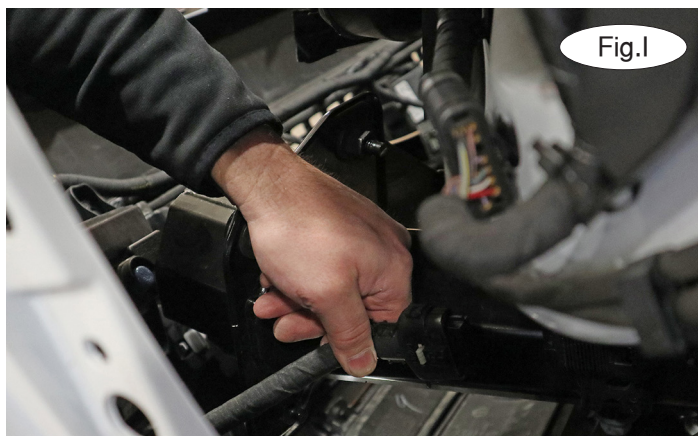

Fig.I

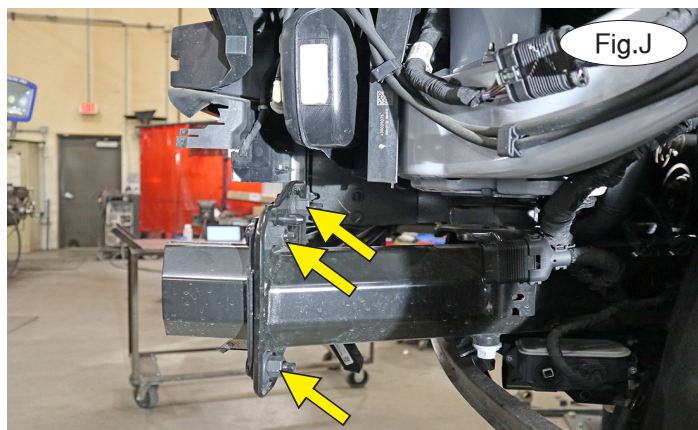

Fig.J

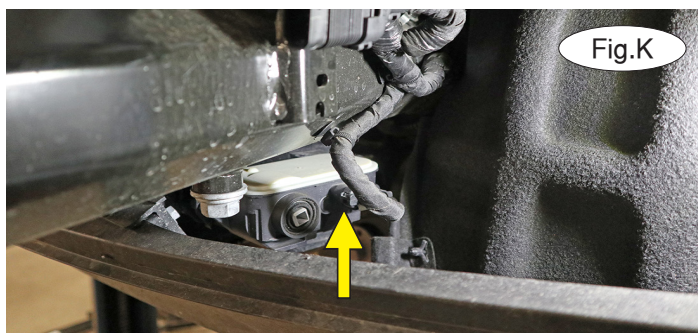

Fig.K

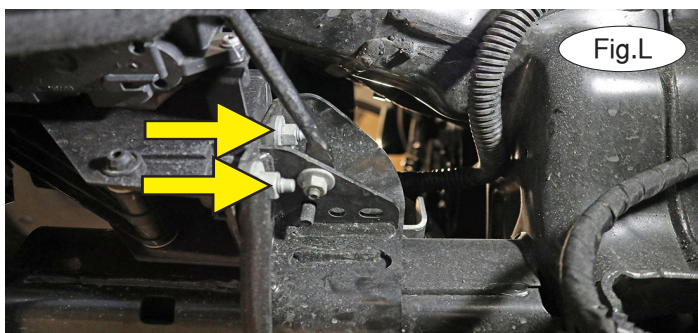

Fig.L

7. On each side, trim the air dam as indicated in Figure M.

8. Starting with one side; prepare one small flat washers and threadlocker over three bolts, prepare two others bolts but do not apply threadlocker on them. With the assistance of a second person, place the baseplate over the ends of the frame and bolt through the baseplate and into the bumper core mounts using your prepared bolts with threadlocker through the bottom most hole. Finish with large flat washers, lock washers and nuts (Fig.N). Finger tighten for now.

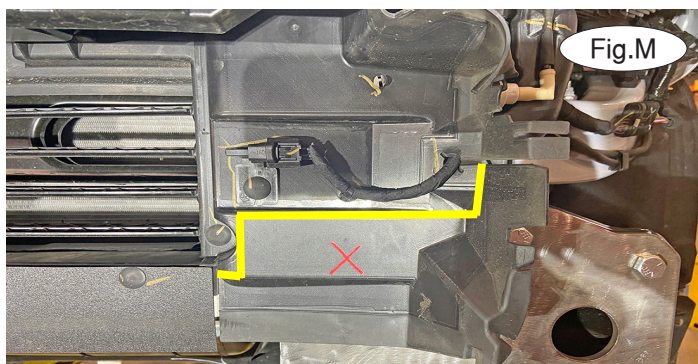

Fig.M

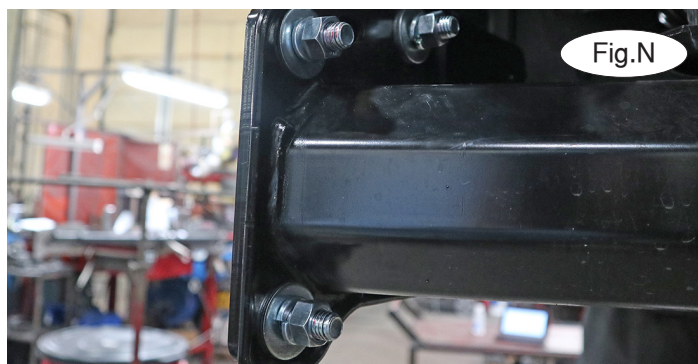

Fig.N

9. Attach the side specific brace onto the subframe, mark the holes where the side specific brace contacts the subframe on both sides of the subframe (Fig.N1).

10. Take the side specific brace off for now, you may need to use a rubber mallet to help remove the side specific brace if it is tight. Drill out the two holes using a 9/16th bit (Fig.P)

11. Reinstall the side specific brace onto the subframe using a washer and bolt through the baseplate and subframe. Torque the top bolts before torquing the bottom bolt.



Fig.N1



# BASEPLATE KIT INSTALLATION INSTRUCTIONS

**KIT# 521459-4**

04/25  
RS

ROADMASTER, Inc.

6110 NE 127th Ave.

Vancouver, WA 98682

360-896-0407

www.RoadmasterInc.com

12. On the passenger side only for air ride equipped: remove four bolts attaching a support brace to the frame (Fig.AA).

13. Inside of the subframe horn, place two threaded backing plates to align with the holes previously drilled for the side specific brace (Fig.Q).

14. Place Threadlocker over a 1/2" x 1 3/4" bolt and 1/2" x 1 1/2" bolt. On the inside, place a lock washer and flat washer on the 1/2" x 1 3/4" bolt. Bolt through the brace into the frame, from the inside facing outwards from the vehicle (Fig.Q) into the threaded backing plate. On the outside, place a lock washer and flat washer under the head of a 1/2" x 1 1/2" bolt and bolt (Fig.O), into the threaded backing plate inside of the frame and brace.

**NOTE:** Depending on manufacturing tolerances and differences, it may be necessary to enlarge (or die grind) the frame horn holes to allow proper access.

15. Tighten the hardware to the bolt torque requirements found at the end of this document.

16. Repeat steps 8-15 for the passenger side of the vehicle.

17. Remove the shock absorption pad by releasing five star clips (Fig.R shows the design of one clip). The pad will not be reinstalled.

18. With the assistance of a second person, hold the fascia as close as possible to its original position and mark it for

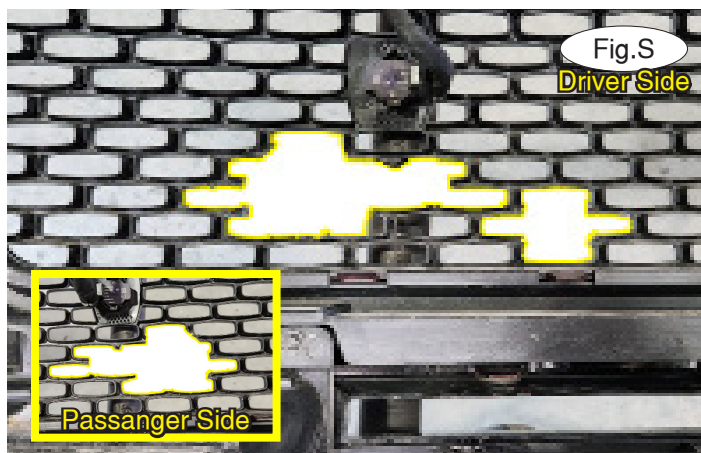
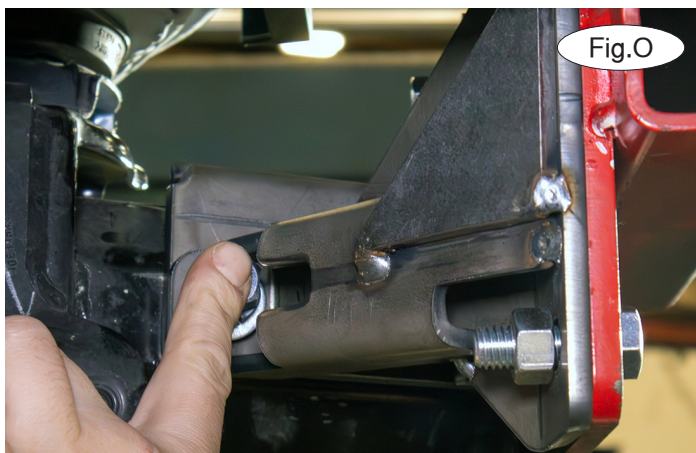
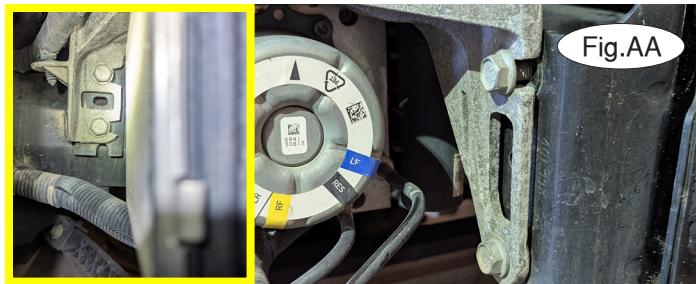



# BASEPLATE KIT INSTALLATION INSTRUCTIONS

**KIT# 521459-4**

04/25  
RS

ROADMASTER, Inc.

6110 NE 127th Ave.

Vancouver, WA 98682

360-896-0407

www.RoadmasterInc.com

trimming. Then, trim the fascia and temporarily replace it for now (Fig.S and inset).

19. Place the bumper core on a flat surface and on each side, remove one 10mm bolt (Fig.T – arrows) and use a ¼" drill bit to drill out two aluminum rivets attaching the plastic fascia stiffener to the back of the bumper core (Fig.T – circles).

20. From underneath the fascia, hold the plastic fascia stiffener in place and replace the 10mm bolts removed in step 4 (Fig.U).

21. On the driver's side, place an M10 lock washer and M10 fender washer over an M10 x 1.5 x 25mm bolt. Locate the side-specific stiffening brace and use the prepared hardware to bolt it to the existing body mount location shown in Figure

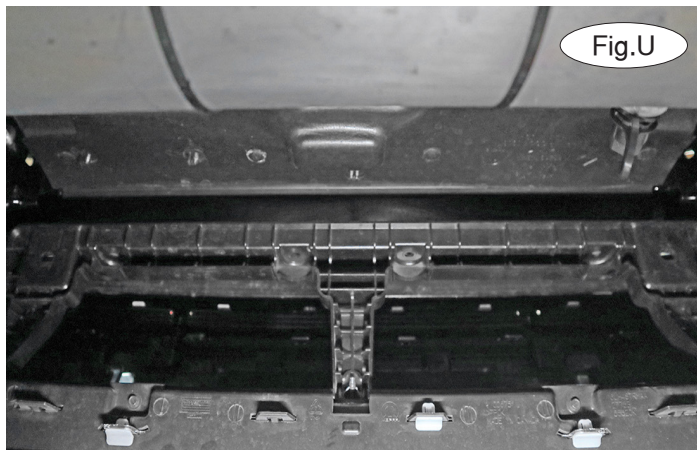
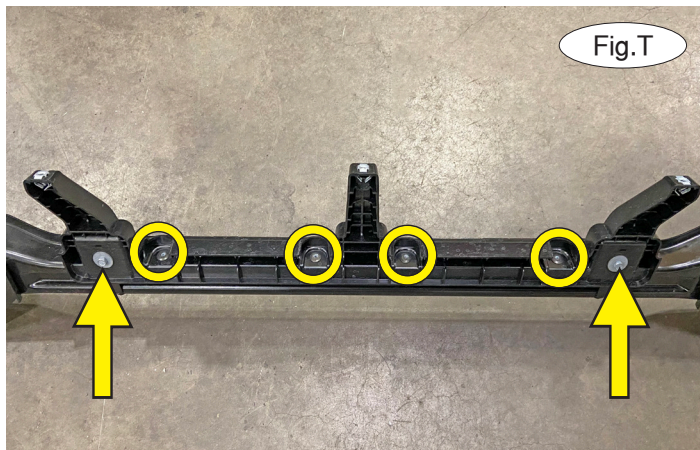

V. Now, use a 5/16" flat washer over a 5/16" x 1" bolt and place it through the mount, through the fascia stiffener, and finish with a 5/16" flat washer and nylock nut (Fig.W). Tighten the bolts to the bolt torque requirements found at the end of these instructions.

22. Repeat step 21 for the passenger side of the vehicle. Then, reinstall the lower air dam by reversing step 6.

23. Finish reinstalling the fascia by reversing steps 1 through 4.

24. On each side, insert the removable front arm into the front receiver 90 degrees from its final towing position, depressing the spring-loaded pin against the receiver. Twist back 90 degrees until the spring-loaded pin snaps into place in the

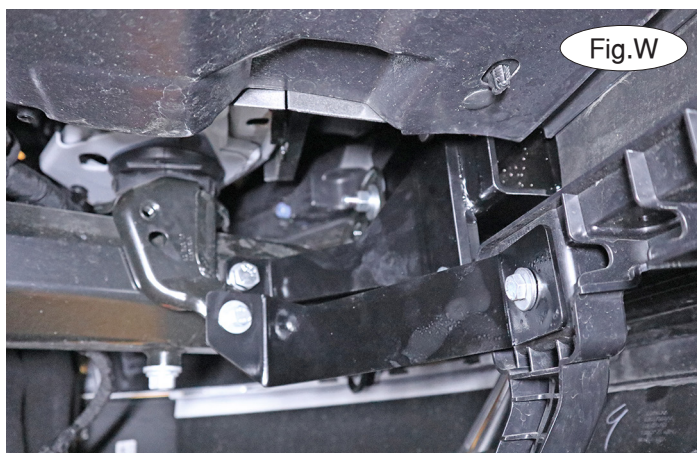



# BASEPLATE KIT INSTALLATION INSTRUCTIONS

**KIT# 521459-4**

04/25  
RS

ROADMASTER, Inc.

6110 NE 127th Ave.

Vancouver, WA 98682

360-896-0407

www.RoadmasterInc.com

notch on the receiver, locking the arm into place in its final towing position.

**Please note: It is the owner's responsibility to ensure the locking of the pins before towing. Otherwise, failure of the towing system will result.**

### IMPORTANT!

**Safety cables are required by law. When towing, connect safety cables to the safety cable tabs illustrated on the separate insert with the drawing and parts list and in Figure X. Make certain there is adequate slack in the cables to allow a full turning radius; otherwise, damage will result. If necessary, longer cables or cable extensions are available.**

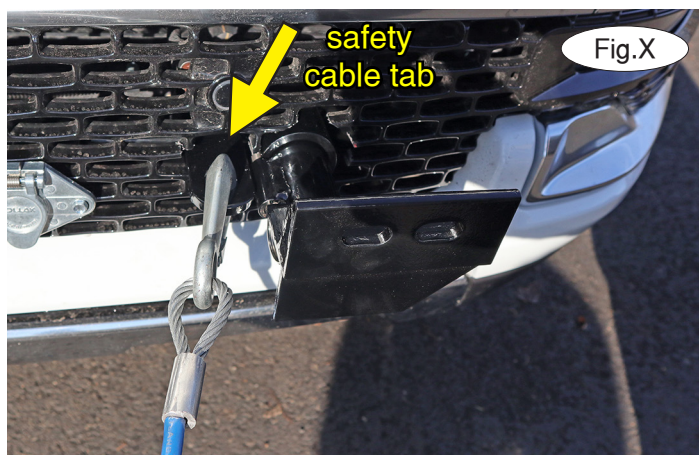

### BOLT TORQUE REQUIREMENTS

Note: The torque values represented below are intended as general guidelines. Torque requirements for specific applications may vary. Roadmaster does not warrant this information to be accurate for all applications and disclaims all liability for any claims or damages which may result from its use.

#### STANDARD BOLTS

Thread Size	Grade	Torque
5/16-18	5	13 ft./lb.
3/8-16	5	23 ft./lb.
7/16-14	5	37 ft./lb.
1/2-13	5	57 ft./lb.
5/8-11	5	112 ft./lb.

#### METRIC BOLTS

Thread Size	Grade	Torque
6mm-1.0	8.8	6 ft./lb.
8mm-1.0	8.8	18 ft./lb.
8mm-1.25	8.8	16 ft./lb.
10mm-1.25	8.8	36 ft./lb.
10mm-1.5	8.8	31 ft./lb.

#### METRIC BOLTS

Thread Size	Grade	Torque
12mm-1.25	8.8	64 ft./lb.
12mm-1.5	8.8	60 ft./lb.
12mm-1.75	8.8	55 ft./lb.
14mm-2.0	8.8	88 ft./lb.