



BASEPLATE KIT INSTALLATION INSTRUCTIONS

KIT# 521464-4

02/29/24
KS

ROADMASTER, Inc. 6110 NE 127th Ave. Vancouver, WA 98682 360-896-0407 fax 360-735-9300 www.roadmasterinc.com

Second person for lifting
Ratchet
8mm, 10mm, 16mm sockets
10mm deep socket

What You'll Need

T40 Torx driver
Panel tool

3/4" socket and wrench
Permanent or paint marker
Torque wrench
Loctite© Red

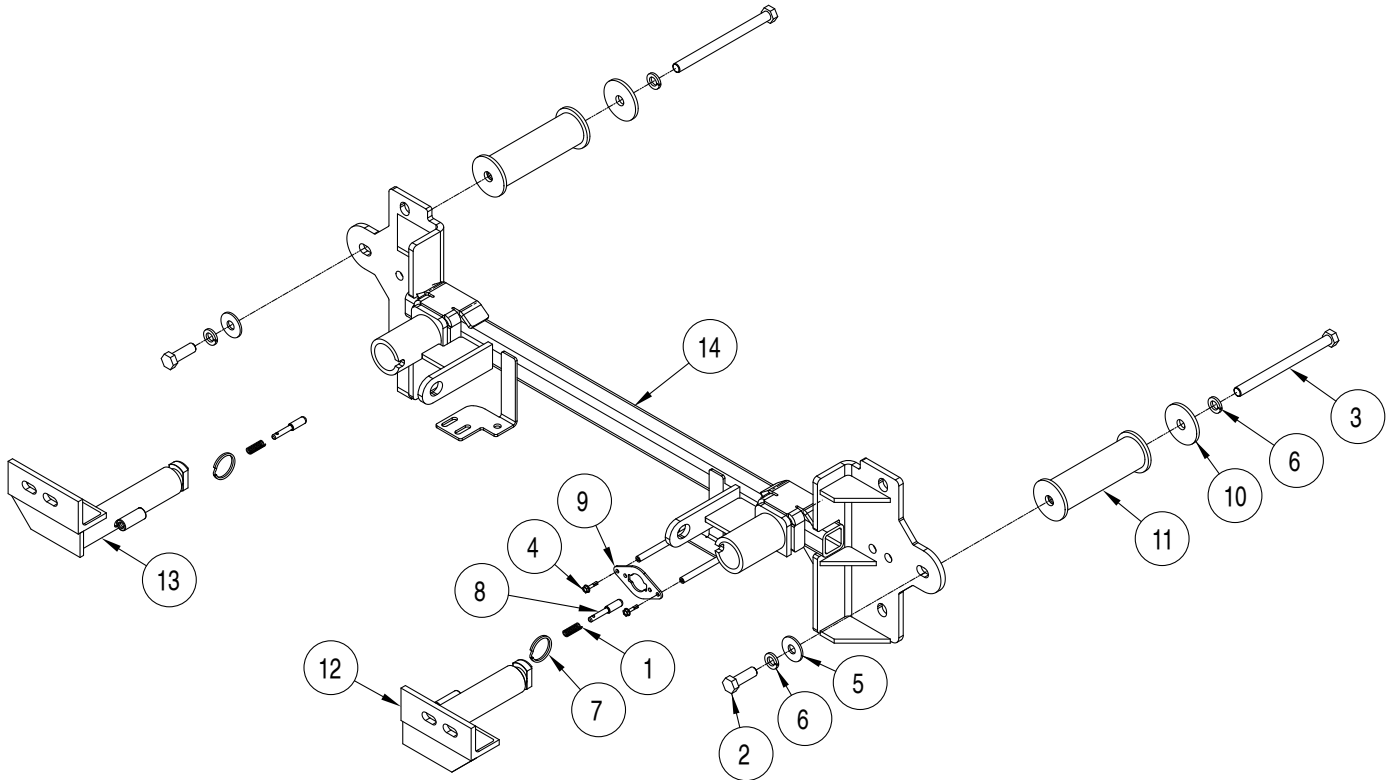

ITEM	QTY	DESCRIPTION	PART NUMBER
1.....	2.....	SPRING.....	200146-00
2.....	2.....	1/2" x 1 1/2" BOLT	350095-00
3.....	2.....	1/2" x 6 1/2" BOLT	350110-00
4.....	2.....	#10 x 3/4" SELF DRILLING SCREW	350247-35
5.....	2.....	1/2" FLAT WASHER	350308-00
6.....	4.....	1/2" LOCK WASHER.....	350309-00
7.....	2.....	RING.....	350520-00
8.....	2.....	LOCK PIN.....	A000008
9.....	1.....	WIRE PLUG PLATE	A003801
10.....	2.....	1/2" PLATE WASHER	A003086
11.....	2.....	REAR BRACE	C003636
12.....	1.....	DRIVER SIDE ARM	C003779
13.....	1.....	PASSENGER SIDE ARM.....	C003780
14.....	1.....	MAIN RECEIVER	C003781



BASEPLATE KIT INSTALLATION INSTRUCTIONS

KIT# 521464-4

02/29/24
KS

ROADMASTER, Inc. 6110 NE 127th Ave. Vancouver, WA 98682 360-896-0407 fax 360-735-9300 www.roadmasterinc.com

This is one of our crossbar-style series, which allows the visible front portion of the baseplate to be easily removed from the front of the vehicle (Fig.A and Fig.B). This kit consists of a main receiver brace, two removable front braces, and a hardware pack.

The main receiver brace mounts to the frame and large tube spacers on each side. The removable front braces install in the main receiver braces.

Before starting the installation, lay out the kit components in order, as they will be used. This will give you a visual idea of how the components work, and will also confirm that everything is present and accounted for.



IMPORTANT: All baseplates **must** be assembled with all the bolts left loose for final adjustment and positioning (before tightening) unless otherwise instructed. All bolts **must** be torqued for proper strength. If more than one bolt is used per fastening point, the diagram may only show one. Use flat washers over all slotted holes and lock washers on all fasteners.

WARNING

Failure to heed these warnings or follow the installation instructions may result in a voided warranty, loss of towed vehicle, personal injury or death.

- Do not weld or modify this baseplate or its components. Welding or modification will void the warranty.
- Do not use this document as a basis to design/fabricate a baseplate, as it may not show all parts or structural components.
- We strongly recommend professional installation.
- If the towed vehicle has been in an accident, it must be properly repaired before attaching the baseplate. Do not install the baseplate if any structural frame damage is found.
- The installer must use all bolts and parts supplied. If running changes were made by the vehicle manufacturer after this kit was designed, some bolts or other fasteners may no longer be the correct size. It is the installer's responsibility to verify this kit is securely fastened to the vehicle.
- Use Loctite® Red on all bolts used to secure this baseplate. Torque all bolts to the specifications found at the end of these instructions. Do not over-torque the bolts or failure may occur.
- The installer must inspect the baseplate to ensure adequate clearance, particularly around hoses, air conditioner lines, radiators, etc. or non-warranty failure may result.
- Roadmaster manufactures many styles of baseplates. If your baseplate has removable arms, they must be removed before driving the vehicle, unless the arms can be pinned or padlocked in place. If not secured, the arms could vibrate out.
- Some motorhome chassis have such a tight turning radius that you can damage your motorhome, towed vehicle, tow bar or baseplate while turning sharply. Before getting on the road, test your turning radius in an empty parking lot. Turning too sharply could result in non-warranty damage to your towing system, motorhome and/or towed vehicle.
- Do not back up with the towed vehicle attached or non-warranty damage will occur to your towing system or vehicles.
- The safety cables must connect the towing vehicle to the towed vehicle frame to frame, with the cables crossed, with enough slack for sharp turns. See cable instructions for proper routing. Failure to do so will result in non-warranty damage and/or the loss of the towed vehicle.
- This kit is designed for use with ROADMASTER tow bars and ROADMASTER adapters only. Using this kit with other brands, without an approved ROADMASTER adapter, may result in non-warranty damage or injury.
- Receiver extensions and out-of-level towing situations of 3 inches or more. This can cause the system to swing much higher and lower, causing excessive strain on the tow bar, baseplate and frame. That can cause the towing system to fail, causing property damage, personal injury or even death. If you must use a receiver extension or drop hitch to tow, it will reduce your receiver's weight capacity by 1/3 to avoid damaging your system. Never use more than one extension and/or drop hitch, as this will void your warranty.
- Every 3,000 miles, the owner must inspect all mounting points for cracks or fatigue, and check the fasteners for proper torque, according to the bolt torque requirements chart on the last page of these instructions.
- The owner must follow the vehicle manufacturer's instructions to prepare the vehicle for towing. Failure to do so may cause severe damage to the vehicle.
- This baseplate is only warranted for the original installation. Installing a used baseplate on another vehicle is not recommended and will void the warranty.



BASEPLATE KIT INSTALLATION INSTRUCTIONS

KIT# 521464-4

02/29/24
KS

ROADMASTER, Inc. 6110 NE 127th Ave. Vancouver, WA 98682 360-896-0407 fax 360-735-9300 www.roadmasterinc.com

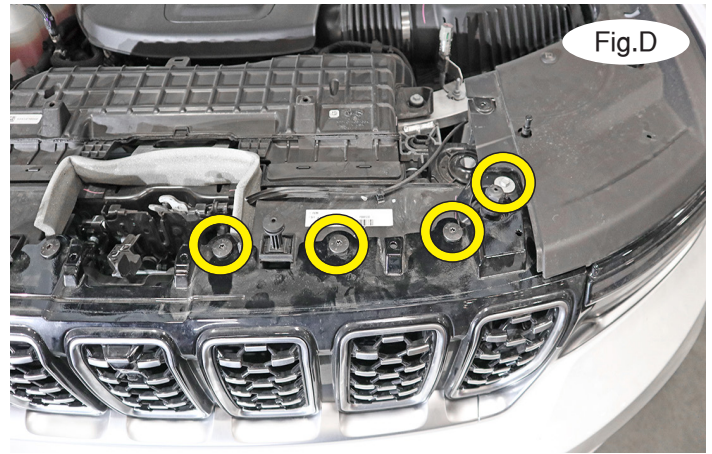
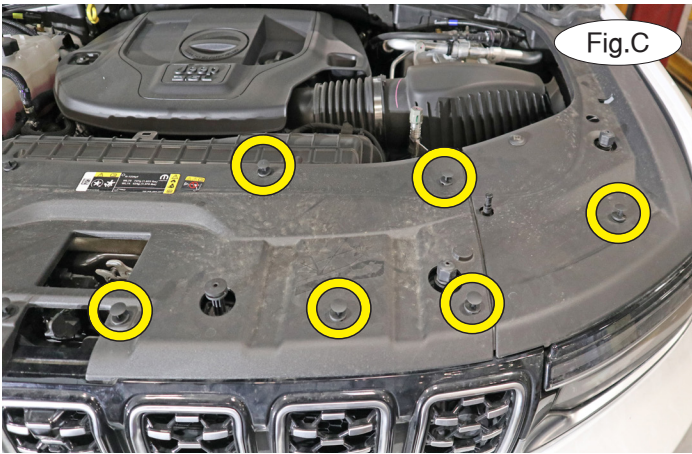

Important: Please use all supplied hardware and read through these instructions carefully before beginning this installation. The majority of questions you may have can be answered within the text, and proper installation will ensure safe and secure travel.

1. On each side, remove six plastic fasteners to remove the radiator cover to the top of the fascia (Fig.C).
2. On each side, remove three T40 Torx bolts and one 10mm bolt attaching the top of the fascia to the radiator support (Fig.D).

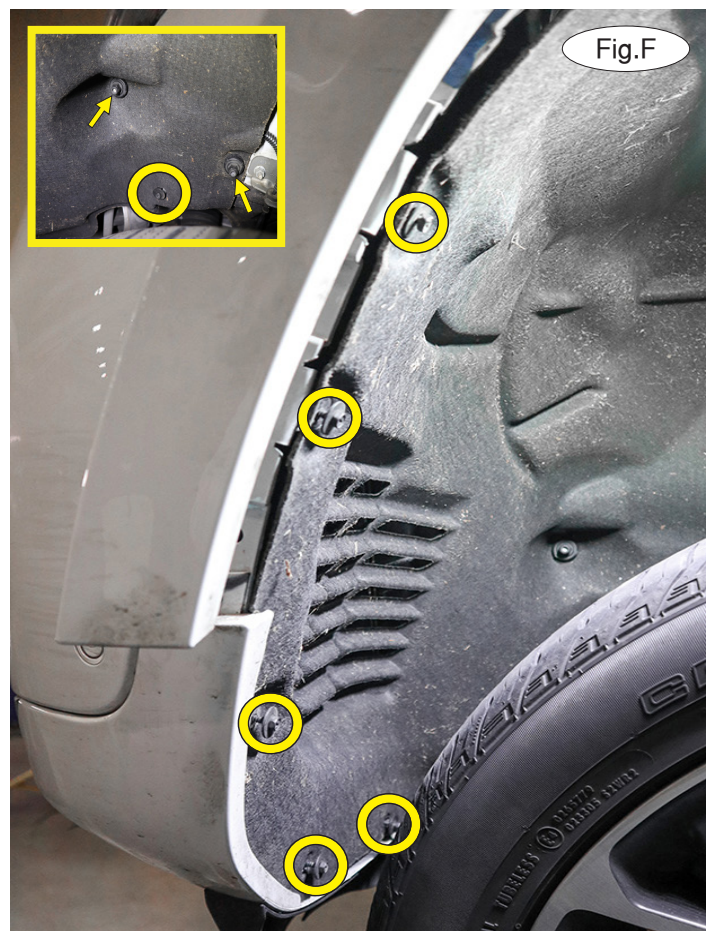
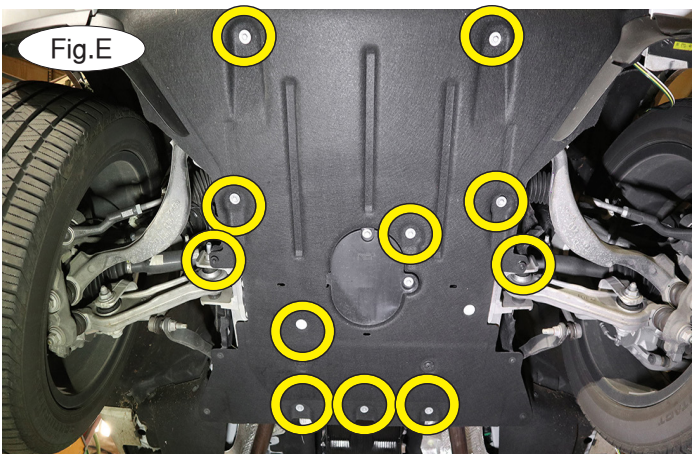

3. Remove nine 8mm bolts and two 10mm bolts attaching the splash shield to the frame (Fig.E). Let the splash shield hang down for now.

4. On each side, remove six 8mm bolts (Fig.F and Fig.F, inset – circles) and two 10mm plastic nuts (Fig.F, inset – arrows) attaching the fender liner to the subframe.



BASEPLATE KIT INSTALLATION INSTRUCTIONS

KIT# 521464-4

02/29/24
KS

ROADMASTER, Inc. 6110 NE 127th Ave. Vancouver, WA 98682 360-896-0407 fax 360-735-9300 www.roadmasterinc.com

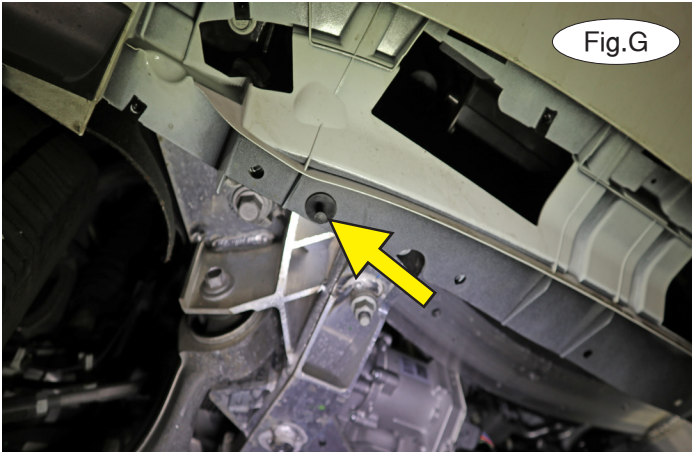

5. On each side, remove one plastic fastener attaching the bottom of the fascia to the frame (Fig.G).
6. On each side, peel back the fender liner and unplug any wiring harnesses in the indicated area (Fig.H – driver's side). *Note: If the vehicle has a front camera washer, you will need to cap and secure that line on the passenger side as well (Fig.I).*



7. On each side, pull out on the fender trim piece and release the arrowhead clips. Release the clips until you reach the rear arch (Fig.J) and then use a soft rag to prop it away from the vehicle. This allows you access to one 10mm bolt attaching the corner of the fascia to the fender. Remove that bolt (Fig.K).

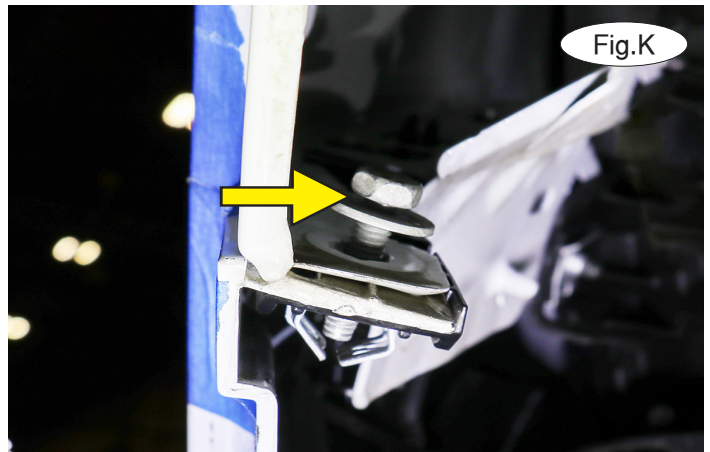



BASEPLATE KIT INSTALLATION INSTRUCTIONS

KIT# 521464-4

02/29/24
KS

ROADMASTER, Inc. 6110 NE 127th Ave. Vancouver, WA 98682 360-896-0407 fax 360-735-9300 www.roadmasterinc.com



Fig.L



Fig.M

8. With a second person to assist, pull up on the top of the fascia to clear the bump stops (Fig.L) and then out on the seam of the fascia to remove it (Fig.M).

9. On the passenger side, remove one plastic fastener attaching the ambient temperature sensor to the air dam (Fig.N). Let it hang down for now.

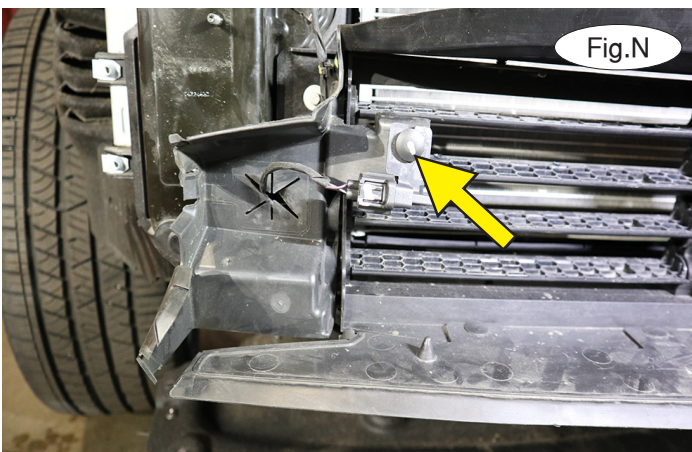

Fig.N

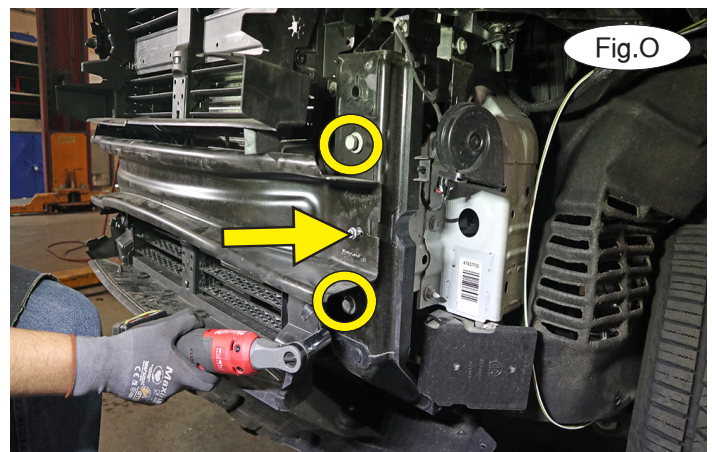

Fig.O

10. On each side, remove two 16mm bolts (Fig.O – circles) and one 10mm nut attaching the bumper core to the frame (Fig.O – arrow). Pull out to remove the bumper core. It will not be replaced. Retain the bolts for replacement in a future step.

11. Remove four plastic fasteners attaching the lower shutter housing cover to the housing (Fig.P – circles) and on each side, two fasteners on the lower outside edges of the housing cover (Fig.P – arrows show approximate location). Set the cover aside. It will not be replaced.

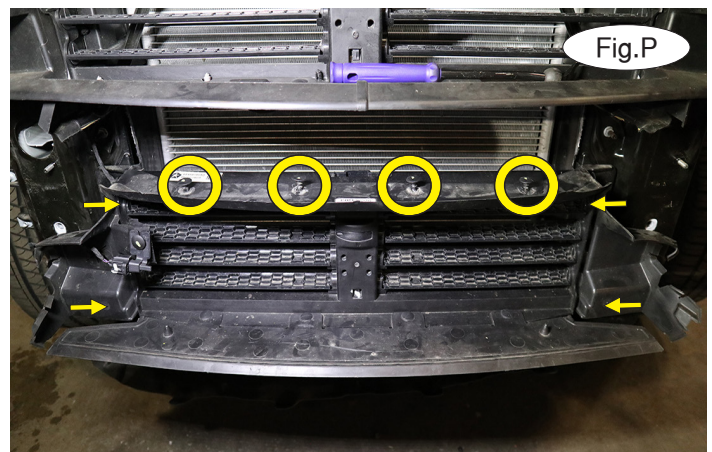

Fig.P



BASEPLATE KIT INSTALLATION INSTRUCTIONS

KIT# 521464-4

02/29/24
KS

ROADMASTER, Inc. 6110 NE 127th Ave. Vancouver, WA 98682 360-896-0407 fax 360-735-9300 www.roadmasterinc.com



12. On each side, trim the air deflector as shown to allow clearance for the main receiver brace (Fig.Q).

13. On each side, place a $\frac{1}{2}$ " lock washer, $\frac{3}{16}$ " x $2\frac{1}{4}$ " round plate washer and Loctite over a $\frac{1}{2}$ " x $6\frac{1}{2}$ " bolt. Bolt through the back of the vertical body mount and into the rear end of the $6\text{-}5/16$ " tube spacer (Fig.R).

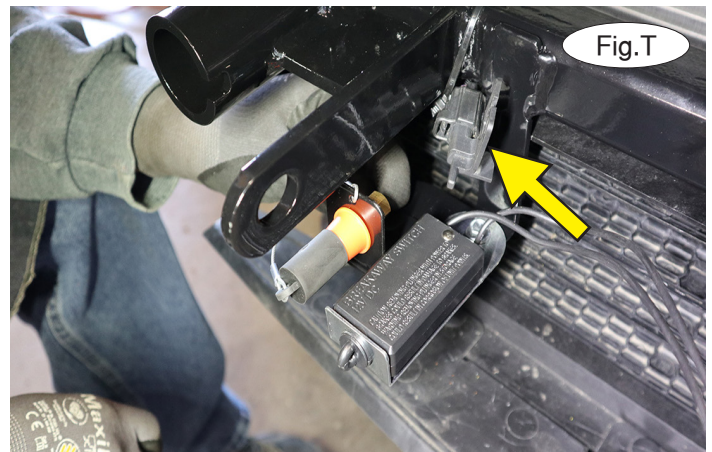

14. On each side, prepare one $\frac{1}{2}$ " x $1\frac{1}{2}$ " bolt with a $\frac{1}{2}$ " lock washer, $\frac{1}{2}$ " flat washer and Loctite. Then, with the help of a second person, lift the baseplate into place over the end of the tube spacer and use your prepared bolt to secure it. On each side, place Loctite on the factory 16mm bolts and the one 10mm nut that you removed in step 10. Reinstall them, and finger tighten (Fig.S).

15. Use two zip ties to secure the ambient temperature sensor to the crossbar of the baseplate (Fig.T). If you're using a braking system, there is a provided mount on the passenger side for your breakaway switch and your air brake fitting (Fig.T).

16. Apply upward pressure on the baseplate and torque the factory bolts and then the front and rear two $\frac{1}{2}$ " tube spacer bolts on each side. Place Loctite on the two 10mm factory nuts and replace them. Tighten the bolts.

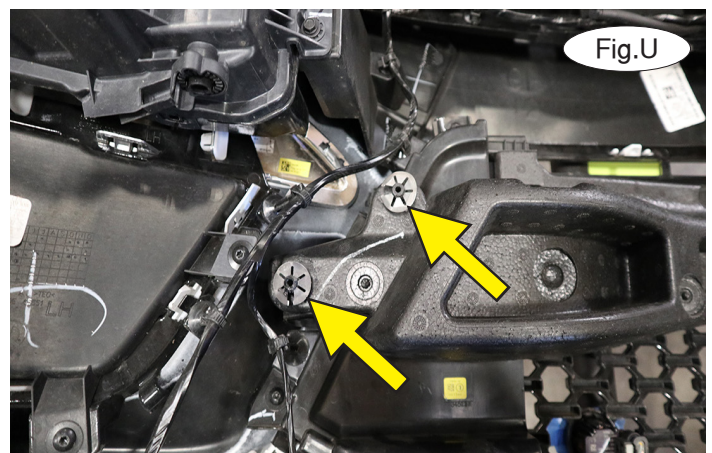

17. On each side, remove two star clips attaching the foam shock absorption pad to the back of the fascia (Fig.U). Remove it. It will not be replaced.



BASEPLATE KIT INSTALLATION INSTRUCTIONS

KIT# 521464-4

02/29/24
KS

ROADMASTER, Inc. 6110 NE 127th Ave. Vancouver, WA 98682 360-896-0407 fax 360-735-9300 www.roadmasterinc.com

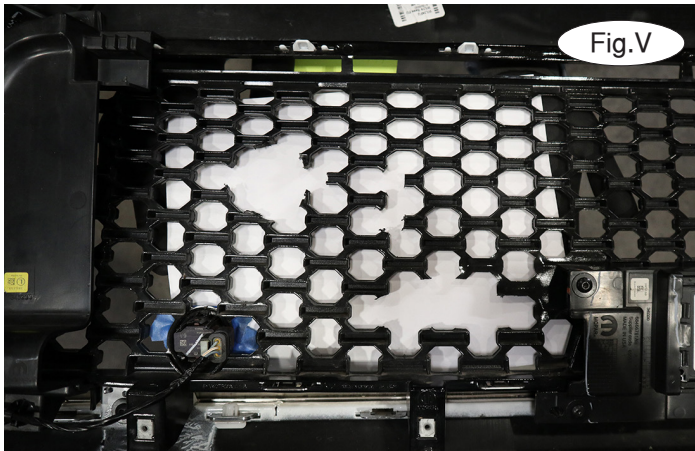

18. Hold the fascia in place over the baseplate. Mark it and trim as required to allow clearance for the receivers and safety cable tabs and wiring plug rods and the Brakeaway (Fig.V).

19. Reinstall the fascia, reversing steps 1 through 8. Figure W shows the completed installation.

20. On each side, insert the removable front arm into the front receiver 90 degrees from its final towing position, depressing the spring-loaded pin against the receiver. Twist back 90 degrees until the spring-loaded pin snaps into place in the notch on the receiver, locking the arm into place in its final towing position. **Please note: It is the owner's responsibility to ensure the locking of the pins before towing. Otherwise, failure of the towing system will result.**

21. Install the tow bar to the baseplate according to the manufacturer's instructions.

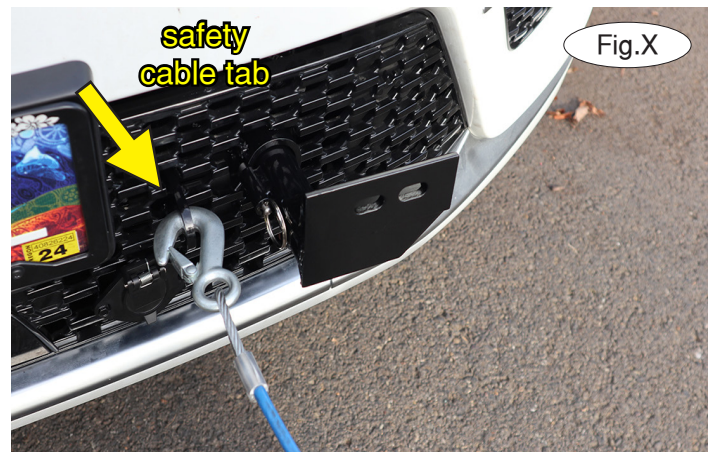

IMPORTANT!

Safety cables are required by law. When towing, connect safety cables to the safety cable tabs illustrated on the first page and in Figure X. Make certain there is adequate slack in the cables to allow a full turning radius; otherwise, damage will result. If necessary, longer cables or cable extensions are availableX



BASEPLATE KIT INSTALLATION INSTRUCTIONS

KIT# 521464-4

02/29/24
KS

ROADMASTER, Inc. 6110 NE 127th Ave. Vancouver, WA 98682 360-896-0407 fax 360-735-9300 www.roadmasterinc.com

Three options for attaching the wiring plug to the main receiver brace

For six-wire plugs: Use the two supplied 3/4" self-tapping screws to attach the electrical plug directly to the rods on the front of the main receiver brace.

For four-wire round plugs: Attach to the plug mounting plate and then use the two supplied 3/4" self-tapping screws to attach the mounting plate to the rods on the front of the main receiver brace.

For four-wire flat plugs: Place the plug through the mounting plug plate, and then secure it using the supplied zip tie on the front of the plug (Fig.Y). Use the two supplied 3/4" self-tapping screws to attach the mounting plate to the rods on the front of the main receiver brace.

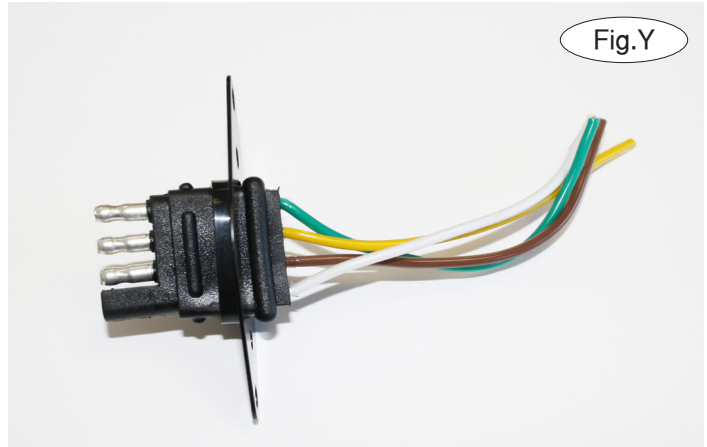

Fig.Y

BOLT TORQUE REQUIREMENTS

Note: The torque values represented below are intended as general guidelines. Torque requirements for specific applications may vary. Roadmaster does not warrant this information to be accurate for all applications and disclaims all liability for any claims or damages which may result from its use.

STANDARD BOLTS

Thread Size	Grade	Torque
5/16-18	5	13 ft./lb.
3/8-16	5	23 ft./lb.
7/16-14	5	37 ft./lb.
1/2-13	5	57 ft./lb.
5/8-11	5	112 ft./lb.

METRIC BOLTS

Thread Size	Grade	Torque
6mm-1.0	8.8	6 ft./lb.
8mm-1.0	8.8	18 ft./lb.
8mm-1.25	8.8	16 ft./lb.
10mm-1.25	8.8	36 ft./lb.
10mm-1.5	8.8	31 ft./lb.

METRIC BOLTS

Thread Size	Grade	Torque
12mm-1.25	8.8	64 ft./lb.
12mm-1.5	8.8	60 ft./lb.
12mm-1.75	8.8	55 ft./lb.
14mm-2.0	8.8	88 ft./lb.

All illustrations and specifications contained herein are based on the latest information available at the time of publication approval. ROADMASTER, INC. reserves the right to make changes at any time without notice in material, specification and models or to discontinue models.