



BASEPLATE KIT INSTALLATION INSTRUCTIONS

KIT# 521569-4

04/26/19
KS

ROADMASTER, Inc. 6110 NE 127th Ave. Vancouver, WA 98682 360-896-0407 fax 360-735-9300 www.roadmasterinc.com

ROADMASTER, INC.

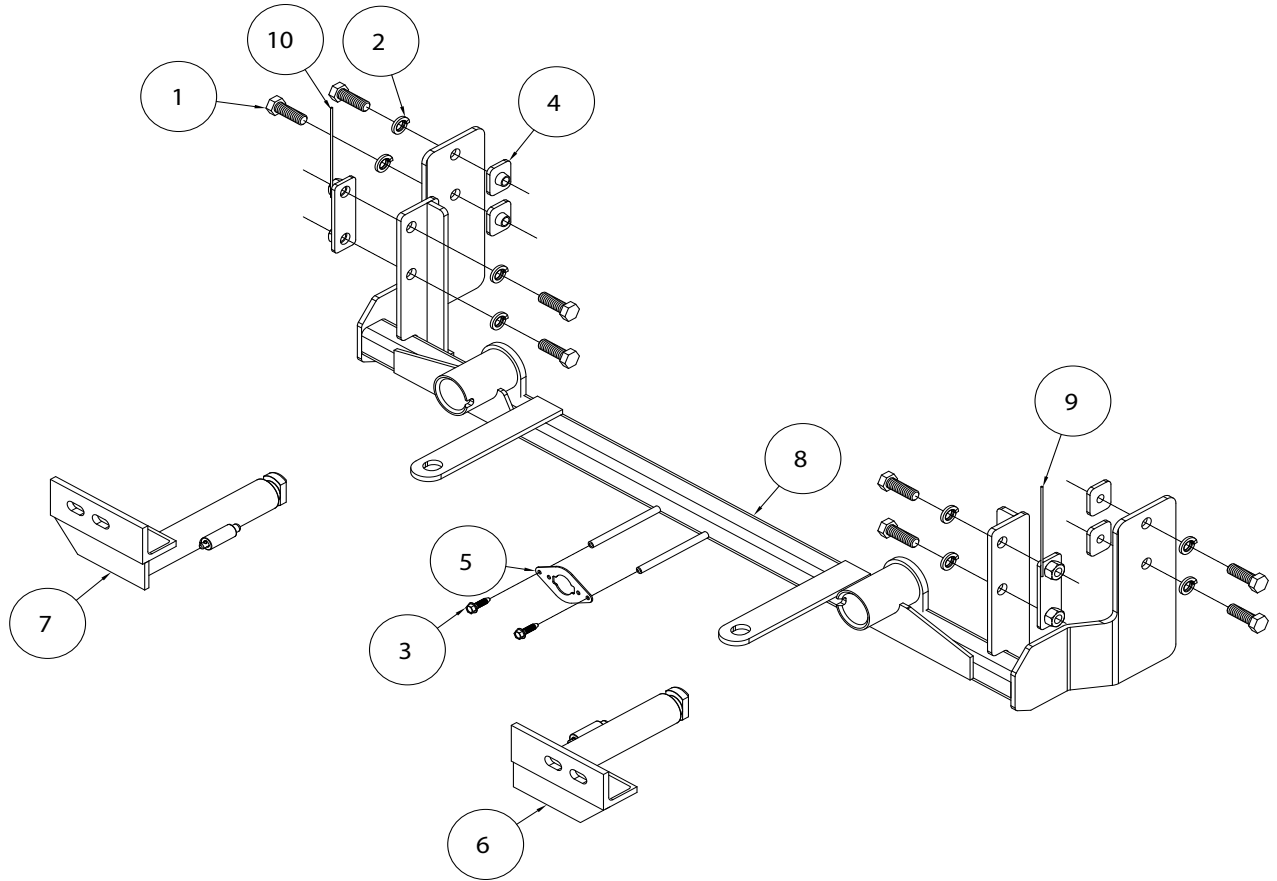

ITEM	QTY	NAME	PART #
1.....	8.....	1/2" x 1 1/2" BOLT.....	350095-00
2.....	8.....	1/2" LOCK WASHER.....	350309-00
3.....	2.....	#10 x 3/4" SELF DRILLING SCREW.....	350247-35
4.....	4.....	1 1/4" x 1 1/2" THREADED BACKING PLATE.....	A-003075
5.....	1.....	WIRE PLUG PLATE.....	A-003801
6.....	1.....	DRIVER SIDE ARM.....	C-002799
7.....	1.....	PASSENGER SIDE ARM.....	C-002800
8.....	1.....	MAIN RECEIVER.....	C-002801
9.....	1.....	DOUBLE WELD NUT W/5" ROD BACKING PLATE.....	C-002802
10.....	1.....	DOUBLE WELD NUT W/5" ROD BACKING PLATE.....	C-002803
11.....	1.....	ZIP TIE.....	300140-8



BASEPLATE KIT INSTALLATION INSTRUCTIONS

KIT# 521569-4

04/26/19
KS

ROADMASTER, Inc. 6110 NE 127th Ave. Vancouver, WA 98682 360-896-0407 fax 360-735-9300 www.roadmasterinc.com

This is one of our crossbar-style series baseplates, which allows the visible front portion to be easily removed from the front of the vehicle (Fig.A and Fig.B). The kit consists of a main receiver brace, two removable front braces and a hardware pack.

The main receiver brace mounts to the frame rails and the bumper core. The removable front braces install in the main receiver brace.

Before starting the installation, lay out the kit components in order, as they will be used. This will give you a visual idea of how the components work, and will also confirm that everything is present and accounted for.



Fig.A



Fig.B

IMPORTANT: All baseplates **must** be assembled with all the bolts left loose for final adjustment and positioning (before tightening) unless otherwise instructed. All bolts **must** be torqued for proper strength. If more than one bolt is used per fastening point, the diagram may only show one. Use flat washers over all slotted holes and lock washers on all fasteners.

WARNING

Failure to heed these warnings or follow the installation instructions may result in a voided warranty, loss of towed vehicle, personal injury or death.

- Do not weld or modify this baseplate or its components. Welding or modification will void the warranty.
- Do not use this document as a basis to design/fabricate a baseplate, as it may not show all parts or structural components.
- We strongly recommend professional installation.
- If the towed vehicle has been in an accident, it must be properly repaired before attaching the baseplate. Do not install the baseplate if any structural frame damage is found.
- The installer must use all bolts and parts supplied. If running changes were made by the vehicle manufacturer after this kit was designed, some bolts or other fasteners may no longer be the correct size. It is the installer's responsibility to verify this kit is securely fastened to the vehicle.
- Use Loctite® Red on all bolts used to secure this baseplate. Torque all bolts to the specifications found at the end of these instructions. Do not over-torque the bolts or failure may occur.
- The installer must inspect the baseplate to ensure adequate clearance, particularly around hoses, air conditioner lines, radiators, etc. or non-warranty failure may result.
- Roadmaster manufactures many styles of baseplates. If your baseplate has removable arms, they must be removed before driving the vehicle, unless the arms can be pinned or padlocked in place. If not secured, the arms could vibrate out.
- Some motorhome chassis have such a tight turning radius that you can damage your motorhome, towed vehicle, tow bar or baseplate while turning sharply. Before getting on the road, test your turning radius in an empty parking lot. Turning too sharply could

result in non-warranty damage to your towing system, motorhome and/or towed vehicle.

- Do not back up with the towed vehicle attached or non-warranty damage will occur to your towing system or vehicles.
- The safety cables must connect the towing vehicle to the towed vehicle frame to frame, with the cables crossed, with enough slack for sharp turns. See cable instructions for proper routing. Failure to do so will result in non-warranty damage and/or the loss of the towed vehicle.
- This kit is designed for use with ROADMASTER tow bars and ROADMASTER adapters only. Using this kit with other brands, without an approved ROADMASTER adapter, may result in non-warranty damage or injury.
- Receiver extensions and out-of-level towing situations of 3 inches or more. This can cause the system to swing much higher and lower, causing excessive strain on the tow bar, baseplate and frame. That can cause the towing system to fail, causing property damage, personal injury or even death. If you must use a receiver extension or drop hitch to tow, it will reduce your receiver's weight capacity by 1/3 to avoid damaging your system. Never use more than one extension and/or drop hitch, as this will void your warranty.
- Every 3,000 miles, the owner must inspect all mounting points for cracks or fatigue, and check the fasteners for proper torque, according to the bolt torque requirements chart on the last page of these instructions.
- The owner must follow the vehicle manufacturer's instructions to prepare the vehicle for towing. Failure to do so may cause severe damage to the vehicle.
- This baseplate is only warranted for the original installation. Installing a used baseplate on another vehicle is not recommended and will void the warranty.



BASEPLATE KIT INSTALLATION INSTRUCTIONS

KIT# 521569-4

04/26/19
KS

ROADMASTER, Inc. 6110 NE 127th Ave. Vancouver, WA 98682 360-896-0407 fax 360-735-9300 www.roadmasterinc.com

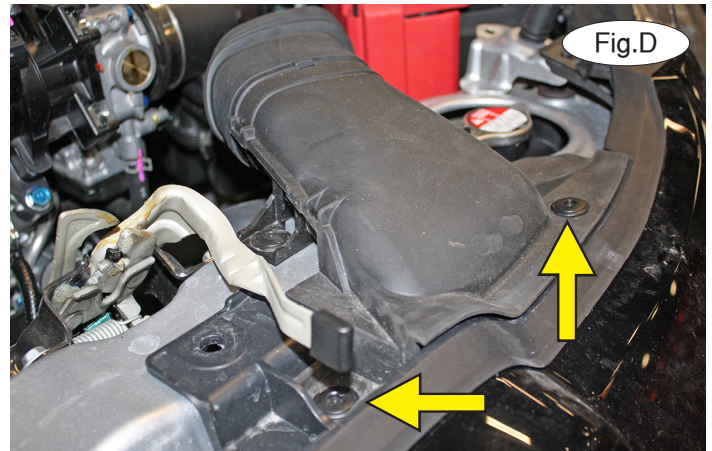
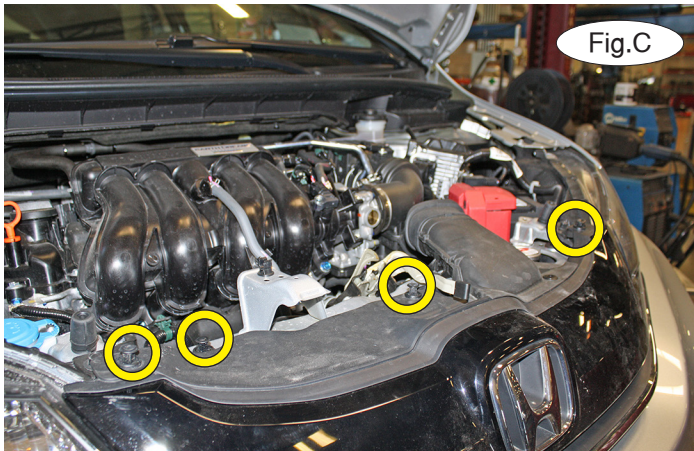

1. **Important:** please use all supplied bolts and parts and read all instructions carefully before beginning this installation. The majority of questions you may have can be answered within the text, and proper installation will ensure safe and secure travel. Now, begin the installation. Remove four plastic fasteners attaching the radiator cover to the top of the fascia and core support (Fig.C).

2. Remove two pin fasteners attaching the intake ducting to the fascia (Fig.D).

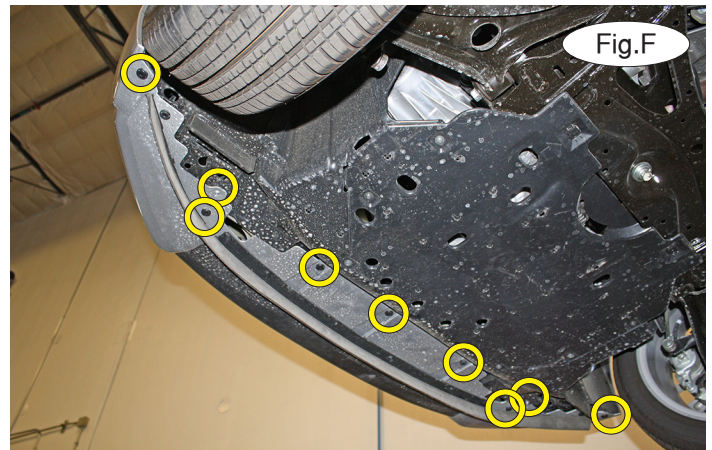
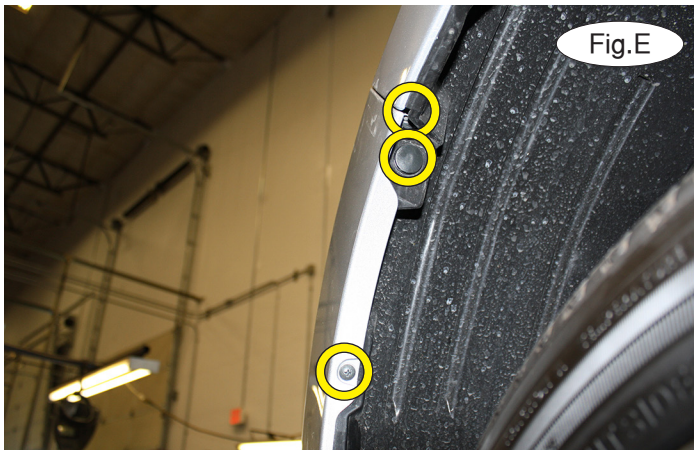

3. On each side, remove two Phillips screws and one plastic fastener attaching the fascia to the fender liner and fender (Fig.E).

4. Remove seven plastic fasteners and two screws attaching the bottom of the fascia to the splash shielding (Fig.F).

5. Disconnect the fog lights, if the vehicle is so equipped. Pull out and forward on the corners of the fascia to release the locking strip (Fig.G).





BASEPLATE KIT INSTALLATION INSTRUCTIONS

KIT# 521569-4

04/26/19
KS

ROADMASTER, Inc. 6110 NE 127th Ave. Vancouver, WA 98682 360-896-0407 fax 360-735-9300 www.roadmasterinc.com

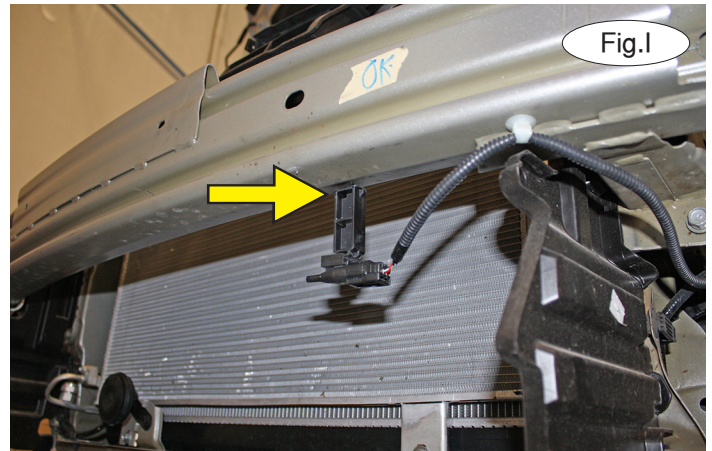

6. On each side, disconnect two clips and one plastic fastener attaching the air dam to the bumper core (Fig.H). *Note:* they will not be replaced. Retain the air dams and their fasteners for replacement in case the bracket is ever removed from the vehicle. Then, disconnect the plastic fastener attaching the ambient temperature sensor to the bumper core (Fig.I).



7. On the passenger side, remove one plastic fastener attaching the bottle neck of the washer bottle to the core support (Fig.J). Twist the bottle neck and pull up on it to remove it.

8. Remove two 10mm (head) bolts attaching the washer bottle to the frame. Then, reattach the bottle neck and securely hang the assembly out of the way for now, or use a stand to support it (Fig.K).

9. Using a jackstand or a second person, place the main receiver brace under the bumper core and around the frame (Fig.L).





BASEPLATE KIT INSTALLATION INSTRUCTIONS

KIT# 521569-4

04/26/19
KS

ROADMASTER, Inc. 6110 NE 127th Ave. Vancouver, WA 98682 360-896-0407 fax 360-735-9300 www.roadmasterinc.com

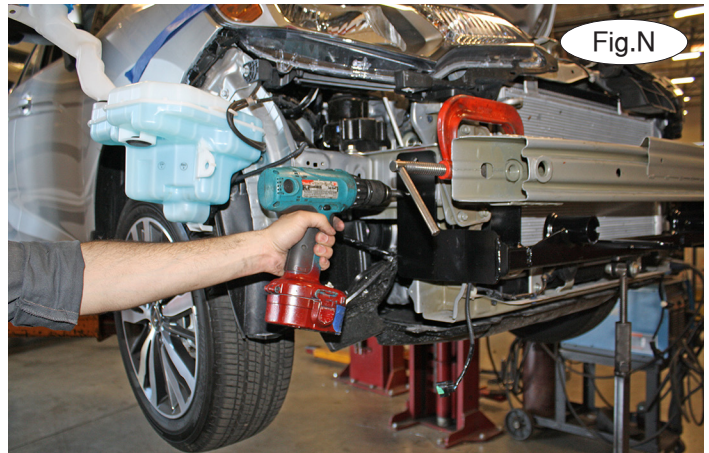

10. On each side, center the holes of the innermost mounts of the main receiver brace over the existing holes to the inside of the bumper core (Fig.M). Then, clamp the main receiver brace to the bumper core (Fig.N).

11. Ensure that the main receiver brace is square and level and then, on each side, use the rear mount holes as templates and use a $\frac{1}{2}$ " drill to drill through the outside layer of the frame rail (Fig.N).

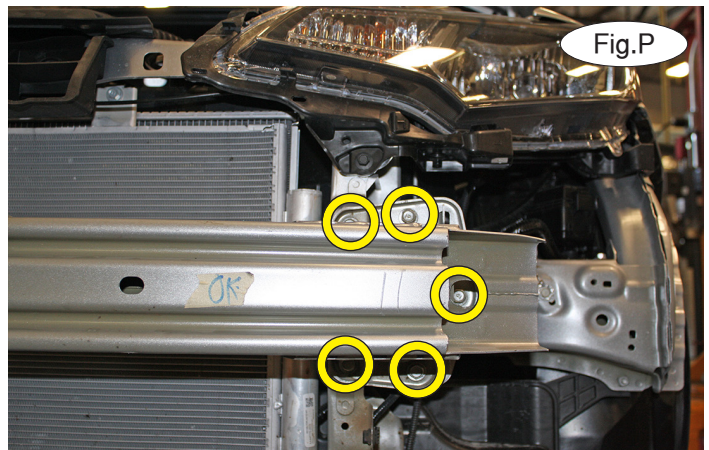

12. Now, temporarily remove the main receiver brace and set it aside. Then, ream or drill out the holes from step 10 so they are $\frac{1}{2}$ " (Fig.O).

13. On each side, remove five 12mm (head) bolts attaching the bumper core to the bumper core mounts (Fig.P) and temporarily remove the bumper core.

14. Replace the main receiver brace and, on each side, using the two supplied $\frac{1}{2}$ " x $1\frac{1}{2}$ " bolts and $\frac{1}{2}$ " lock washers, bolt through the main receiver brace and the holes you drilled in step 11, through the bumper core, and finish with $\frac{3}{16}$ " x $1\frac{1}{4}$ " x $1\frac{1}{2}$ " threaded backing plates (Fig.Q). Finger tighten only for now. *Note:* ensure proper alignment, as the bolts will receive Loctite® Red and will be torqued at the end of these instructions.





BASEPLATE KIT INSTALLATION INSTRUCTIONS

KIT# 521569-4

04/26/19
KS

ROADMASTER, Inc. 6110 NE 127th Ave. Vancouver, WA 98682 360-896-0407 fax 360-735-9300 www.roadmasterinc.com



15. Place the bumper core on a work bench for now. On each side, place the double weld nut backing plate with rod inside the bumper core (Fig.R) and pull the rod through the hole as shown in Figure S. *Note:* there is a right and a left backing plate with rod. Refer to the drawing on page 1 to ensure that you are using the correct one for each side, which may require slight bending of the rod to achieve the correct fit. The appropriate one will allow the plate to sit flush over the holes you enlarged in step 12. If you find it too challenging to achieve the fit, you can also break off the rod and tape the

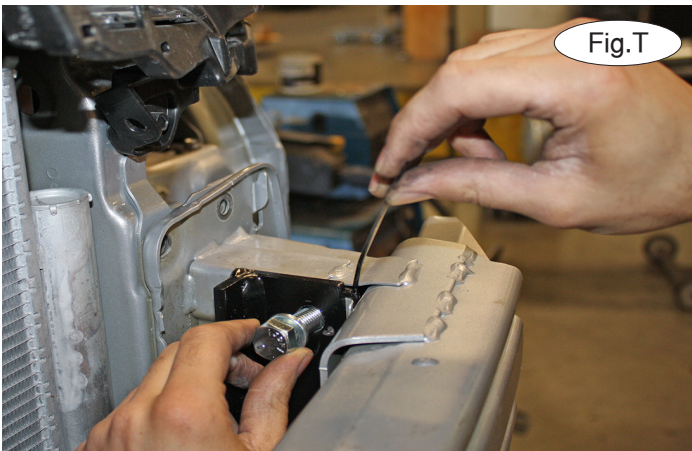

double weld nut backing plate into place inside the bumper core so it sits flush.

16. Reinstall the bumper core by replacing it and the five 12mm (head) bolts on each side. Then, on each side, using the two supplied $\frac{1}{2}$ " x $1\frac{1}{2}$ " bolts and $\frac{1}{2}$ " lock washers, bolt through the inside upper mounting points and into the double weld nut backing plates with rod that you installed in the previous step (Fig.T).

17. Tighten all bolts to the bolt torque requirements found at the end of these instructions. *Note:* use Loctite® Red on all nuts and bolts. Use a pair of pliers to break the wires off the plates, or bend them out of the way.

18. Zip tie the ambient temperature sensor to the main receiver brace and reinstall the washer bottle by reversing steps 7 and 8.

19. Reinstall the fascia, reversing steps 1 through 5.





BASEPLATE KIT INSTALLATION INSTRUCTIONS

KIT# 521569-4

04/26/19
KS

ROADMASTER, Inc. 6110 NE 127th Ave. Vancouver, WA 98682 360-896-0407 fax 360-735-9300 www.roadmasterinc.com

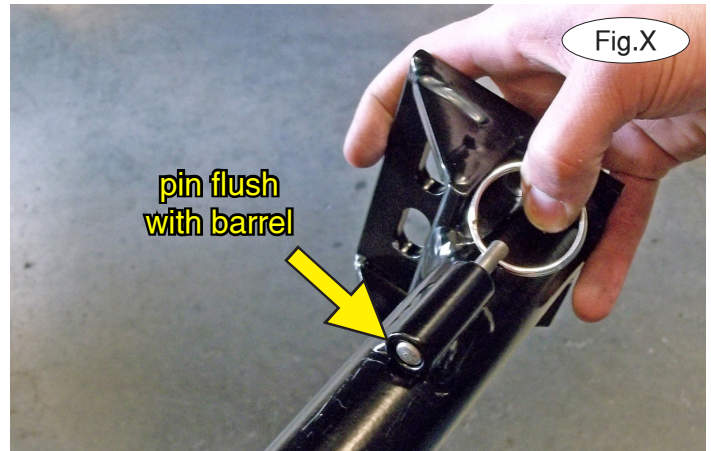

21. **Note: the following four images are for illustration purposes only, as your specific application may be slightly different.**

The spring-loaded pin on the removable arm snaps into a notch on the receiver, locking the removable arm into its final towing position. Before inserting each arm into the receiver, verify that the spring is working by ensuring that the spring-loaded pin moves easily back and forth within the barrel when pulled and that it can be pulled flush with the face of the barrel (Fig.W and Fig.X).

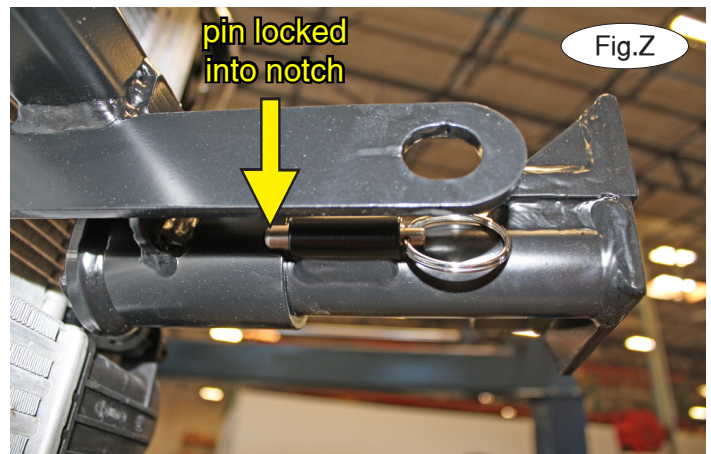
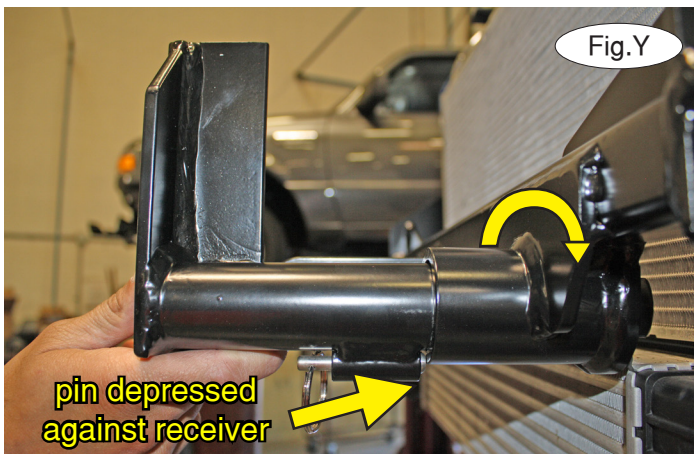

22. On each side, insert the removable front bracket arm into the front receiver 90 degrees from its final towing position, depressing the spring-loaded pin against the receiver (Fig.Y). Now, twist back 90 degrees until the spring-loaded pin snaps into place in the notch on the receiver, locking the arm into place in its final towing position (Fig.Z).

Please note: it is the owner's responsibility to ensure the locking of the pins before towing. Otherwise, failure of the towing system will result.

23. Install the tow bar to the mounting bracket according to the manufacturer's instructions.



BASEPLATE KIT INSTALLATION INSTRUCTIONS

KIT# 521569-4

04/26/19
KS

ROADMASTER, Inc. 6110 NE 127th Ave. Vancouver, WA 98682 360-896-0407 fax 360-735-9300 www.roadmasterinc.com

IMPORTANT!

Safety cables are required by law. When towing, connect safety cables to the safety cable tabs illustrated in Figure AA. Make certain there is adequate slack in the cables to allow a full turning radius; otherwise, damage will result. If necessary, longer cables or cable extensions are available.

Note: if the bracket is so equipped, the holes in the alignment tabs which are welded to the arms and main receivers are for padlocks only. Under no circumstances should you bolt the alignment tabs together. Bolting the alignment tabs together may result in non-warranty damage to the bracket.



Three options for attaching the wiring plug to the main receiver brace

For six-wire plugs: use the two supplied 3/4" self-tapping screws to attach the electrical plug directly to the rods on the front of the main receiver brace.

For four-wire round plugs: attach to the plug mounting plate and then use the two supplied 3/4" self-tapping screws to attach the mounting plate to the rods on the front of the main receiver brace.

For four-wire flat plugs: place the plug through the mounting plug plate, and then secure it using the supplied zip tie on the front of the plug (Fig.BB). Use the two supplied 3/4" self-tapping screws to attach the mounting plate to the rods on the front of the main receiver brace.

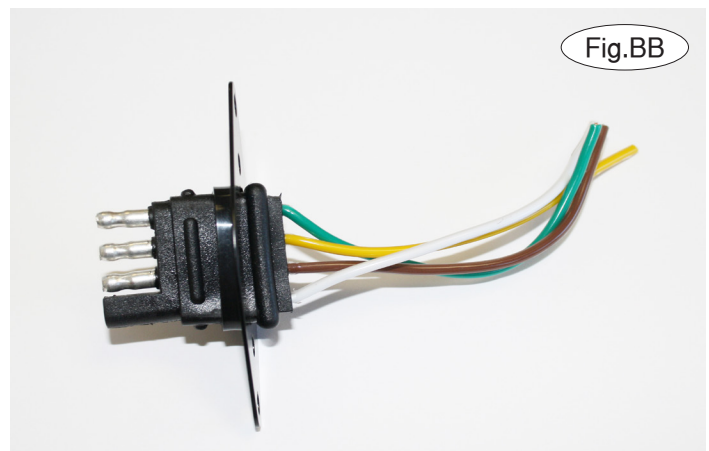

BOLT TORQUE REQUIREMENTS

Note: The torque values represented below are intended as general guidelines. Torque requirements for specific applications may vary. Roadmaster does not warrant this information to be accurate for all applications and disclaims all liability for any claims or damages which may result from its use.

STANDARD BOLTS

Thread Size	Grade	Torque
5/16.....	5.....	13 ft./lb.
3/8.....	5.....	23 ft./lb.
7/16.....	5.....	37 ft./lb.
1/2.....	5.....	56 ft./lb.
5/8.....	5.....	150 ft./lb.

METRIC BOLTS

Thread Size	Grade	Plated / Unplated
8mm-1.0	8.8	20 ft./lb. 18 ft./lb.
8mm-1.25	8.8	19 ft./lb. 18 ft./lb.
10mm-1.25	8.8	38 ft./lb. 36 ft./lb.
10mm-1.5	8.8	37 ft./lb. 35 ft./lb.

METRIC BOLTS

Thread Size	Grade	Plated / Unplated
12mm-1.25	8.8	70 ft./lb. 65 ft./lb.
12mm-1.5	8.8	66 ft./lb. 61 ft./lb.
12mm-1.75	8.8	65 ft./lb. 60 ft./lb.
14mm-2.0	8.8	104 ft./lb. 97 ft./lb.

All illustrations and specifications contained herein are based on the latest information available at the time of publication approval. ROADMASTER, INC. reserves the right to make changes at any time without notice in material, specification and models or to discontinue models.