



BASEPLATE KIT INSTALLATION INSTRUCTIONS

KIT# 521644-5

06/03/20
KS

ROADMASTER, Inc. 6110 NE 127th Ave. Vancouver, WA 98682 360-896-0407 fax 360-735-9300 www.roadmasterinc.com

Important
Note: this bracket will not accommodate the Guardian rock shield, some models of the Tow Defender, Stowaway or the StowMaster and StowMaster All Terrain tow bars.

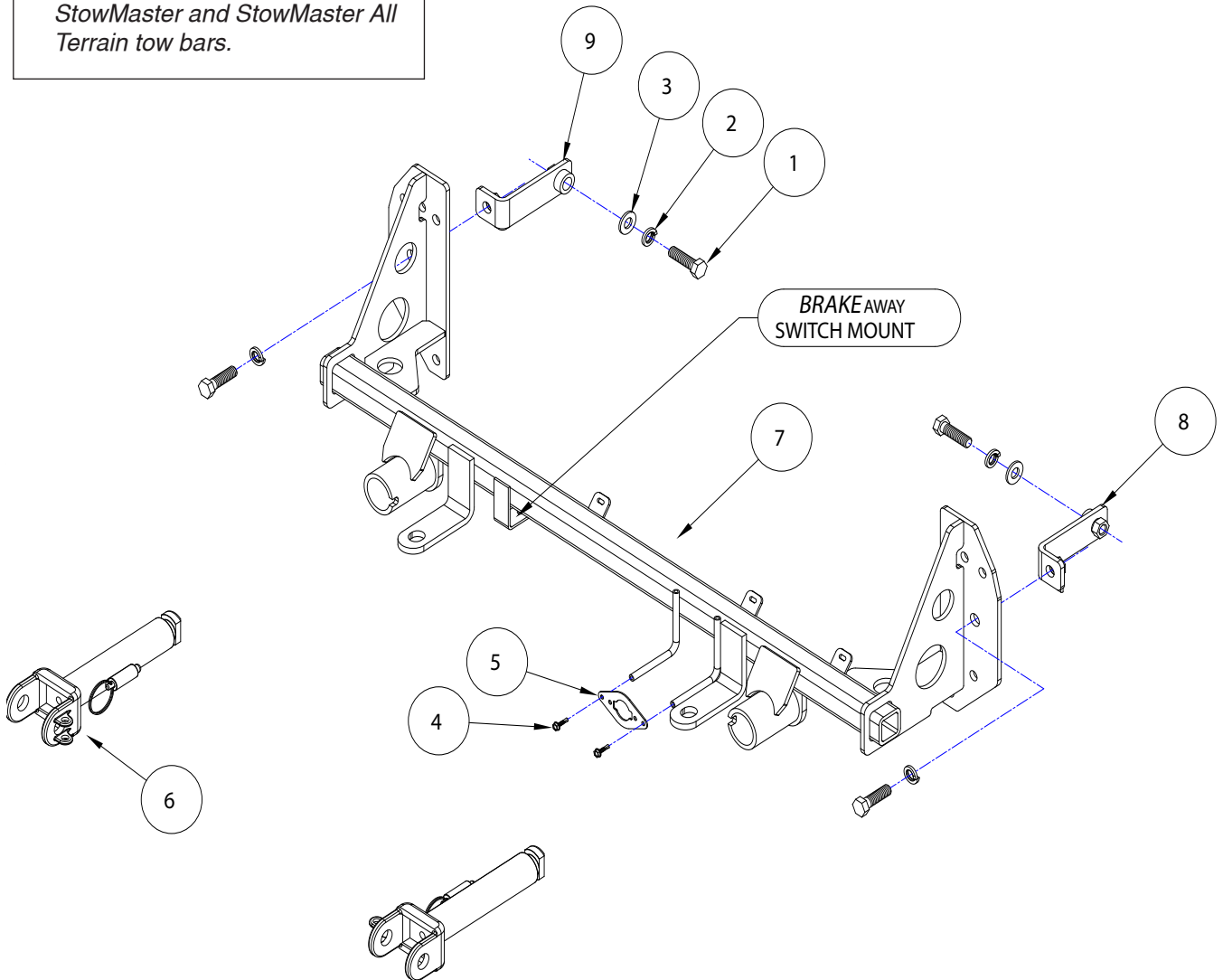

ITEM	QTY	NAME	MATERIAL
1	4	1/2" x 1 3/4" BOLT	350096-00
2	4	1/2" LOCK WASHER	350309-00
3	2	1/2" SAE FLAT WASHER	350308-20
4	2	#10 x 3/4" SELF DRILLING SCREW	350247-35
5	1	WIRE PLUG PLATE	A-003801
6	1	ARM	C-002383
7	1	RECEIVER BRACE	C-003524
8	1	DRIVER SIDE REAR BRACKET	C-003525
9	1	PASSENGER SIDE REAR BRACKET	C-003526



BASEPLATE KIT INSTALLATION INSTRUCTIONS

KIT# 521644-5

06/03/20
KS

ROADMASTER, Inc. 6110 NE 127th Ave. Vancouver, WA 98682 360-896-0407 fax 360-735-9300 www.roadmasterinc.com

This is one of our direct-connect series baseplate kits, which allows the visible front portion to be easily removed from the front of the vehicle (Fig.A and Fig.B). The kit consists of a main receiver brace, two rear braces, two removable front braces, and a hardware pack.

The rear braces mount to the bumper core mounts. The main receiver brace attaches to the rear braces, and the removable front braces install in the main receiver brace.

Before starting the installation, lay out the kit components in order, as they will be used. This will give you a visual idea of how the components work, and will also confirm that everything is present and accounted for.



IMPORTANT: All baseplates **must** be assembled with all the bolts left loose for final adjustment and positioning (before tightening) unless otherwise instructed. All bolts **must** be torqued for proper strength. If more than one bolt is used per fastening point, the diagram may only show one. Use flat washers over all slotted holes and lock washers on all fasteners.

WARNING

Failure to heed these warnings or follow the installation instructions may result in a voided warranty, loss of towed vehicle, personal injury or death.

- Do not weld or modify this baseplate or its components. Welding or modification will void the warranty.
- Do not use this document as a basis to design/fabricate a baseplate, as it may not show all parts or structural components.
- We strongly recommend professional installation.
- If the towed vehicle has been in an accident, it must be properly repaired before attaching the baseplate. Do not install the baseplate if any structural frame damage is found.
- The installer must use all bolts and parts supplied. If running changes were made by the vehicle manufacturer after this kit was designed, some bolts or other fasteners may no longer be the correct size. It is the installer's responsibility to verify this kit is securely fastened to the vehicle.
- Use Loctite® Red on all bolts used to secure this baseplate. Torque all bolts to the specifications found at the end of these instructions. Do not over-torque the bolts or failure may occur.
- The installer must inspect the baseplate to ensure adequate clearance, particularly around hoses, air conditioner lines, radiators, etc. or non-warranty failure may result.
- Roadmaster manufactures many styles of baseplates. If your baseplate has removable arms, they must be removed before driving the vehicle, unless the arms can be pinned or padlocked in place. If not secured, the arms could vibrate out.
- Some motorhome chassis have such a tight turning radius that you can damage your motorhome, towed vehicle, tow bar or baseplate while turning sharply. Before getting on the road, test your turning radius in an empty parking lot. Turning too sharply could result in non-warranty damage to your towing system, motorhome and/or towed vehicle.
- Do not back up with the towed vehicle attached or non-warranty damage will occur to your towing system or vehicles.
- The safety cables must connect the towing vehicle to the towed vehicle frame to frame, with the cables crossed, with enough slack for sharp turns. See cable instructions for proper routing. Failure to do so will result in non-warranty damage and/or the loss of the towed vehicle.
- This kit is designed for use with ROADMASTER tow bars and ROADMASTER adapters only. Using this kit with other brands, without an approved ROADMASTER adapter, may result in non-warranty damage or injury.
- Receiver extensions and out-of-level towing situations of 3 inches or more. This can cause the system to swing much higher and lower, causing excessive strain on the tow bar, baseplate and frame. That can cause the towing system to fail, causing property damage, personal injury or even death. If you must use a receiver extension or drop hitch to tow, it will reduce your receiver's weight capacity by 1/3 to avoid damaging your system. Never use more than one extension and/or drop hitch, as this will void your warranty.
- Every 3,000 miles, the owner must inspect all mounting points for cracks or fatigue, and check the fasteners for proper torque, according to the bolt torque requirements chart on the last page of these instructions.
- The owner must follow the vehicle manufacturer's instructions to prepare the vehicle for towing. Failure to do so may cause severe damage to the vehicle.
- This baseplate is only warranted for the original installation. Installing a used baseplate on another vehicle is not recommended and will void the warranty.



BASEPLATE KIT INSTALLATION INSTRUCTIONS

KIT# 521644-5

06/03/20
KS

ROADMASTER, Inc. 6110 NE 127th Ave. Vancouver, WA 98682 360-896-0407 fax 360-735-9300 www.roadmasterinc.com

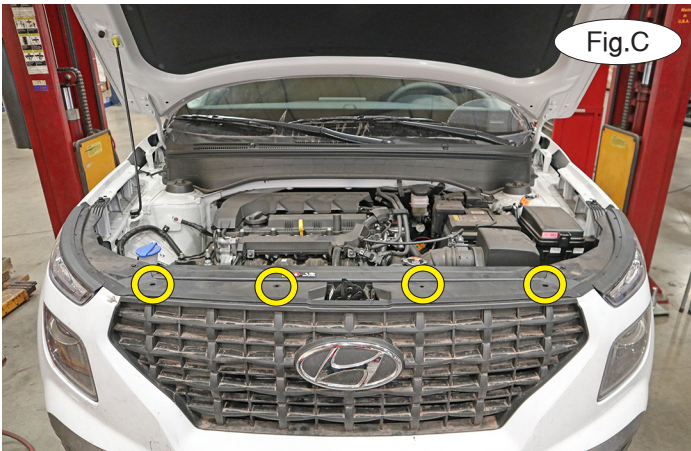

1. **Important:** please use all supplied bolts and parts and read all instructions carefully before beginning this installation. The majority of questions you may have can be answered within the text, and proper installation will ensure safe and secure travel. Now, begin the installation by removing four plastic fasteners attaching the top of fascia to the radiator support (Fig.C).

2. On each side, remove three plastic fasteners and one 8mm screw attaching the wheel well liner to the fascia (Fig.D).



3. On each side, remove two 10mm bolts and one plastic fastener attaching the splash shield to the bottom of the fascia (Fig.E).

4. On each side, pull out on the corner of the fascia to release the locking strip (Fig.F). **Note: Do not turn the vehicle on at any point once the fascia is removed, as it may trigger a check engine light on the dash.**

5. On the driver's side only, carefully remove the ambient temperature sensor from its mount (Fig.G – left), turn it 180 degrees and remount it on the back of the same mount (Fig.G – right).

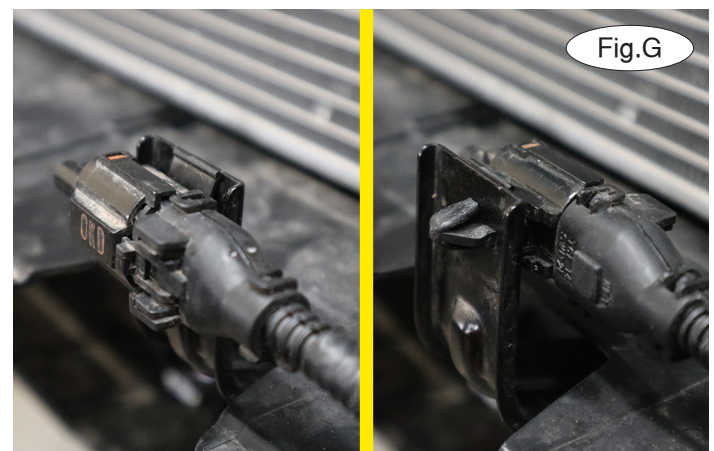



BASEPLATE KIT INSTALLATION INSTRUCTIONS

KIT# 521644-5

06/03/20
KS

ROADMASTER, Inc. 6110 NE 127th Ave. Vancouver, WA 98682 360-896-0407 fax 360-735-9300 www.roadmasterinc.com

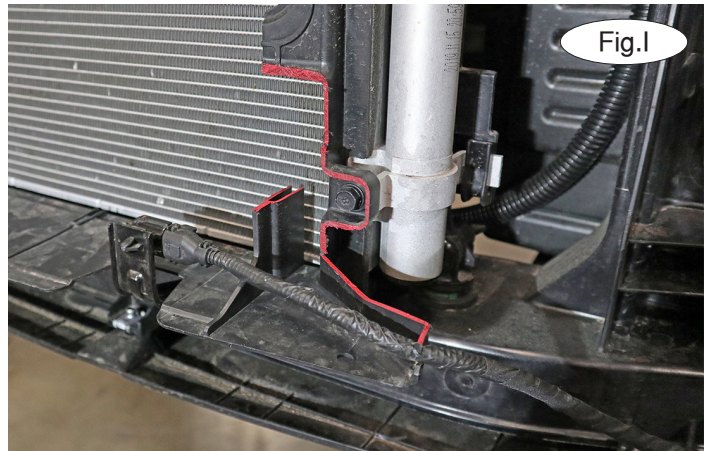
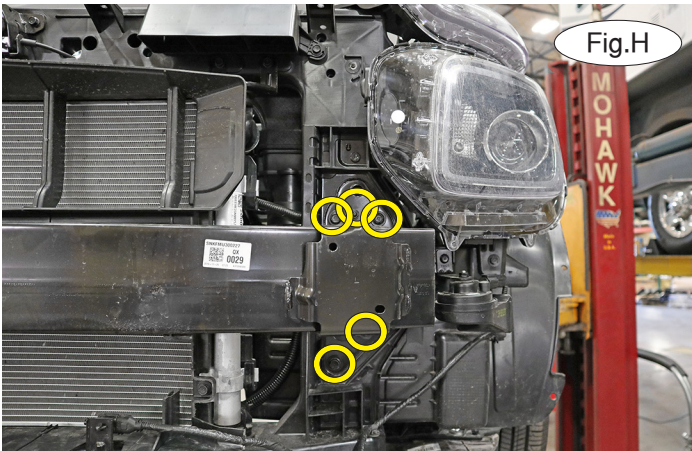

6. On each side, remove four 12mm bolts and one 10mm nut attaching the bumper core to the frame (Fig.H). The bumper will not be replaced. *Note:* Retain the bumper core in case the baseplate is ever removed from the vehicle.

7. Trim the lower part of the air dam on each side, using the red lines in Figure I and Figure J as a reference.

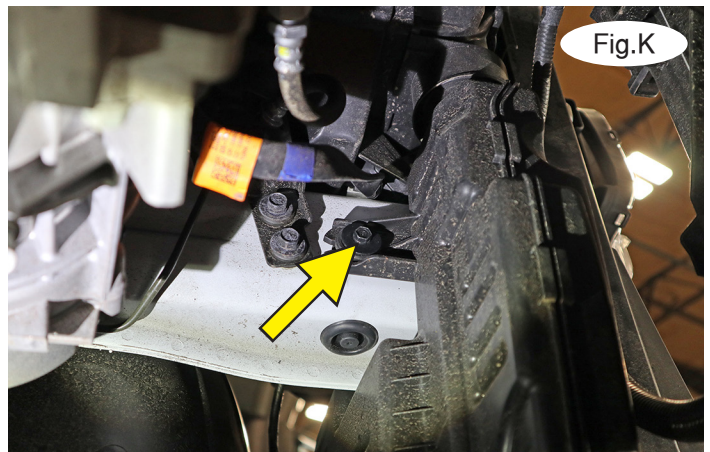
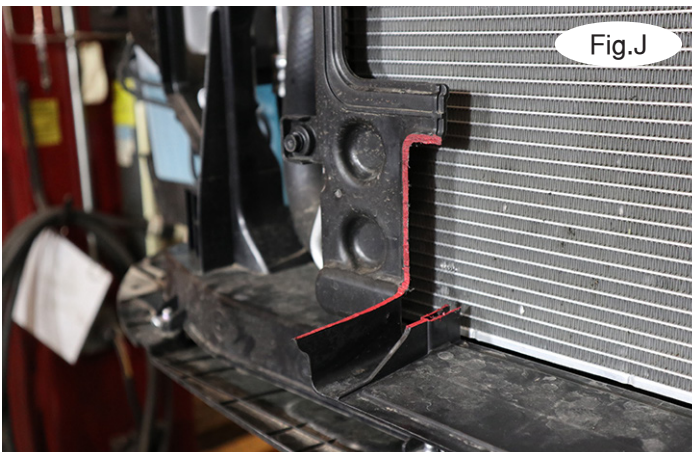

8. On the driver's side only, remove three 10mm bolts attaching the air box to the frame (Fig.K and L). Release one retaining clip attaching a wiring harness to the air box (Fig.M). Pull straight down and toward the outside of the vehicle to remove the air box.

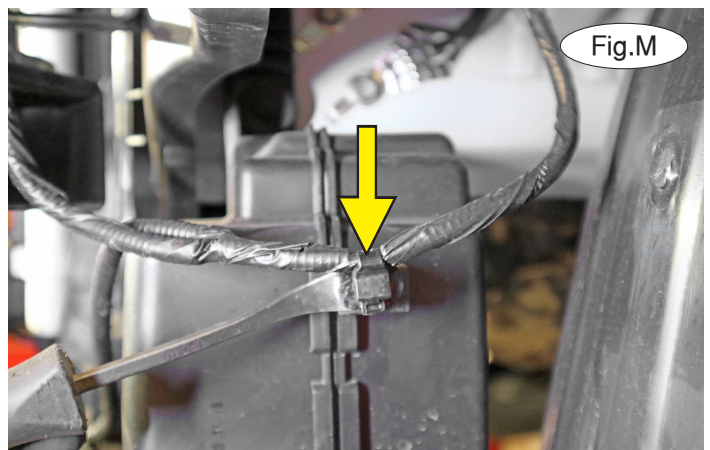
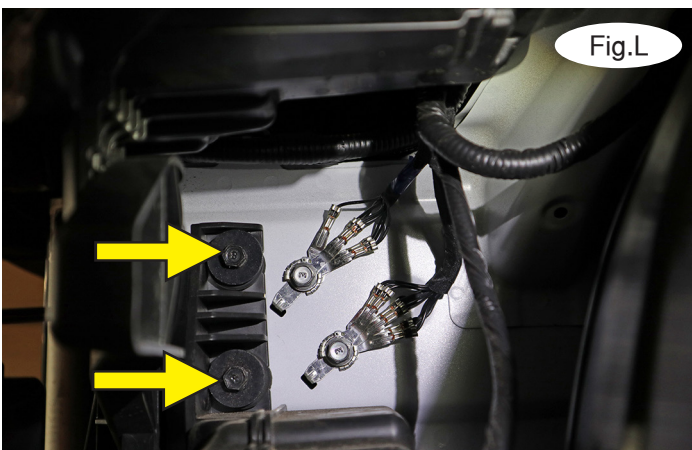



BASEPLATE KIT INSTALLATION INSTRUCTIONS

KIT# 521644-5

06/03/20
KS

ROADMASTER, Inc. 6110 NE 127th Ave. Vancouver, WA 98682 360-896-0407 fax 360-735-9300 www.roadmasterinc.com

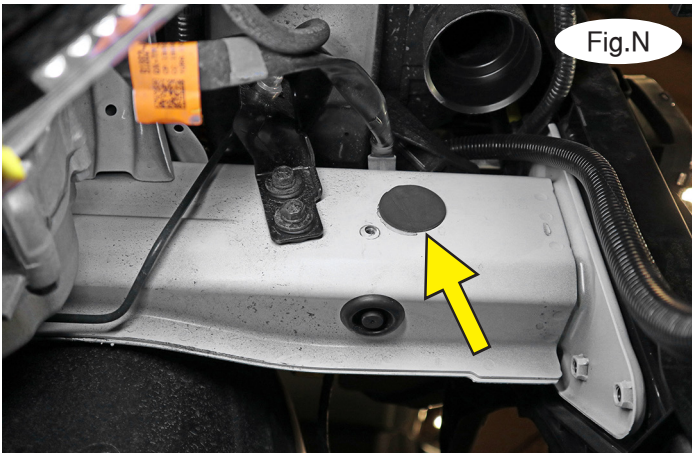

9. On each side, remove a foam cover to expose an access hole on the frame rail (Fig.N). *Note:* For this step and the following one, the passenger side is best accessed from the top of the engine compartment.

10. Working on the passenger side, use the drawing on page 1 to locate the side-specific nutted backing plate. Place a 1/2" lock washer and small flat washer over a 1/2" x 1 3/4" bolt. Place the nutted backing plate end with the spacer into the frame access hole and bolt into it using the 1 3/4" bolt and the hole you exposed in the previous step (Fig.O and Fig.P).

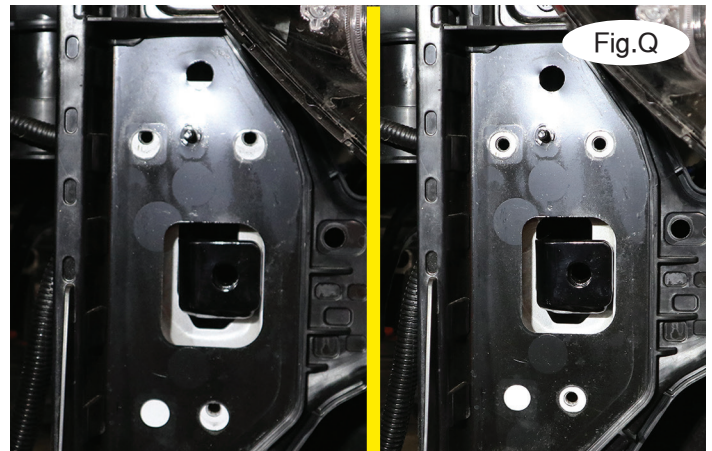

11. Repeat step 10 for the driver's side.

12. Use a jackstand to ensure that the radiator support is centered over the holes (Fig.Q, left – before) and (Fig.Q, right – after).

13. With the help of another person, place the main brace over the bumper core mounts and loosely replace the 12mm bolts from step 6 (Fig.R).

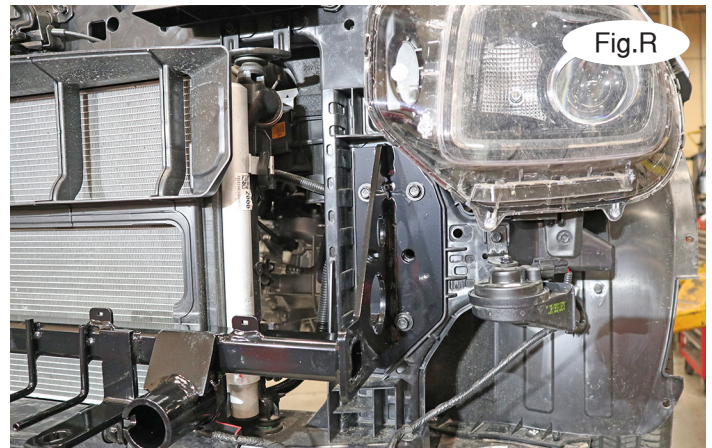



BASEPLATE KIT INSTALLATION INSTRUCTIONS

KIT# 521644-5

06/03/20
KS

ROADMASTER, Inc. 6110 NE 127th Ave. Vancouver, WA 98682 360-896-0407 fax 360-735-9300 www.roadmasterinc.com

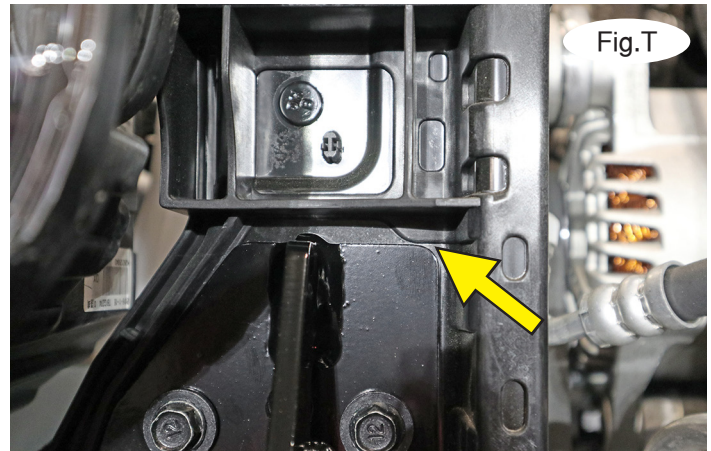
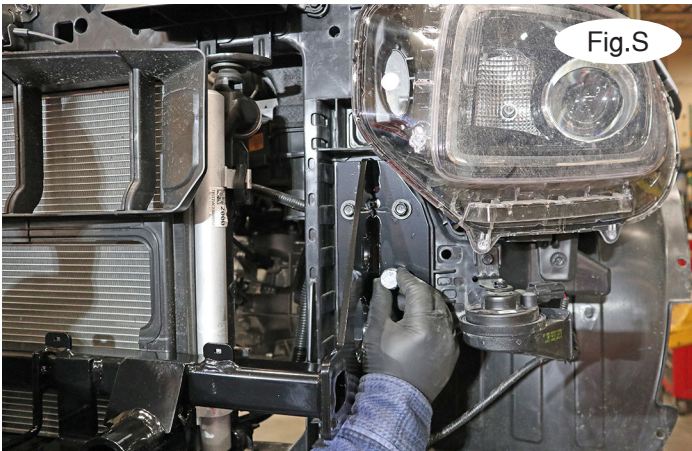

14. Place a 1/2" lock washer over a 1/2" x 1 3/4" bolt and pass it through the baseplate and into the nuted backing plate installed in step 10 (Fig.S).

15. On each side, gently apply upward pressure on the baseplate until it touches at the seam indicated in Figure T. Tighten the 12mm bolts and then all four of the 1/2" bolts (Fig.T). **Note: use Loctite® Red on the bolts.**

16. Reinstall the air box by reversing step 8.

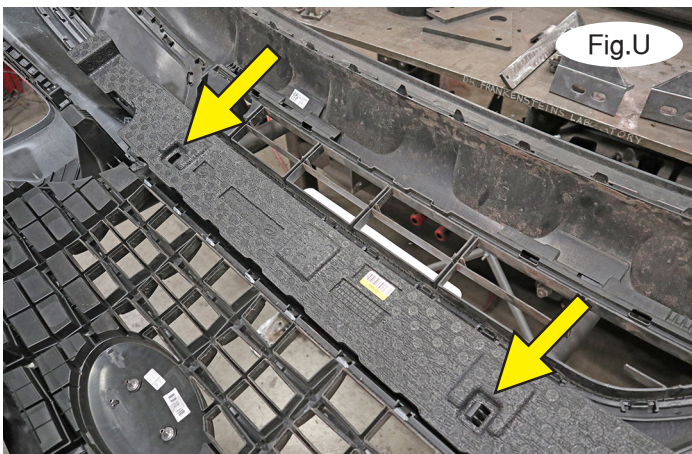

17. On the back of the fascia, release two clips attaching the shock absorption pad to the fascia (Fig.W). It will not be replaced. **Note:** Retain the shock absorption pad in case the baseplate is ever removed from the vehicle.

18. Trim out the template on the last page and, on the passenger side, align the edges with the corner, mark the fascia and trim it (Fig.V). Then, trim the driver's side as shown in Figure W.

19. Reinstall the fascia, reversing steps 1 through 4.

20. On each side, insert the removable front arm into the front receiver 90 degrees from its final towing position, depressing the spring-loaded pin against the receiver. Twist back 90 degrees until the spring-loaded pin snaps into place in the notch on the receiver, locking the arm into place in its final towing position. **Please note: it is the owner's responsibility to ensure the locking of the pins before towing. Otherwise, failure of the towing system will result.**



21. Install the tow bar to the mounting bracket according to the manufacturer's instructions.



BASEPLATE KIT INSTALLATION INSTRUCTIONS

KIT# 521644-5

06/03/20
KS

ROADMASTER, Inc. 6110 NE 127th Ave. Vancouver, WA 98682 360-896-0407 fax 360-735-9300 www.roadmasterinc.com

IMPORTANT!

Safety cables are required by law. When towing, connect safety cables to the safety cable tab shown in Figure X. Make certain there is adequate slack in the cables to allow a full turning radius; otherwise, damage will result. If necessary, longer cables or cable extensions are available.

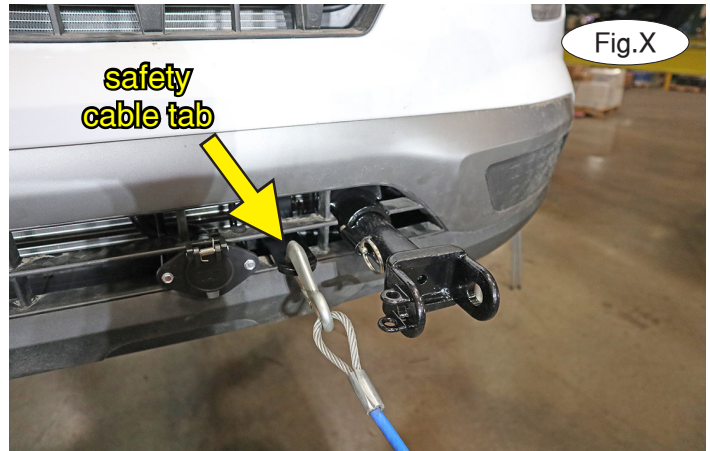

Fig.X

Three options for attaching the wiring plug to the main receiver brace

For six-wire plugs: use the two supplied 3/4" self-tapping screws to attach the electrical plug directly to the rods on the front of the main receiver brace.

For four-wire round plugs: attach to the plug mounting plate and then use the two supplied 3/4" self-tapping screws to attach the mounting plate to the rods on the front of the main receiver brace.

For four-wire flat plugs: place the plug through the mounting plug plate, and then secure it using the supplied zip tie on the front of the plug (Fig.Y). Use the two supplied 3/4" self-tapping screws to attach the mounting plate to the rods on the front of the main receiver brace.

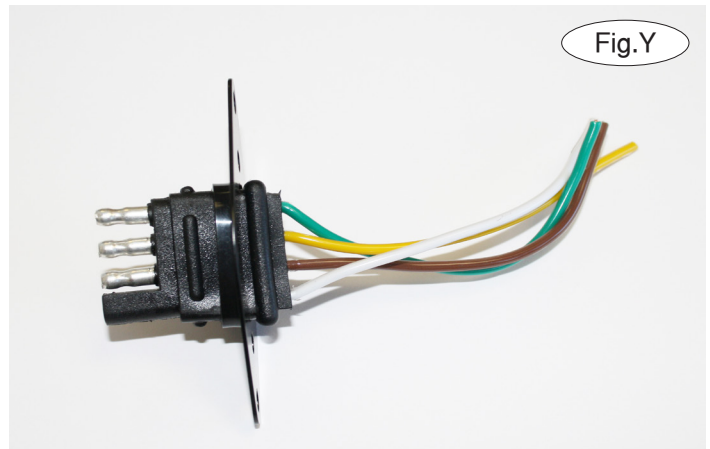

Fig.Y

BOLT TORQUE REQUIREMENTS

Note: The torque values represented below are intended as general guidelines. Torque requirements for specific applications may vary. Roadmaster does not warrant this information to be accurate for all applications and disclaims all liability for any claims or damages which may result from its use.

STANDARD BOLTS

Thread Size	Grade	Torque
5/16	5	13 ft./lb.
3/8	5	23 ft./lb.
7/16	5	37 ft./lb.
1/2	5	56 ft./lb.
5/8	5	150 ft./lb.

METRIC BOLTS

Thread Size	Grade	Plated / Unplated
8mm-1.0	8.8	20 ft./lb. 18 ft./lb.
8mm-1.25	8.8	19 ft./lb. 18 ft./lb.
10mm-1.25	8.8	38 ft./lb. 36 ft./lb.
10mm-1.5	8.8	37 ft./lb. 35 ft./lb.

METRIC BOLTS

Thread Size	Grade	Plated / Unplated
12mm-1.25	8.8	70 ft./lb. 65 ft./lb.
12mm-1.5	8.8	66 ft./lb. 61 ft./lb.
12mm-1.75	8.8	65 ft./lb. 60 ft./lb.
14mm-2.0	8.8	104 ft./lb. 97 ft./lb.

All illustrations and specifications contained herein are based on the latest information available at the time of publication approval. ROADMASTER, INC. reserves the right to make changes at any time without notice in material, specification and models or to discontinue models.

Template for fascia trimming

