



BASEPLATE KIT INSTALLATION INSTRUCTIONS

KIT# 521886-4

08/10/22
KS

ROADMASTER, Inc. 6110 NE 127th Ave. Vancouver, WA 98682 360-896-0407 fax 360-735-9300 www.roadmasterinc.com

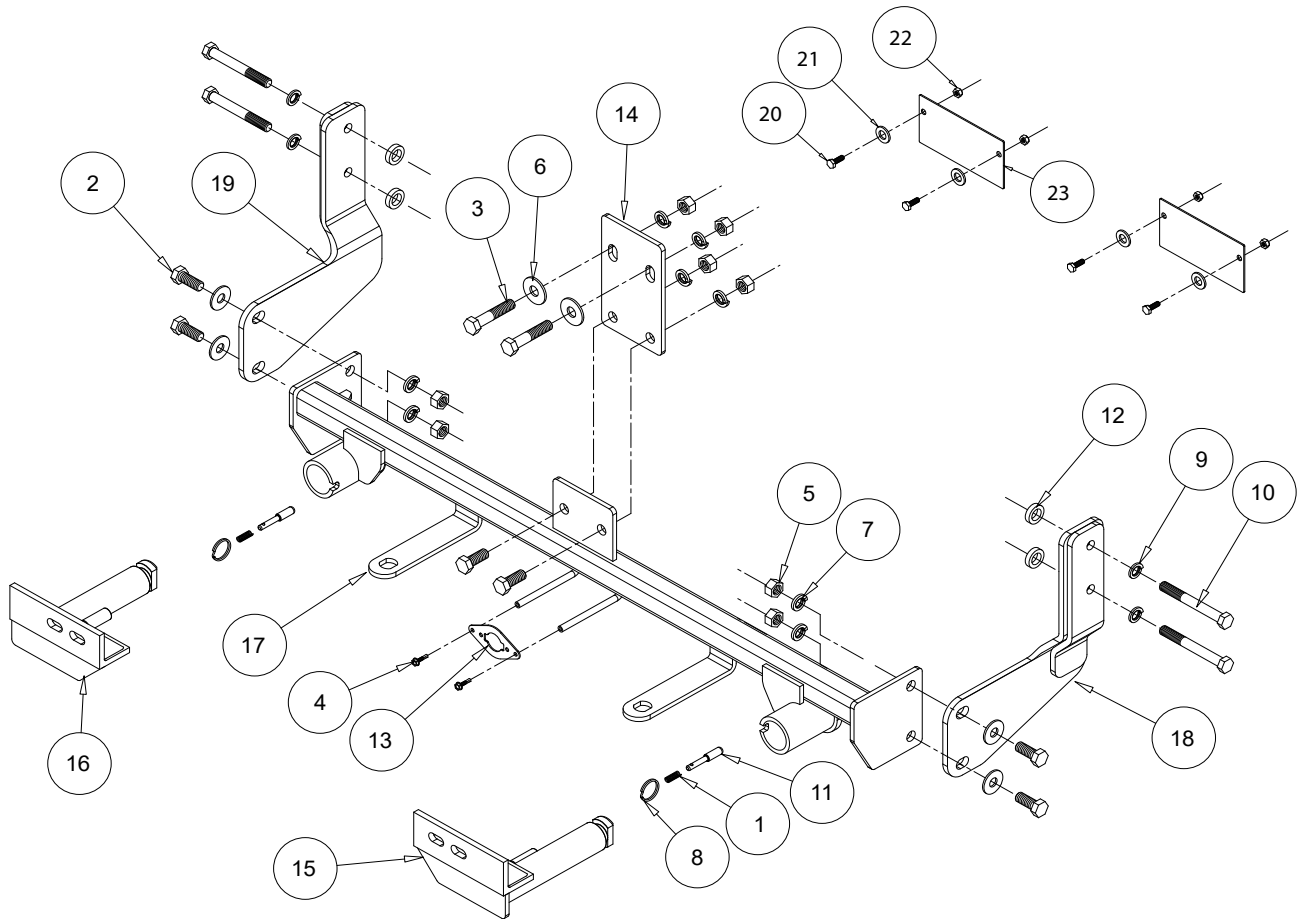

ITEM	QTY	NAME	MATERIAL
1	2	SPRING	200146-00
2	6	1/2" x 1 1/2" BOLT	350095-00
3	2	1/2" x 2 1/2" BOLT	350099-00
4	2	#10 x 3/4" SELF DRILLING SCREW	350247-35
5	8	1/2" NUT	350258-00
6	6	1/2" FLAT WASHER	350308-00
7	8	1/2" LOCK WASHER	350309-00
8	2	RING	350520-00
9	4	M12 LOCK WASHER	355725-00
10	4	M12 x 1.5 x 110mm BOLT	357113-00
11	2	LOCK PIN	A000008
12	4	1" O.D. x 0.188 WALL x 1/4" TUBE SPACER	A001022
13	1	WIRE PLUG PLATE	A003801
14	1	CENTER MOUNTING PLATE	A006551
15	1	DRIVER SIDE ARM	C003687
16	1	PASSENGER SIDE ARM	C003688
17	1	MAIN RECEIVER	C003689
18	1	DRIVER SIDE MOUNT	C003690
19	1	PASSENGER SIDE MOUNT	C003691
20	4	1/4" x 1" BOLT	350005-00
21	4	1/4" FLAT WASHER	350300-00
22	4	1/4" NYLON INSERT LOCK NUT	350251-01
23	2	FENDER PLUG PLATE	A004843



BASEPLATE KIT INSTALLATION INSTRUCTIONS

KIT# 521886-4

08/10/22
KS

ROADMASTER, Inc. 6110 NE 127th Ave. Vancouver, WA 98682 360-896-0407 fax 360-735-9300 www.roadmasterinc.com

This is one of our crossbar-style kits, which allows the visible front portion of the baseplate to be easily removed from the front of the vehicle (Fig.A and Fig.B). The baseplate consists of a main receiver brace, two removable front braces, and a hardware pack.

The main receiver brace mounts to the frame rails, rear braces and the bumper core. The removable front braces install in the main receiver brace.

Before starting the installation, lay out the kit components in order, as they will be used. This will give you a visual idea of how the components work, and will also confirm that everything is present and accounted for.



IMPORTANT: All baseplates **must** be assembled with all the bolts left loose for final adjustment and positioning (before tightening) unless otherwise instructed. All bolts **must** be torqued for proper strength. If more than one bolt is used per fastening point, the diagram may only show one. Use flat washers over all slotted holes and lock washers on all fasteners.

WARNING

Failure to heed these warnings or follow the installation instructions may result in a voided warranty, loss of towed vehicle, personal injury or death.

- Do not weld or modify this baseplate or its components. Welding or modification will void the warranty.
- Do not use this document as a basis to design/fabricate a baseplate, as it may not show all parts or structural components.
- We strongly recommend professional installation.
- If the towed vehicle has been in an accident, it must be properly repaired before attaching the baseplate. Do not install the baseplate if any structural frame damage is found.
- The installer must use all bolts and parts supplied. If running changes were made by the vehicle manufacturer after this kit was designed, some bolts or other fasteners may no longer be the correct size. It is the installer's responsibility to verify this kit is securely fastened to the vehicle.
- Use Loctite® Red on all bolts used to secure this baseplate. Torque all bolts to the specifications found at the end of these instructions. Do not over-torque the bolts or failure may occur.
- The installer must inspect the baseplate to ensure adequate clearance, particularly around hoses, air conditioner lines, radiators, etc. or non-warranty failure may result.
- Roadmaster manufactures many styles of baseplates. If your baseplate has removable arms, they must be removed before driving the vehicle, unless the arms can be pinned or padlocked in place. If not secured, the arms could vibrate out.
- Some motorhome chassis have such a tight turning radius that you can damage your motorhome, towed vehicle, tow bar or baseplate while turning sharply. Before getting on the road, test your turning radius in an empty parking lot. Turning too sharply could result in non-warranty damage to your towing system, motorhome and/or towed vehicle.
- Do not back up with the towed vehicle attached or non-warranty damage will occur to your towing system or vehicles.
- The safety cables must connect the towing vehicle to the towed vehicle frame to frame, with the cables crossed, with enough slack for sharp turns. See cable instructions for proper routing. Failure to do so will result in non-warranty damage and/or the loss of the towed vehicle.
- This kit is designed for use with ROADMASTER tow bars and ROADMASTER adapters only. Using this kit with other brands, without an approved ROADMASTER adapter, may result in non-warranty damage or injury.
- Receiver extensions and out-of-level towing situations of 3 inches or more. This can cause the system to swing much higher and lower, causing excessive strain on the tow bar, baseplate and frame. That can cause the towing system to fail, causing property damage, personal injury or even death. If you must use a receiver extension or drop hitch to tow, it will reduce your receiver's weight capacity by 1/3 to avoid damaging your system. Never use more than one extension and/or drop hitch, as this will void your warranty.
- Every 3,000 miles, the owner must inspect all mounting points for cracks or fatigue, and check the fasteners for proper torque, according to the bolt torque requirements chart on the last page of these instructions.
- The owner must follow the vehicle manufacturer's instructions to prepare the vehicle for towing. Failure to do so may cause severe damage to the vehicle.
- This baseplate is only warranted for the original installation. Installing a used baseplate on another vehicle is not recommended and will void the warranty.



BASEPLATE KIT INSTALLATION INSTRUCTIONS

KIT# 521886-4

08/10/22
KS

ROADMASTER, Inc. 6110 NE 127th Ave. Vancouver, WA 98682 360-896-0407 fax 360-735-9300 www.roadmasterinc.com

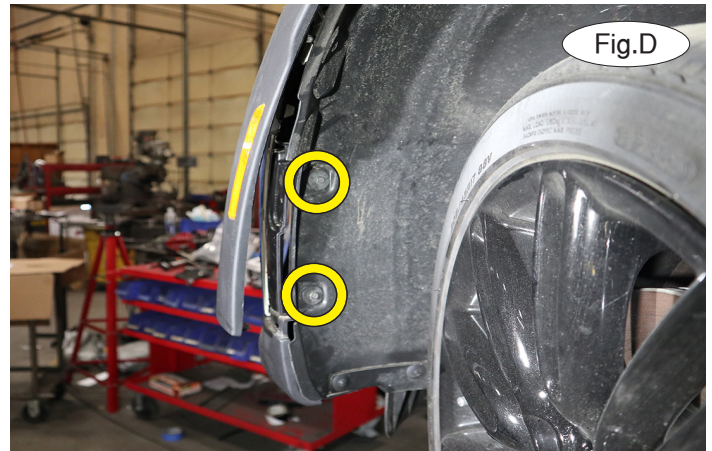
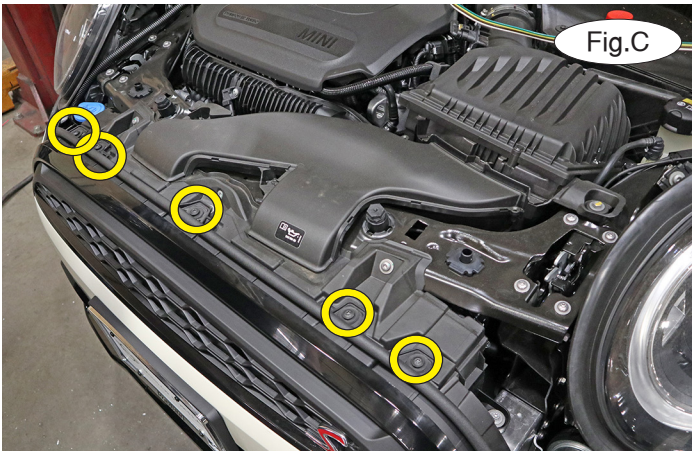

Important: Please use all supplied bolts and parts and read all instructions carefully before beginning this installation. The majority of questions you may have can be answered within the text, and proper installation will ensure safe and secure travel.

1. Begin the installation by removing five T30 Torx (head) screws attaching the upper fascia to the core support (Fig.C).
2. On each side, remove two 8mm screws attaching the fascia to the fender liner (Fig.D).



3. On each side, remove three 8mm (head) screws attaching the fascia to the lower splash shielding and one in the middle (Fig.E).

4. On each side, carefully pull up and out on the fender trim, while releasing from inside the fascia the three clips that are along the forward edge of the trim. Then, continue to pull the trim away from the frame, releasing the two gray clips (Fig.F).

5. On each side, remove one T30 Torx bolt attaching the corner of the fascia to the fender (Fig.G – passenger side). Disconnect the side marker lights, if the vehicle is so equipped.

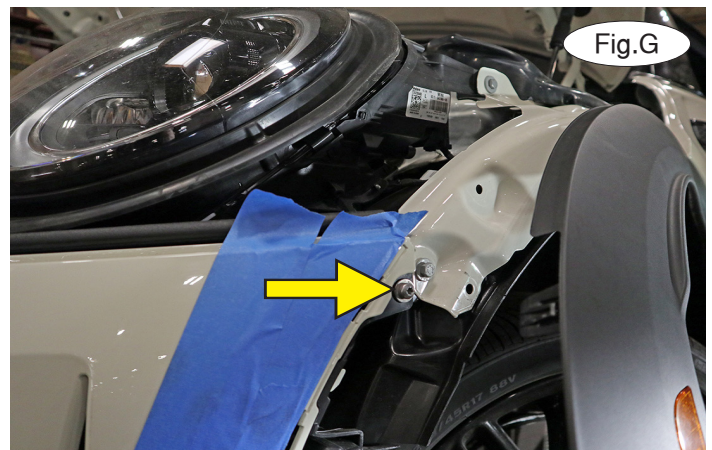



BASEPLATE KIT INSTALLATION INSTRUCTIONS

KIT# 521886-4

08/10/22
KS

ROADMASTER, Inc. 6110 NE 127th Ave. Vancouver, WA 98682 360-896-0407 fax 360-735-9300 www.roadmasterinc.com

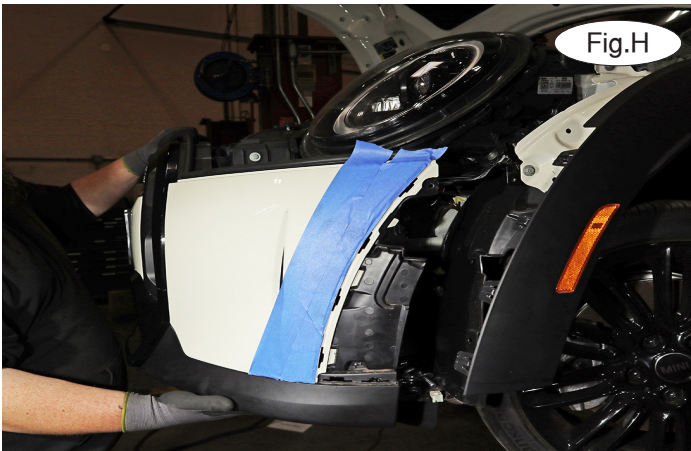

6. On each side, pull out and forward on the corners of the fascia to remove it (Fig.H).

7. On the passenger side only, remove two T30 Torx (head) bolts attaching the top of the washer bottle to the frame (Fig.I). Pull up and out to release the bottle neck and then carefully lift the washer bottle out and maneuver the washer bottle around the framing (Fig.J). Cap off the lines and set it aside for now.



8. On each side, remove two plastic fasteners attaching the back end of the vent tube to the fender liner (Fig.K).

9. On each side, remove one T25 Torx (head) screw attaching the vent tube to the aluminum crossmember (Fig.L). Pull out the vent tube to remove it. The vent tubes will not be replaced.

Note: Retain the vent tubes and attachment fasteners for replacement in case the bracket is ever removed.

Note: On the driver's side, the ambient temperature sensor will also need to be disconnected to remove the vent tube.

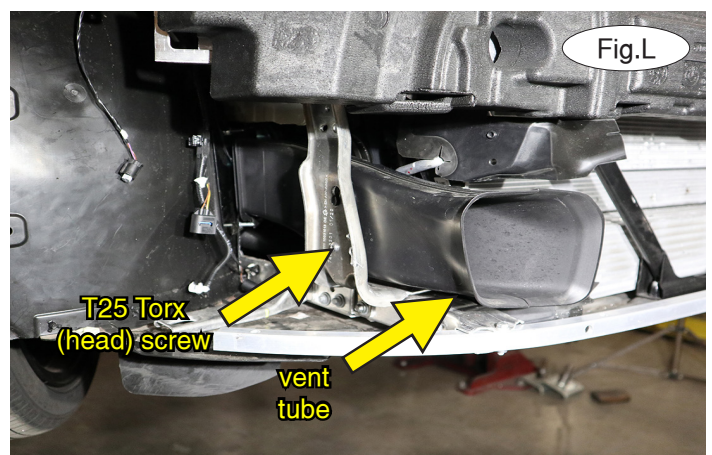



BASEPLATE KIT INSTALLATION INSTRUCTIONS

KIT# 521886-4

08/10/22
KS

ROADMASTER, Inc. 6110 NE 127th Ave. Vancouver, WA 98682 360-896-0407 fax 360-735-9300 www.roadmasterinc.com

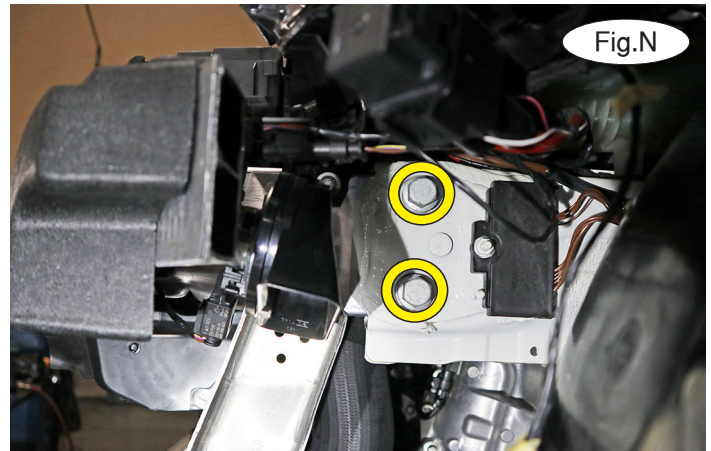
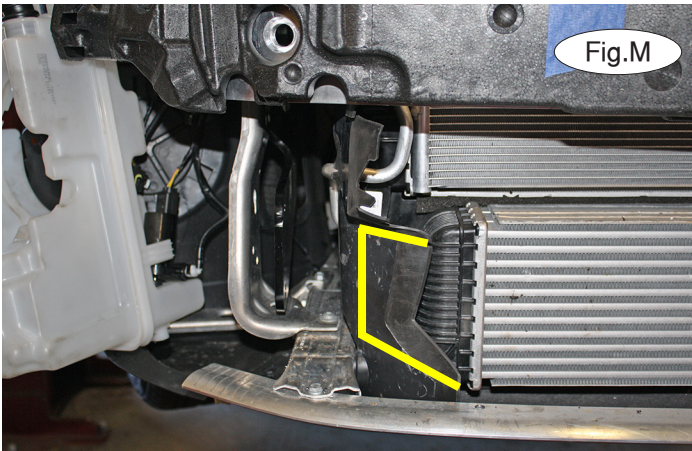

10. On each side, use the yellow reference lines in Figure M to trim the air deflector to allow clearance for the main receiver brace. It should be approximately flush with the intercooler once it is trimmed.

11. On each side, remove two 18mm (head) bolts clamping the bumper core to the frame (Fig.N).

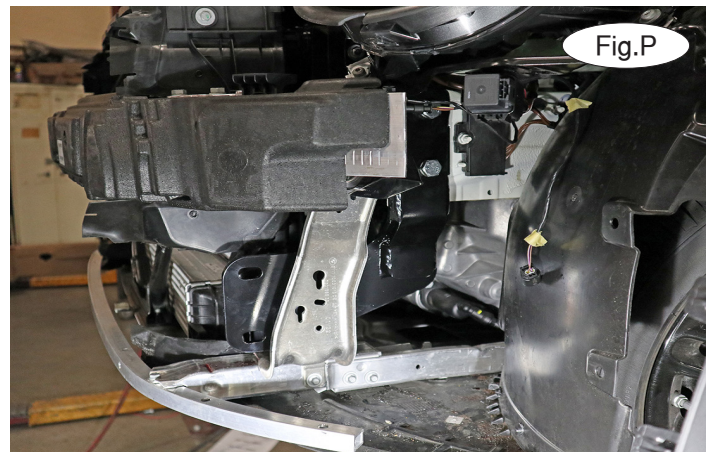
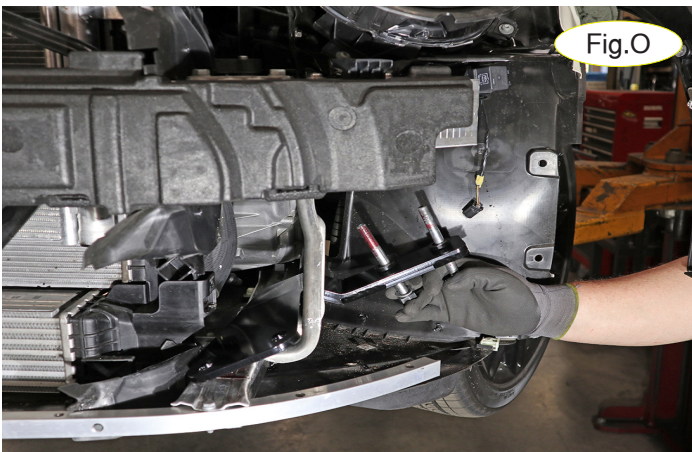

12. On the driver's side only, slide the driver's side rear mounting brace through the aluminum crossmembers. *Note:* use the drawing on page 1 of these instructions for a reference for determining the specific part for each side. Now, using the two supplied 12mm lock washers and 12mm x 1.5 x 110mm bolts, bolt through the upper mounting points, the rear mounting brace, the 1" x ¼" x .188 wall pipe spacers, and into the frame rail (Fig.O and Fig.P). *Note:* ensure proper alignment, as the bolts will receive Loctite® Red and will be torqued at the end of these instructions.

13. Repeat step 12 for the passenger side of the vehicle.

14. Place the main receiver brace between the two rear mounting braces and on each side, using the two supplied ½" x 1½" bolts and ½" flat washers, bolt through the rear mounting brace and the main receiver brace and finish each bolt with a ½" lock washer and nut (Fig.Q).





BASEPLATE KIT INSTALLATION INSTRUCTIONS

KIT# 521886-4

08/10/22
KS

ROADMASTER, Inc. 6110 NE 127th Ave. Vancouver, WA 98682 360-896-0407 fax 360-735-9300 www.roadmasterinc.com

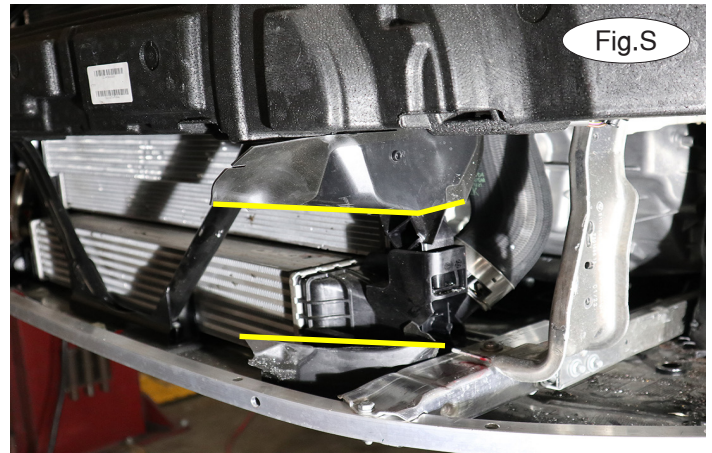

15. Pull back and up on the main receiver brace until it is level and square. Now, tighten the rear bolts first, and then the front bolts to the bolt torque requirements found at the end of these instructions. *Note:* Use Loctite® Red on all nuts and bolts. *Note:* Ensure that the horn is not touching any of the bracket components. If it is, bend it back out of the way.

16. Remove the foam shock absorption pad (Fig.R). It will not be replaced.

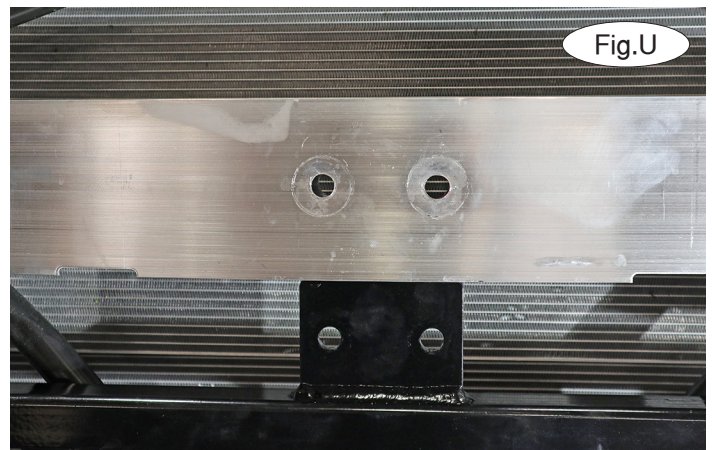
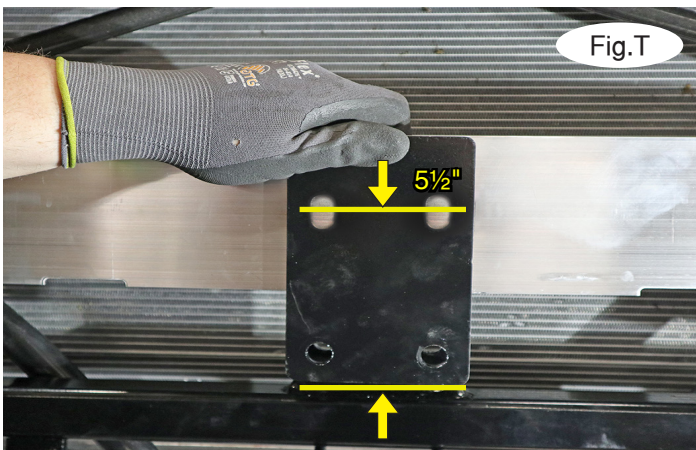

17. On each side, trim the air dam as shown (Fig.S).

18. On the bumper core, draw a horizontal line $5\frac{1}{4}$ " straight up from the top of the crossmember of the main receiver brace to the midpoint of the bumper core. Then, align the support plate with the plate on the crossmember and the horizontal line and then mark the holes for drilling (Fig.T). Using a $\frac{17}{32}$ " drill bit, drill through the bumper core and then bolt the center mounting plate to the back of the bumper core using the two supplied $\frac{1}{2}$ " x $1\frac{1}{4}$ " bolts on the bottom hole and $\frac{1}{2}$ " x $2\frac{1}{2}$ " bolts and $\frac{1}{2}$ " flat washers on the top holes. Finish all four holes with $\frac{1}{2}$ " lock washers and nuts (Fig.U). Then, tighten the bolts to the bolt torque requirements found at the end of these instructions. *Note:* Use Loctite® Red on all nuts and bolts.



19. On each side, place the plug plate over the inside of the fender liner over the hole you exposed in step 9, aligning the holes in the plug plate with the pre-existing holes in the fender liner from step 9. Bolt it in place using the two supplied $\frac{1}{4}$ " x 1" bolts and two $\frac{1}{4}$ " flat washers and finish with two $\frac{1}{4}$ " nylock nuts (Fig.V).



BASEPLATE KIT INSTALLATION INSTRUCTIONS

KIT# 521886-4

08/10/22
KS

ROADMASTER, Inc. 6110 NE 127th Ave. Vancouver, WA 98682 360-896-0407 fax 360-735-9300 www.roadmasterinc.com

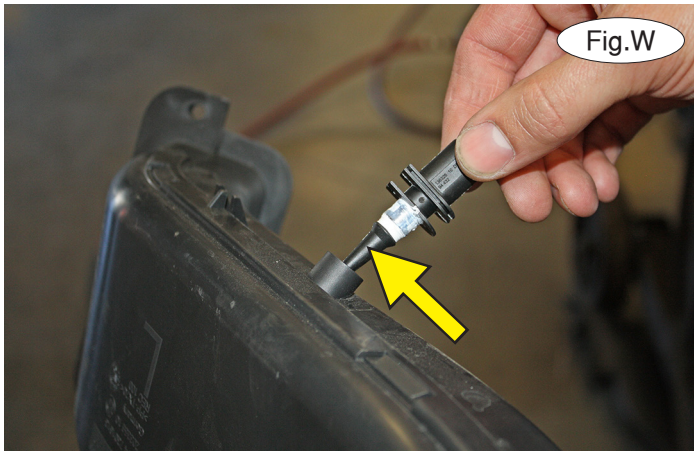

20. Pull the ambient temperature sensor out of the driver's side vent tube (Fig.W) and zip tie it around the fins of the sensor and onto the aluminum crossmember (Fig.X).

21. Replace the washer bottle you relocated in step 7.



22. Reinstall the fascia, reversing steps 1 through 6. *Note: If the gray plastic fasteners did not originally detach with the trim piece (Fig.Y) then you will need to place it in the slotted hole on the trim before reversing step 4. To accomplish this, pop it out of the fender and slide it back into the slot on the inside of the trim.*

23. On each side, trim approximately 1/4" of material off the top, bottom and outside of the fog light housing to allow for clearance of the main receiver brace (Fig.Z). Figure AA shows the final trimming.

24. On each side, insert the removable front arm into the front receiver 90 degrees from its final towing position, depressing the spring-loaded pin against the receiver. Twist back 90 degrees until the spring-loaded pin snaps into place in the notch on the receiver, locking the arm into place in its final towing position. **Please note: It is the owner's responsibility to ensure the locking of the pins before towing. Otherwise, failure of the towing system will result.**



25. Install the tow bar to the baseplate according to the manufacturer's instructions.



BASEPLATE KIT INSTALLATION INSTRUCTIONS

KIT# 521886-4

08/10/22
KS

ROADMASTER, Inc. 6110 NE 127th Ave. Vancouver, WA 98682 360-896-0407 fax 360-735-9300 www.roadmasterinc.com

IMPORTANT!

Safety cables are required by law. When towing, connect safety cables to the safety cable tab shown in the drawing on page 1. Make certain there is adequate slack in the cables to allow a full turning radius; otherwise, damage will result. If necessary, longer cables or cable extensions are available.

Three options for attaching the wiring plug to the main receiver brace

For six-wire plugs: Use the two supplied 3/4" self-tapping screws to attach the electrical plug directly to the rods on the front of the main receiver brace.

For four-wire round plugs: Attach to the plug mounting plate and then use the two supplied 3/4" self-tapping screws to attach the mounting plate to the rods on the front of the main receiver brace.

For four-wire flat plugs: Place the plug through the mounting plug plate, and then secure it using the supplied zip tie on the front of the plug (Fig.BB). Use the two supplied 3/4" self-tapping screws to attach the mounting plate to the rods on the front of the main receiver brace.

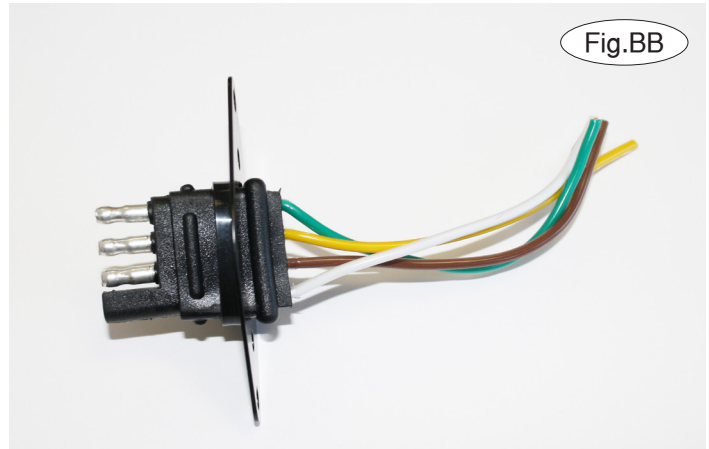

Fig.BB

BOLT TORQUE REQUIREMENTS

Note: The torque values represented below are intended as general guidelines. Torque requirements for specific applications may vary. Roadmaster does not warrant this information to be accurate for all applications and disclaims all liability for any claims or damages which may result from its use.

STANDARD BOLTS

Thread Size	Grade	Torque
5/16.....	5.....	13 ft./lb.
3/8.....	5.....	23 ft./lb.
7/16.....	5.....	37 ft./lb.
1/2.....	5.....	56 ft./lb.
5/8.....	5.....	150 ft./lb.

METRIC BOLTS

Thread Size	Grade	Plated / Unplated
8mm-1.0.....	8.8.....	20 ft./lb. 18 ft./lb.
8mm-1.25.....	8.8.....	19 ft./lb. 18 ft./lb.
10mm-1.25.....	8.8.....	38 ft./lb. 36 ft./lb.
10mm-1.5.....	8.8.....	37 ft./lb. 35 ft./lb.

METRIC BOLTS

Thread Size	Grade	Plated / Unplated
12mm-1.25.....	8.8.....	70 ft./lb. 65 ft./lb.
12mm-1.5.....	8.8.....	66 ft./lb. 61 ft./lb.
12mm-1.75.....	8.8.....	65 ft./lb. 60 ft./lb.
14mm-2.0.....	8.8.....	104 ft./lb. 97 ft./lb.

All illustrations and specifications contained herein are based on the latest information available at the time of publication approval. ROADMASTER, INC. reserves the right to make changes at any time without notice in material, specification and models or to discontinue models.