



BASEPLATE KIT INSTALLATION INSTRUCTIONS

KIT #523160-4

03/25/20
KS

ROADMASTER, Inc. 6110 NE 127th Ave. Vancouver, WA 98682 360-896-0407 fax 360-735-9300 www.roadmasterinc.com

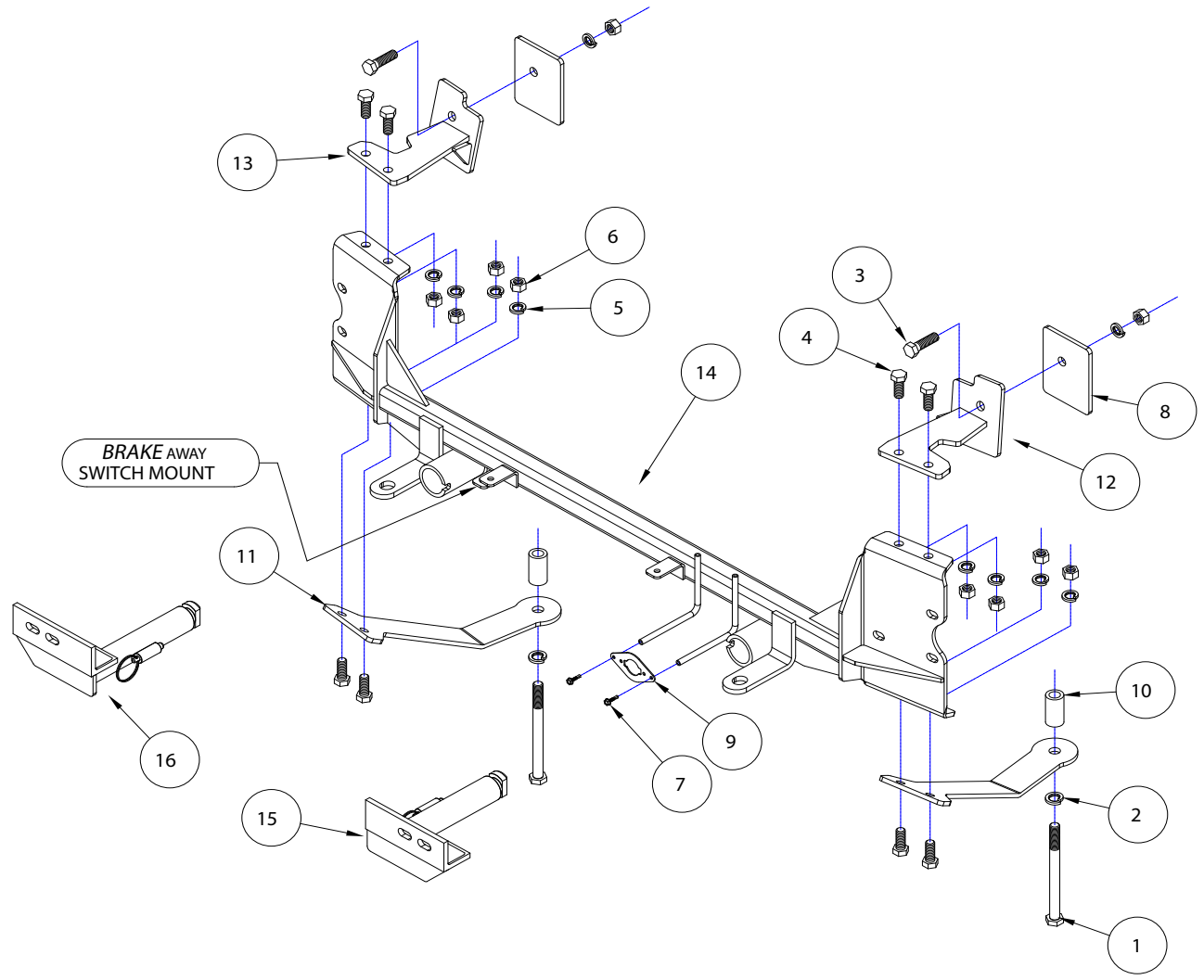

ITEM	QTY	NAME	PART #
1	2	14mm x 2.00 x 160mm BOLT	355910-16
2	2	14mm LOCK WASHER	355740-00
3	2	1/2" x 1 3/4" BOLT	350096-00
4	8	1/2" x 1 1/4" BOLT	350094-00
5	10	1/2" LOCK WASHER	350309-00
6	10	1/2" NUT	350258-00
7	2	#10 x 3/4" SELF DRILLING SCREW	350247-35
8	2	3 1/2" x 4 1/2" BACKING PLATE	A-002964
9	1	WIRE PLUG PLATE	A-003801
10	2	1" O.D. x 1 7/8" TUBE SPACER	A-004511
11	2	LOWER MOUNTING PLATE	B-002454
12	1	DRIVER SIDE UPPER BRACE	C-001879
13	1	PASSENGER SIDE UPPER BRACE	C-001880
14	1	MAIN RECEIVER BRACE	C-003045
15	1	DRIVER SIDE ARM	C-003046
16	1	PASSENGER SIDE ARM	C-003047
17	4	ZIP TIE	300140-10



BASEPLATE KIT INSTALLATION INSTRUCTIONS

KIT #523160-4

03/25/20
KS

ROADMASTER, Inc. 6110 NE 127th Ave. Vancouver, WA 98682 360-896-0407 fax 360-735-9300 www.roadmasterinc.com

This baseplate is one of our crossbar series kits, which allows the visible front portion to be easily removed (Fig.A and Fig.B). The kit consists of the main receiver brace, removable front braces and a hardware pack.

The main receiver brace mounts to the frame. The removable front braces insert into the receivers on each side and are secured with draw pins.

Before starting the installation, lay out the kit components in order, as they will be used. This will give you a visual idea of how the components work, and will also confirm that everything is present and accounted for.



IMPORTANT: All baseplates **must** be assembled with all the bolts left loose for final adjustment and positioning (before tightening) unless otherwise instructed. All bolts **must** be torqued for proper strength. If more than one bolt is used per fastening point, the diagram may only show one. Use flat washers over all slotted holes and lock washers on all fasteners.

WARNING

Failure to heed these warnings or follow the installation instructions may result in a voided warranty, loss of towed vehicle, personal injury or death.

- Do not weld or modify this baseplate or its components. Welding or modification will void the warranty.
- Do not use this document as a basis to design/fabricate a baseplate, as it may not show all parts or structural components.
- We strongly recommend professional installation.
- If the towed vehicle has been in an accident, it must be properly repaired before attaching the baseplate. Do not install the baseplate if any structural frame damage is found.
- The installer must use all bolts and parts supplied. If running changes were made by the vehicle manufacturer after this kit was designed, some bolts or other fasteners may no longer be the correct size. It is the installer's responsibility to verify this kit is securely fastened to the vehicle.
- Use Loctite® Red on all bolts used to secure this baseplate. Torque all bolts to the specifications found at the end of these instructions. Do not over-torque the bolts or failure may occur.
- The installer must inspect the baseplate to ensure adequate clearance, particularly around hoses, air conditioner lines, radiators, etc. or non-warranty failure may result.
- Roadmaster manufactures many styles of baseplates. If your baseplate has removable arms, they must be removed before driving the vehicle, unless the arms can be pinned or padlocked in place. If not secured, the arms could vibrate out.
- Some motorhome chassis have such a tight turning radius that you can damage your motorhome, towed vehicle, tow bar or baseplate while turning sharply. Before getting on the road, test your turning radius in an empty parking lot. Turning too sharply could result in non-warranty damage to your towing system, motorhome and/or towed vehicle.
- Do not back up with the towed vehicle attached or non-warranty damage will occur to your towing system or vehicles.
- The safety cables must connect the towing vehicle to the towed vehicle frame to frame, with the cables crossed, with enough slack for sharp turns. See cable instructions for proper routing. Failure to do so will result in non-warranty damage and/or the loss of the towed vehicle.
- This kit is designed for use with ROADMASTER tow bars and ROADMASTER adapters only. Using this kit with other brands, without an approved ROADMASTER adapter, may result in non-warranty damage or injury.
- Receiver extensions and out-of-level towing situations of 3 inches or more. This can cause the system to swing much higher and lower, causing excessive strain on the tow bar, baseplate and frame. That can cause the towing system to fail, causing property damage, personal injury or even death. If you must use a receiver extension or drop hitch to tow, it will reduce your receiver's weight capacity by 1/3 to avoid damaging your system. Never use more than one extension and/or drop hitch, as this will void your warranty.
- Every 3,000 miles, the owner must inspect all mounting points for cracks or fatigue, and check the fasteners for proper torque, according to the bolt torque requirements chart on the last page of these instructions.
- The owner must follow the vehicle manufacturer's instructions to prepare the vehicle for towing. Failure to do so may cause severe damage to the vehicle.
- This baseplate is only warranted for the original installation. Installing a used baseplate on another vehicle is not recommended and will void the warranty.



BASEPLATE KIT INSTALLATION INSTRUCTIONS

KIT #523160-4

03/25/20
KS

ROADMASTER, Inc. 6110 NE 127th Ave. Vancouver, WA 98682 360-896-0407 fax 360-735-9300 www.roadmasterinc.com

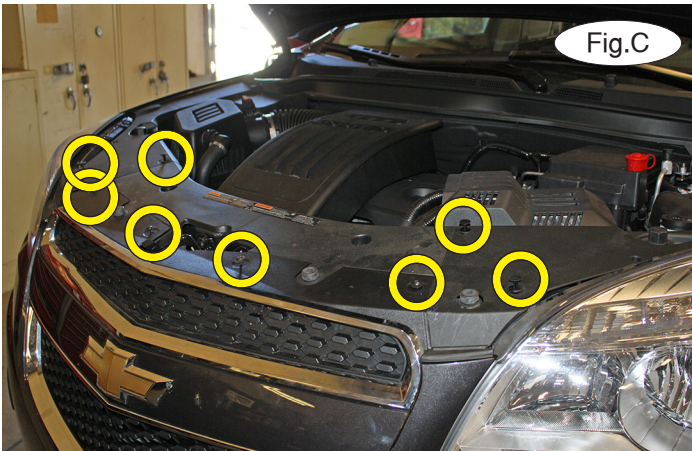

1. **Important:** please use all supplied bolts and parts and read all instructions carefully before beginning this installation. The majority of questions you may have can be answered within the text, and proper installation will ensure safe and secure travel. Now, begin the installation. Remove four plastic fasteners and either four 7mm (head) screws or four T20 torx bolts attaching the top of the fascia to the core support (Fig.C).

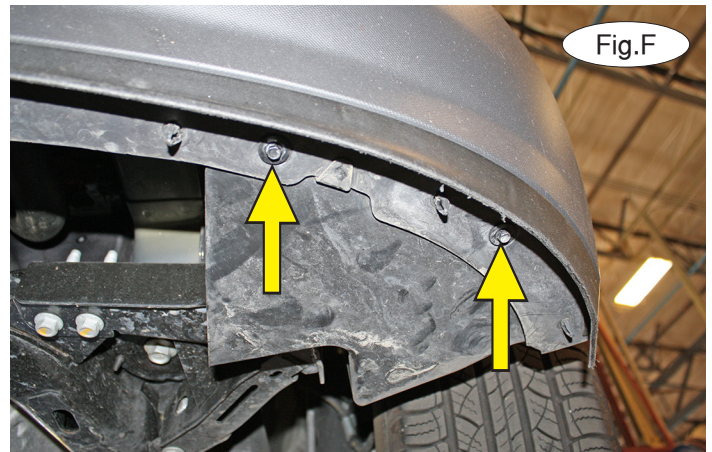

2. On each side, remove one 7mm (head) screw attaching the corner of the fascia to the fender (Fig.D).
3. On each side, remove one T20 Torx screw and three plastic fasteners attaching the fender liner to the fascia (Fig.E).

Note: due to manufacturing variances, there may be two screws and two plastic fasteners.

4. On each side, remove two T20 Torx screws attaching the bottom of the fender liners to the fascia (Fig. F – driver's side). *Note:* due to manufacturing variances, there may be two 7mm screws instead.

5. Disconnect the fog lights, if the vehicle is so equipped. Pull forward on the corners of the fascia to remove the locking strip (Fig.G).

Now, go to the supplemental instructions at this time if the vehicle is equipped with a power steering cooler. If not, continue with step 6.

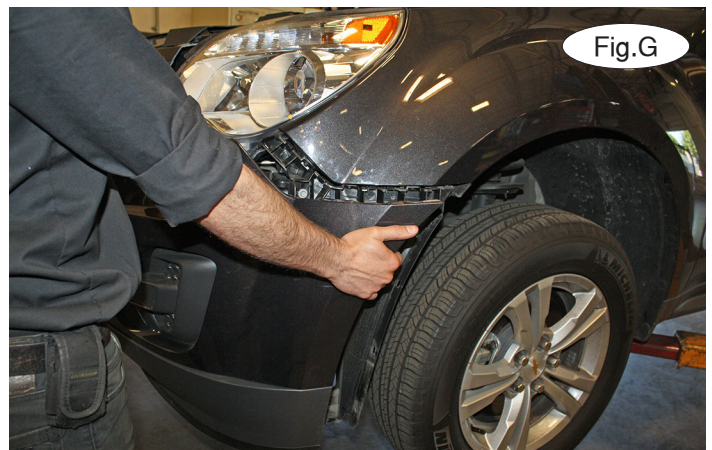



BASEPLATE KIT INSTALLATION INSTRUCTIONS

KIT #523160-4

03/25/20
KS

ROADMASTER, Inc. 6110 NE 127th Ave. Vancouver, WA 98682 360-896-0407 fax 360-735-9300 www.roadmasterinc.com

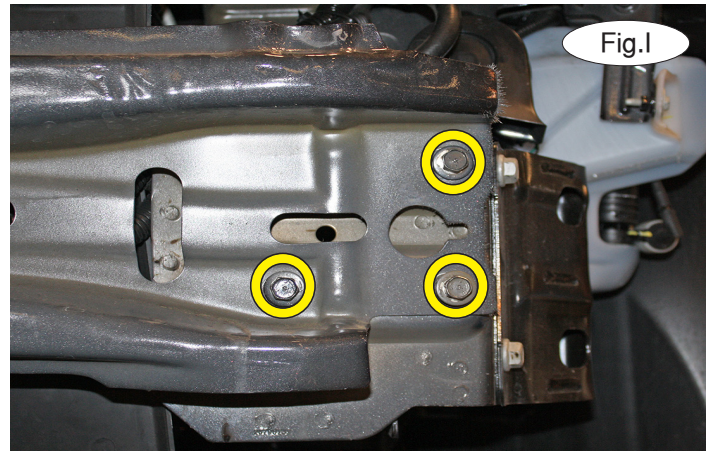

6. Unsnap five plastic clips to remove the wiring harness from the back of the bumper core (Fig.H).

7. On each side, remove three 13mm (head) bolts attaching the bumper core to the frame rails (Fig.I). The bumper core will not be replaced. Retain the bumper core in case the bracket is ever removed. *Note:* due to manufacturing variances, there may be four 13mm (head) bolts instead.

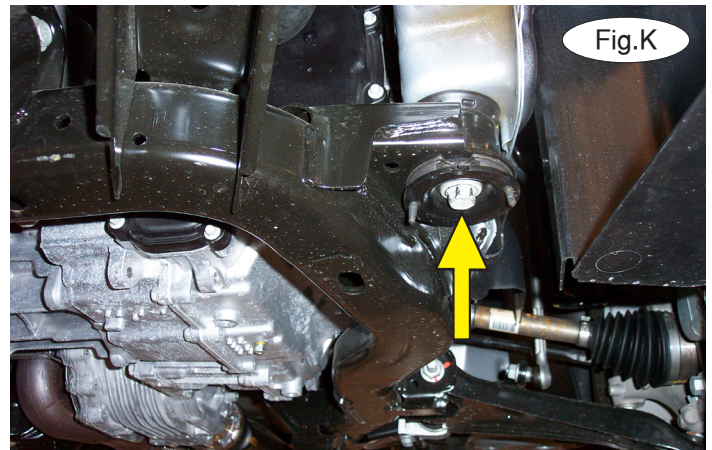
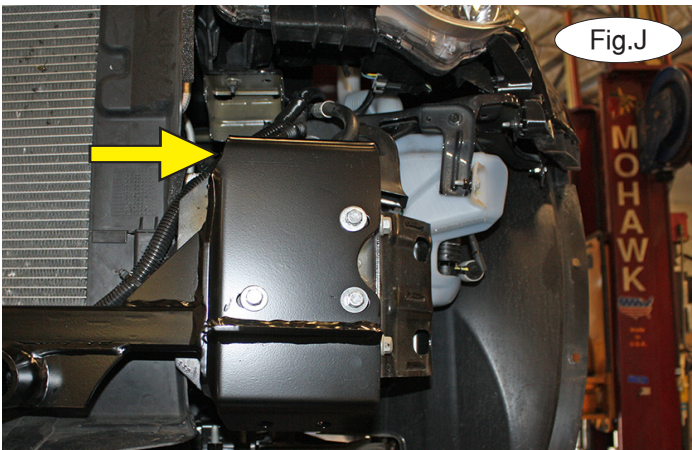

8. Before you install the main receiver brace, unsnap the fastener securing the loom to the frame on each side (Fig.J – yellow arrow).

Now, place thread lock on the bolts you removed in the previous step and use them to attach the main receiver brace to the ends of the frame rails (Fig.J).

Tighten the bolts to the bolt torque requirements found at the end of these instructions.

9. Working on the driver's side, remove the 18mm subframe bolt (Fig.K). **Note: do not remove both subframe bolts without supporting the frame.** *Note:* due to manufacturing variances, you may notice some additional framing on your vehicle.

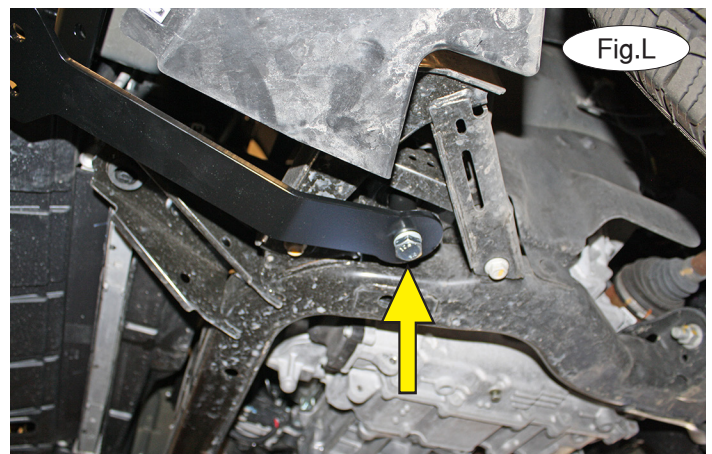

10. Place thread lock on one of the supplied 14mm x 2.0 x 160mm bolts, and bolt through the lower rear brace and a 1" x 1 7/8" pipe spacer and into the subframe (Fig.L).



BASEPLATE KIT INSTALLATION INSTRUCTIONS

KIT #523160-4

03/25/20
KS

ROADMASTER, Inc. 6110 NE 127th Ave. Vancouver, WA 98682 360-896-0407 fax 360-735-9300 www.roadmasterinc.com

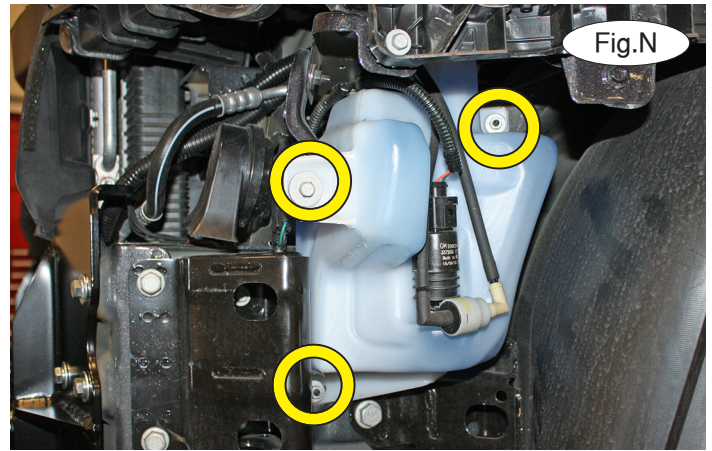
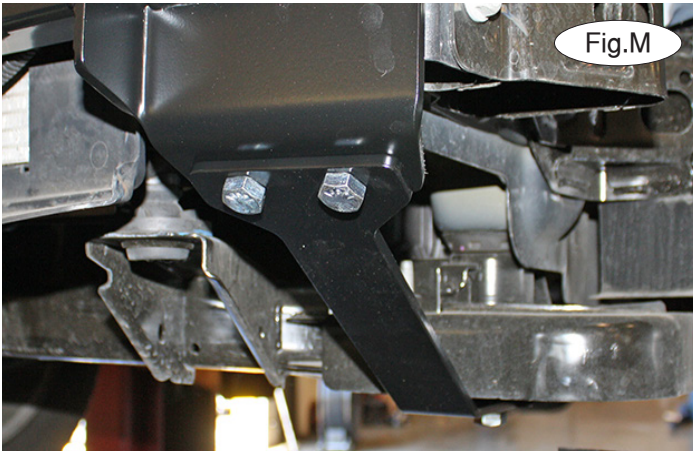

11. Using two of the supplied $\frac{1}{2}$ " x $1\frac{1}{4}$ " bolts, lock washers and nuts, bolt the lower rear brace to the main receiver brace (Fig.M). Tighten the bolts to the bolt torque requirements found at the end of this document.
12. Repeat steps 9 through 11 for the passenger side of the vehicle.
13. Working on the driver's side, remove the 10mm bolt and two 10mm nuts attaching the washer bottle to the frame rail (Fig.N). Unmount the washer bottle and let it hang down for now.

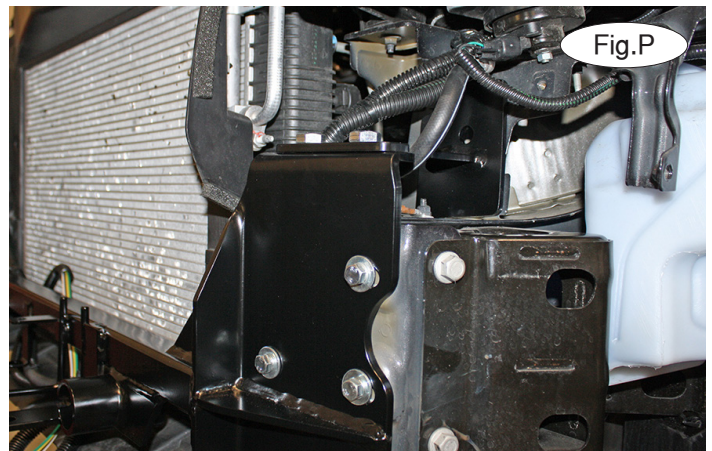
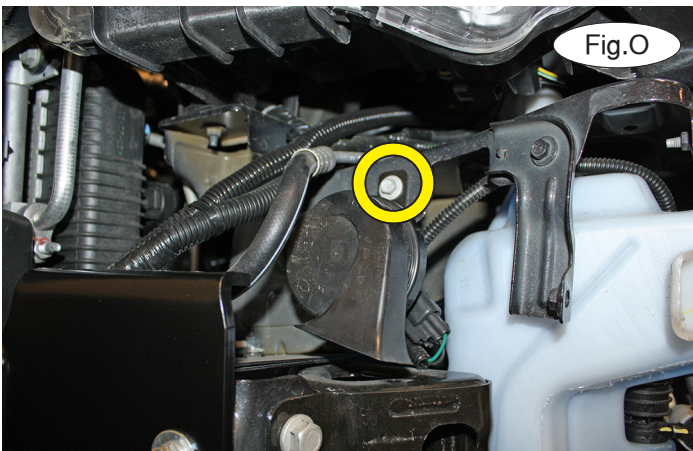

14. Remove one 10mm (head) bolt attaching the horn to the framing on the driver's side (Fig.O).
15. Position the driver's side upper rear brace over the top of the main receiver brace, aligning the holes. Then, using two of the supplied $\frac{1}{2}$ " x $1\frac{1}{4}$ " bolts, lock washers and nuts, bolt the upper rear brace to the main receiver brace (Fig.P).
16. Place one of the $3\frac{1}{2}$ " x $4\frac{1}{2}$ " backing plates through the opening in the side of the frame behind the upper rear brace, aligning its hole with the hole in the upper rear brace (Fig.Q).

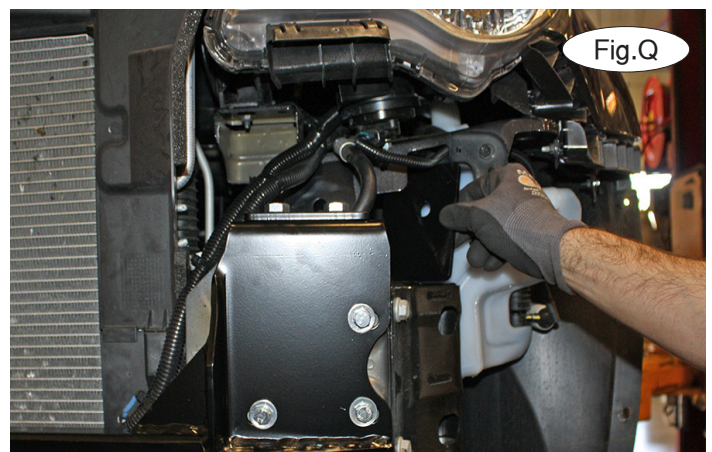



BASEPLATE KIT INSTALLATION INSTRUCTIONS

KIT #523160-4

03/25/20
KS

ROADMASTER, Inc. 6110 NE 127th Ave. Vancouver, WA 98682 360-896-0407 fax 360-735-9300 www.roadmasterinc.com

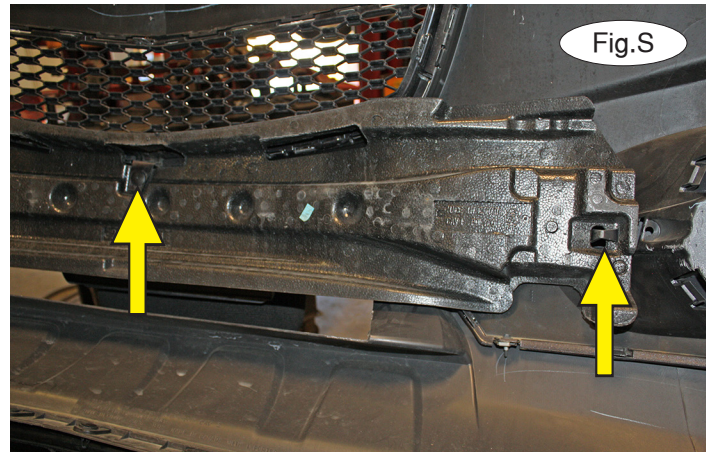

17. Bolt the backing plate to the upper rear brace using one of the supplied $\frac{1}{2}$ " x $1\frac{1}{2}$ " bolts, lock washers and nuts (Fig.R).

18. Torque the bolts to the bolt torque requirements found at the end of this document.

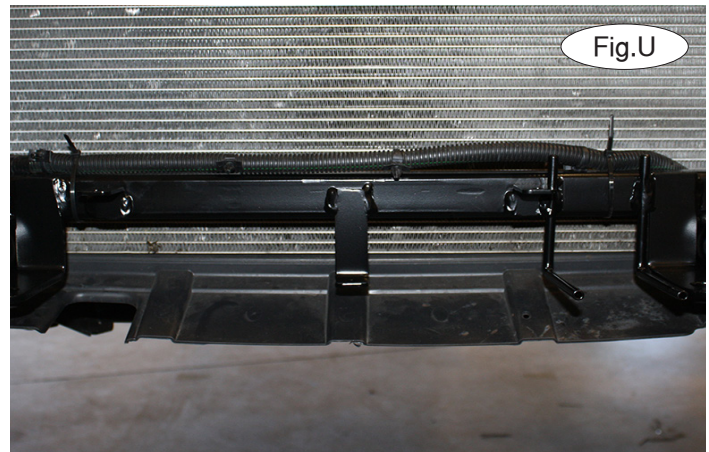

19. **Reverse** steps 13 and 14, and then **repeat** 15 through 18 for the passenger side of the vehicle. Now, return to step 3 in the supplemental instructions at this time, if the vehicle is equipped with a power steering cooler. If not, continue with step 20.

20. Remove the foam shock absorption pad from the back of the fascia by removing two plastic clips and one fastener. It will not be replaced. Retain the foam shock absorption pad and its attachment hardware for replacement in case the bracket is ever removed. *Note:* Figure S only shows one clip and the fastener.

21. Trim the fascia using Figure T as a reference.

22. Using two of the supplied zip ties, attach the wiring harness to the main receiver brace (Fig.U).

23. Reassemble the fascia by reversing steps 1 through 5. Now, return to step 7 in the supplement if your vehicle is equipped with a power steering cooler. If not, continue with step 24.

24. On each side, insert the removable front arm into the front receiver 90 degrees from its final towing position, depressing the spring-loaded pin against the receiver. Twist back 90 degrees until the spring-loaded pin snaps into place in the notch on the receiver, locking the arm into place in its final towing position. **Please note: it is the owner's responsibility to ensure the locking of the pins before towing. Otherwise, failure of the towing system will result.**

IMPORTANT!

Safety cables are required by law. When towing, connect safety cables to the safety cable tabs illustrated on page 1. Make certain there is adequate slack in the cables to allow a full turning radius; otherwise, damage will result. If necessary, longer cables or cable extensions are available.



BASEPLATE KIT INSTALLATION INSTRUCTIONS

KIT #523160-4

03/25/20
KS

ROADMASTER, Inc. 6110 NE 127th Ave. Vancouver, WA 98682 360-896-0407 fax 360-735-9300 www.roadmasterinc.com

Three options for attaching the wiring plug to the main receiver brace

For six-wire plugs: use the two supplied 3/4" self-tapping screws to attach the electrical plug directly to the rods on the front of the main receiver brace.

For four-wire round plugs: attach to the plug mounting plate and then use the two supplied 3/4" self-tapping screws to attach the mounting plate to the rods on the front of the main receiver brace.

For four-wire flat plugs: place the plug through the mounting plug plate, and then secure it using the supplied zip tie on the front of the plug (Fig.V). Use the two supplied 3/4" self-tapping screws to attach the mounting plate to the rods on the front of the main receiver brace.

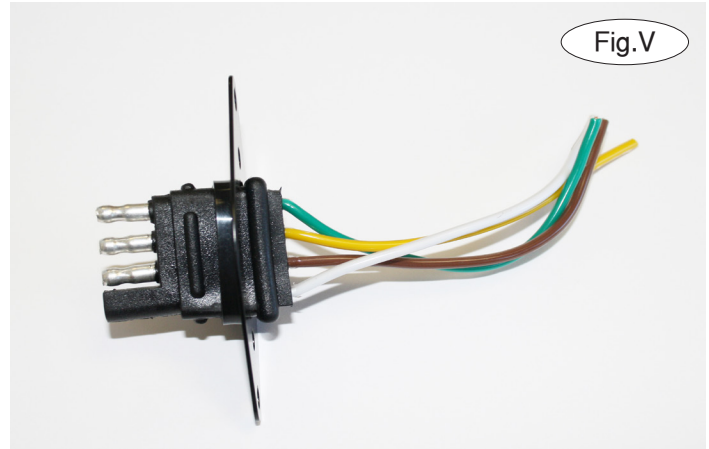

Fig.V

BOLT TORQUE REQUIREMENTS

Note: The torque values represented below are intended as general guidelines. Torque requirements for specific applications may vary. Roadmaster does not warrant this information to be accurate for all applications and disclaims all liability for any claims or damages which may result from its use.

STANDARD BOLTS

Thread Size	Grade	Torque
5/16-18	5	13 ft./lb.
3/8-16	5	23 ft./lb.
7/16-14	5	37 ft./lb.
1/2-13	5	57 ft./lb.
5/8-11	5	112 ft./lb.

METRIC BOLTS

Thread Size	Grade	Torque
6mm-1.0	8.8	6 ft./lb.
8mm-1.0	8.8	18 ft./lb.
8mm-1.25	8.8	16 ft./lb.
10mm-1.25	8.8	36 ft./lb.
10mm-1.5	8.8	31 ft./lb.

METRIC BOLTS

Thread Size	Grade	Torque
12mm-1.25	8.8	64 ft./lb.
12mm-1.5	8.8	60 ft./lb.
12mm-1.75	8.8	55 ft./lb.
14mm-2.0	8.8	88 ft./lb.



BASEPLATE KIT INSTALLATION INSTRUCTIONS

KIT #523160-4

03/25/20
KS

ROADMASTER, Inc. 6110 NE 127th Ave. Vancouver, WA 98682 360-896-0407 fax 360-735-9300 www.roadmasterinc.com

Supplemental Instructions to Remove the Power Steering Cooler

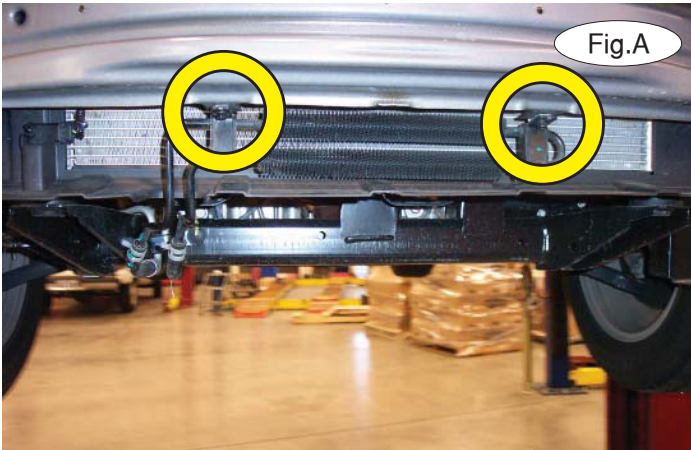

1. Remove the power steering cooler from the bumper core by removing two 10mm (head) bolts (Fig.A).
2. Now, return to the regular instructions to complete steps 6 through 19 before moving on to the next step.
3. Remove the slip nuts from the bumper core (Fig.B).



4. Place the slip nuts on the power steering cooler mounting points on the main receiver brace (Fig.C).
5. Bolt the power steering cooler to the mounts on the main receiver brace using the factory bolts you removed in step 1 in these supplemental instructions (Fig.D – passenger side bolt). *Note:* due to manufacturing variances, the vehicle may look slightly different than what you see in Figure D.
6. Now, proceed to steps 20 through 23 in the regular instructions before moving on to the next step.
7. If the power steering cooler lines contact the lower half of the fascia and the backside of the grille opening, use the red lines in Figure E as a guide to trim a small amount of the fascia and the grille to allow for clearance.

