



BASEPLATE KIT INSTALLATION INSTRUCTIONS

KIT# 523173-1

12/01/15
KS

ROADMASTER, Inc. 6110 NE 127th Ave. Vancouver, WA 98682 360-896-0407 fax 360-735-9300 www.roadmasterinc.com

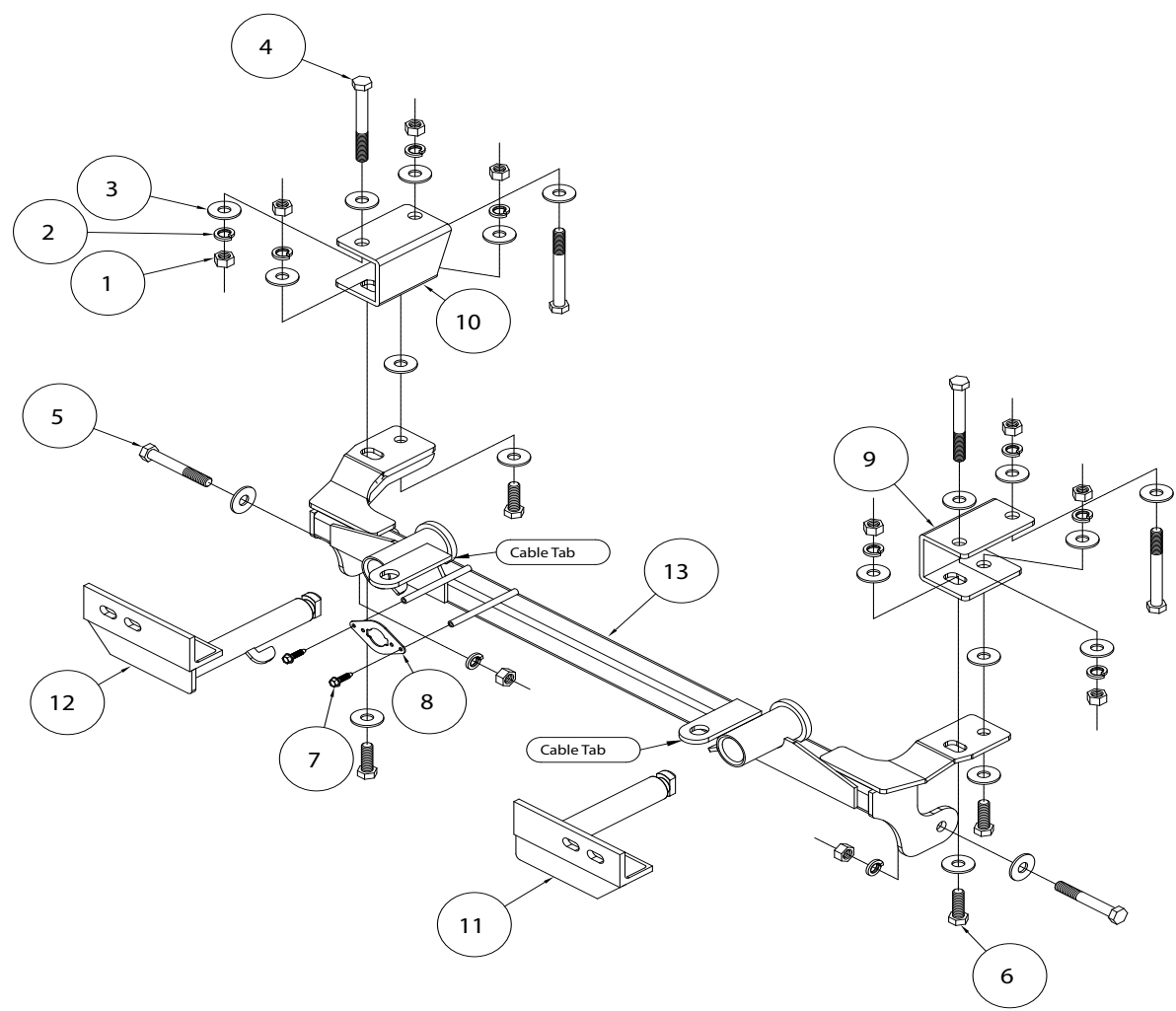

ITEM	QTY	NAME	MATERIAL
1.....	10.....	1/2" HEX NUT.....	350258-00
2.....	10.....	1/2" LOCK WASHER.....	350309-00
3.....	20.....	1/2" FLAT WASHER.....	350308-20
4.....	4.....	1/2" x 4 1/2" BOLT.....	350106-00
5.....	2.....	1/2" x 3 1/2" BOLT.....	350103-00
6.....	4.....	1/2" x 1 1/2" BOLT.....	350095-00
7.....	2.....	#10 x 3/4" SELF TAPPING SCREW.....	350247-35
8.....	1.....	WIRE PLUG PLATE.....	A-003801
9.....	1.....	DRIVER SIDE BRACE.....	B-002056
10.....	1.....	PASSENGER SIDE BRACE.....	B-002057
11.....	1.....	DRIVER SIDE ARM.....	C-002422
12.....	1.....	PASSENGER SIDE ARM.....	C-002423
13.....	1.....	MAIN RECEIVER.....	C-002424
14.....	1.....	ZIP TIE.....	300140-8



BASEPLATE KIT INSTALLATION INSTRUCTIONS

KIT# 523173-1

12/01/15
KS

ROADMASTER, Inc. 6110 NE 127th Ave. Vancouver, WA 98682 360-896-0407 fax 360-735-9300 www.roadmasterinc.com

This is one of our EZ2 series brackets, which allows the visible front portion of the bracket to be easily removed from the front of the vehicle (Fig.A and Fig.B). The bracket consists of a main receiver brace, two support braces, two removable front braces, and a hardware pack.

The main receiver brace mounts to the support braces, bumper core and lower bumper. The removable front braces install in the main receiver brace.

Before starting the installation, lay out the kit components in order, as they will be used. This will give you a visual idea of how the components work, and will also confirm that everything is present and accounted for.



IMPORTANT: All baseplates **must** be assembled with all the bolts left loose for final adjustment and positioning (before tightening) unless otherwise instructed. All bolts **must** be torqued for proper strength. If more than one bolt is used per fastening point, the diagram may only show one. Use flat washers over all slotted holes and lock washers on all fasteners.

WARNING

Failure to heed these warnings or follow the installation instructions may result in a voided warranty, loss of towed vehicle, personal injury or death.

- Do not weld or modify this baseplate or its components. Welding or modification will void the warranty.
- Do not use this document as a basis to design/fabricate a baseplate, as it may not show all parts or structural components.
- We strongly recommend professional installation.
- If the towed vehicle has been in an accident, it must be properly repaired before attaching the baseplate. Do not install the baseplate if any structural frame damage is found.
- The installer must use all bolts and parts supplied. If running changes were made by the vehicle manufacturer after this kit was designed, some bolts or other fasteners may no longer be the correct size. It is the installer's responsibility to verify this kit is securely fastened to the vehicle.
- Use Loctite® Red on all bolts used to secure this baseplate. Torque all bolts to the specifications found at the end of these instructions. Do not over-torque the bolts or failure may occur.
- The installer must inspect the baseplate to ensure adequate clearance, particularly around hoses, air conditioner lines, radiators, etc. or non-warranty failure may result.
- Roadmaster manufactures many styles of baseplates. If your baseplate has removable arms, they must be removed before driving the vehicle, unless the arms can be pinned or padlocked in place. If not secured, the arms could vibrate out.
- Some motorhome chassis have such a tight turning radius that you can damage your motorhome, towed vehicle, tow bar or baseplate while turning sharply. Before getting on the road, test your turning radius in an empty parking lot. Turning too sharply could

result in non-warranty damage to your towing system, motorhome and/or towed vehicle.

- Do not back up with the towed vehicle attached or non-warranty damage will occur to your towing system or vehicles.
- The safety cables must connect the towing vehicle to the towed vehicle frame to frame, with the cables crossed, with enough slack for sharp turns. See cable instructions for proper routing. Failure to do so will result in non-warranty damage and/or the loss of the towed vehicle.
- This kit is designed for use with ROADMASTER tow bars and ROADMASTER adapters only. Using this kit with other brands, without an approved ROADMASTER adapter, may result in non-warranty damage or injury.
- Receiver extensions and out-of-level towing situations of 3 inches or more. This can cause the system to swing much higher and lower, causing excessive strain on the tow bar, baseplate and frame. That can cause the towing system to fail, causing property damage, personal injury or even death. If you must use a receiver extension or drop hitch to tow, it will reduce your receiver's weight capacity by 1/3 to avoid damaging your system. Never use more than one extension and/or drop hitch, as this will void your warranty.
- Every 3,000 miles, the owner must inspect all mounting points for cracks or fatigue, and check the fasteners for proper torque, according to the bolt torque requirements chart on the last page of these instructions.
- The owner must follow the vehicle manufacturer's instructions to prepare the vehicle for towing. Failure to do so may cause severe damage to the vehicle.
- This baseplate is only warranted for the original installation. Installing a used baseplate on another vehicle is not recommended and will void the warranty.



BASEPLATE KIT INSTALLATION INSTRUCTIONS

KIT# 523173-1

12/01/15
KS

ROADMASTER, Inc. 6110 NE 127th Ave. Vancouver, WA 98682 360-896-0407 fax 360-735-9300 www.roadmasterinc.com

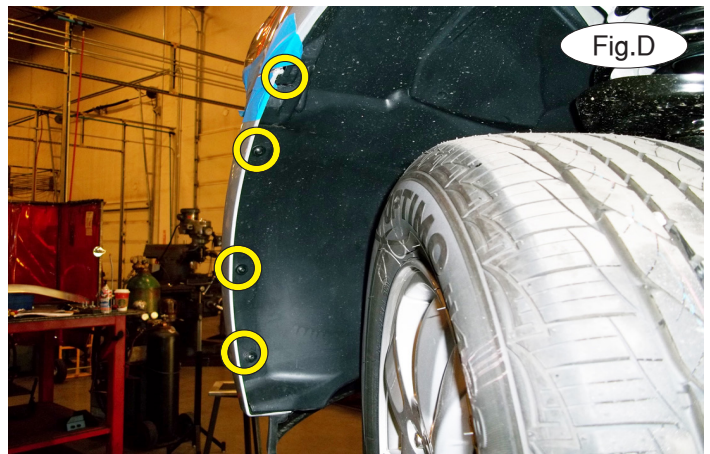
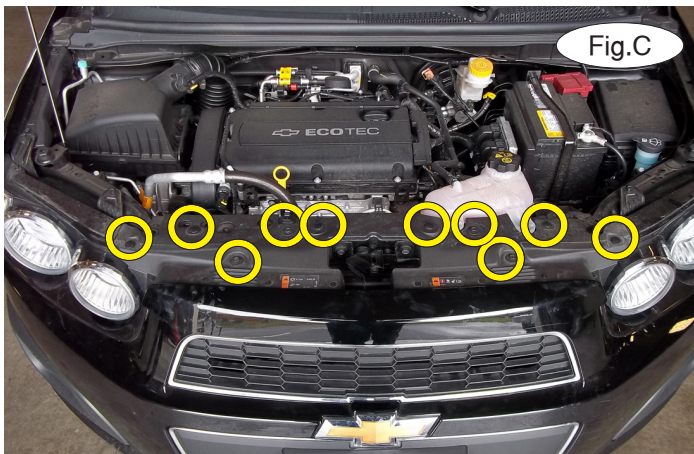

1. **Important:** please use all supplied bolts and parts and read all instructions carefully before beginning this installation. The majority of questions you may have can be answered within the text, and proper installation will ensure safe and secure travel. Now, begin the installation by removing six plastic fasteners and four 10mm (head) bolts attaching the top of the fascia to the core support (Fig.C).

2. On each side, remove four T20 Torx screws attaching the fascia to the fender liner (Fig.D).

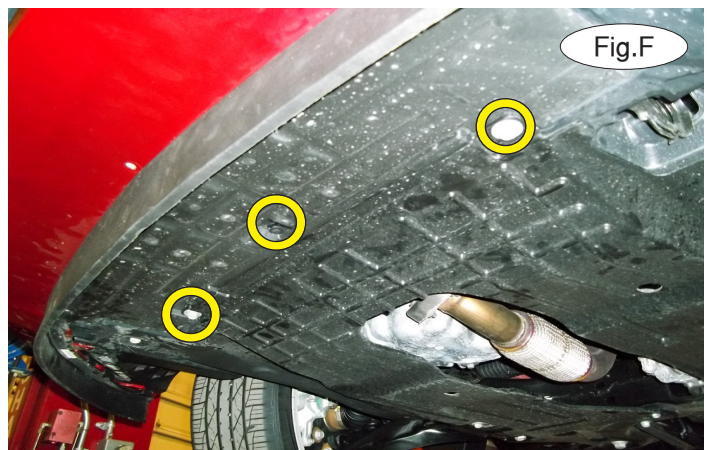
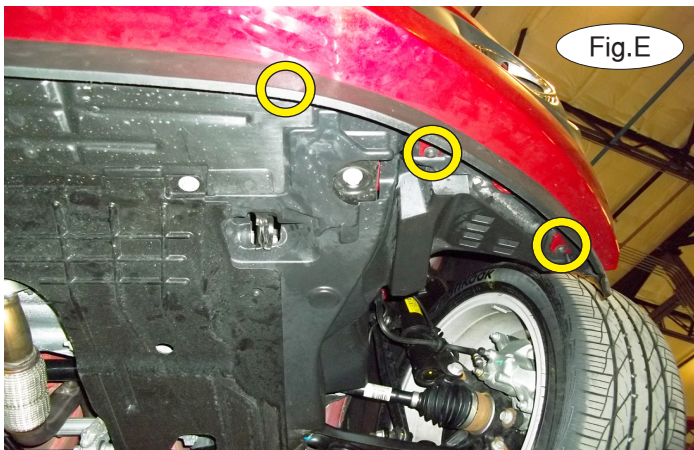

3. Remove seven T20 Torx screws attaching the splash shield to the fascia (Fig.E). *Note:* Figure E shows three of the seven fasteners.

4. Remove two 13mm (head) bolts and one plastic fastener attaching the splash shield to the core support (Fig.F).

5. Remove the splash shield, and remove two Philips screws attaching the bottom of the fascia to the core support (Fig.G).

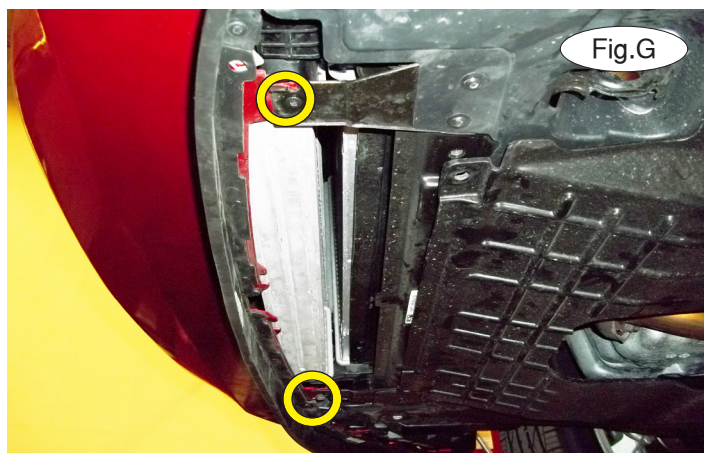



BASEPLATE KIT INSTALLATION INSTRUCTIONS

KIT# 523173-1

12/01/15
KS

ROADMASTER, Inc. 6110 NE 127th Ave. Vancouver, WA 98682 360-896-0407 fax 360-735-9300 www.roadmasterinc.com



Fig.H

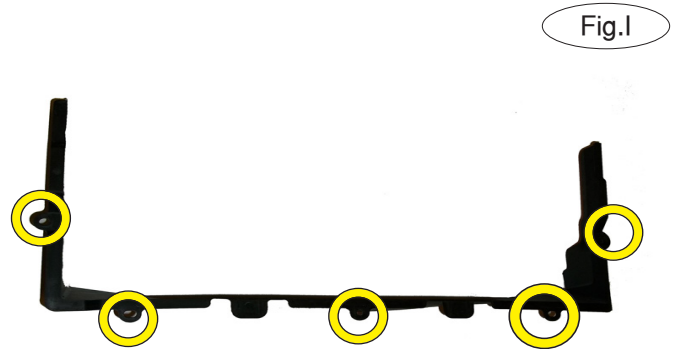

Fig.I

7. Pull out and forward on the corners of the fascia to remove it (Fig.H).
8. Remove the ambient temperature sensor and disconnect the fog lights, if the vehicle is so equipped.

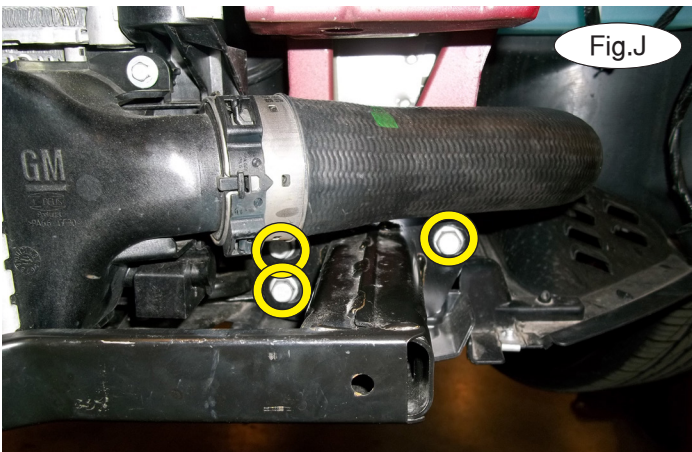

Fig.J

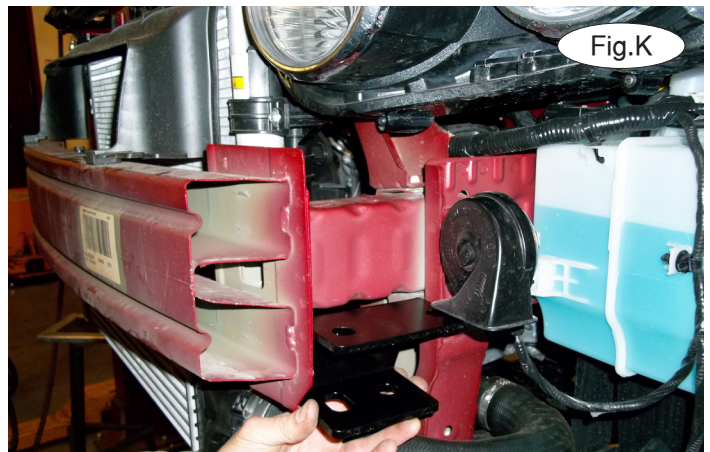

Fig.K

9. Due to manufacturing variances, the vehicle may be equipped with a plastic radiator liner. If this is the case, remove five plastic fasteners denoted with the yellow circles in Figure I. The radiator liner will not be replaced. *Note:* retain the radiator liner and attachment hardware for replacement in case the bracket is ever removed.

10. On each side, remove three 13mm (head) bolts to remove the lower bumper to the frame (Fig.J).

11. On each side, place the brace support between the bumper frame and the flange (Fig.K). Align the two upper holes of the brace support with the pre-existing holes in the bumper frame. Now, place one of the supplied 1/2" washers over one of the supplied 1/2" x 4 1/2" bolts, and bolt through the bumper frame and brace support. Finish with a 1/2" washer, lock washer and nut. The forwardmost bolt faces downward and the rearmost bolt faces upwards (Fig.L). *Note:* ensure proper alignment, as the bolts will receive Loctite® Red and will be torqued at the end of these instructions.

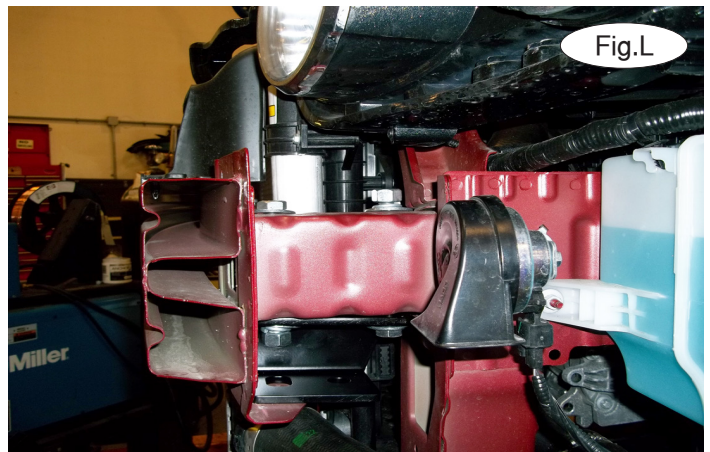

Fig.L



BASEPLATE KIT INSTALLATION INSTRUCTIONS

KIT# 523173-1

12/01/15
KS

ROADMASTER, Inc. 6110 NE 127th Ave. Vancouver, WA 98682 360-896-0407 fax 360-735-9300 www.roadmasterinc.com

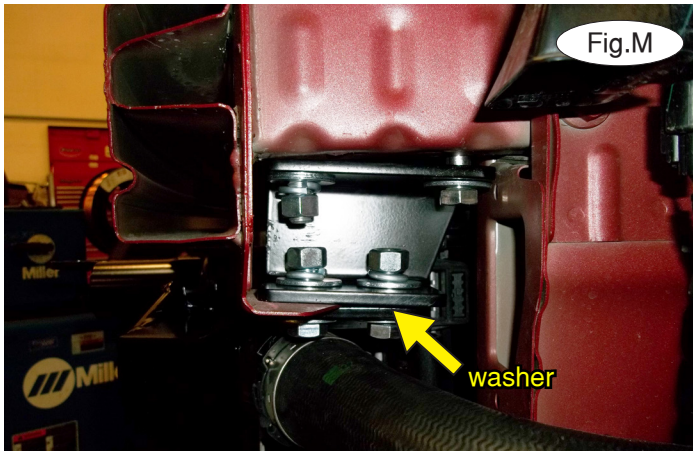

12. Place the main receiver brace under the bumper core to align with holes in the support brace. Then, on each side, place one $\frac{1}{2}$ " washer between the rear holes of the support brace and the main receiver brace as a spacer. Now, on each side, bolt the support brace to the main receiver brace using the two supplied $\frac{1}{2}$ " x $1\frac{1}{2}$ " bolts, four flat washers, and two lock washers and nuts (Fig.M).

13. Slide the lower bumper around the main receiver brace to reinstall it and replace the hardware you removed in step 10 (Fig.N).



14. Pull forward on the main receiver brace to remove the slack in the bolts (Fig.O). Now, tighten all bolts to the bolt torque requirements found at the end of these instructions. *Note:* use Loctite® Red on all nuts and bolts.

15. On each side, use a $\frac{1}{2}$ " drill bit to enlarge the pre-existing hole in the lower bumper (Fig.P).

16. On each side, bolt through the lower bumper and into to the main receiver brace using the supplied $\frac{1}{2}$ " x $3\frac{1}{2}$ " bolt and finish with a flat washer and lock washer (Fig.Q). Now, torque these bolts.

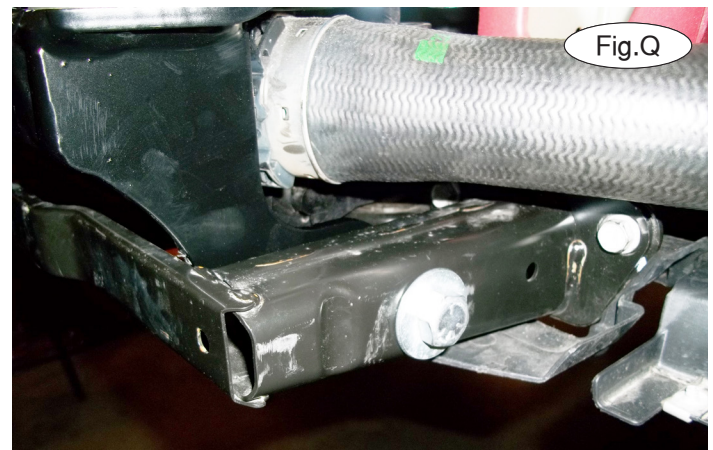



BASEPLATE KIT INSTALLATION INSTRUCTIONS

KIT# 523173-1

12/01/15
KS

ROADMASTER, Inc. 6110 NE 127th Ave. Vancouver, WA 98682 360-896-0407 fax 360-735-9300 www.roadmasterinc.com



17. Zip tie the ambient temperature sensor to the main receiver brace (Fig.R).

18. Hold the fascia in place over the main receiver brace and mark it for trimming. Trim the fascia as shown in Figure S to allow clearance for the main receiver brace. Use the yellow lines as a reference for trimming.

19. Reinstall the fascia, reversing steps 1 through 7.

20. Insert the removable front bracket arms into the front receiver braces, and twist each one 90 degrees to lock. Attach the 8" safety cables with the cable connectors (Q-Links) to the front of the receiver braces (Fig.T). *Note:* if your cables are long enough and can easily connect to the safety cable anchor built onto the main receiver brace, forego the use of the 8" cables included with this kit.

21. Attach the ends of the safety cables to the tow vehicle's safety cables and tow bar.

22. Install the tow bar to the mounting bracket according to the manufacturer's instructions.



Note: if the bracket is so equipped, the holes in the alignment tabs which are welded to the arms and main receiver braces are for padlocks only. Under no circumstances should you bolt the alignment tabs together. Bolting the alignment tabs together may result in non-warranty damage to the bracket.



BASEPLATE KIT INSTALLATION INSTRUCTIONS

KIT# 523173-1

12/01/15
KS

ROADMASTER, Inc. 6110 NE 127th Ave. Vancouver, WA 98682 360-896-0407 fax 360-735-9300 www.roadmasterinc.com

Three options for attaching the wiring plug to the main receiver brace

For six-wire plugs: use the two supplied 3/4" self-tapping screws to attach the electrical plug directly to the rods on the front of the main receiver brace.

For four-wire round plugs: attach to the plug mounting plate and then use the two supplied 3/4" self-tapping screws to attach the mounting plate to the rods on the front of the main receiver brace.

For four-wire flat plugs: place the plug through the mounting plug plate, and then secure it using the supplied zip tie on the front of the plug (Fig.U). Use the two supplied 3/4" self-tapping screws to attach the mounting plate to the rods on the front of the main receiver brace.

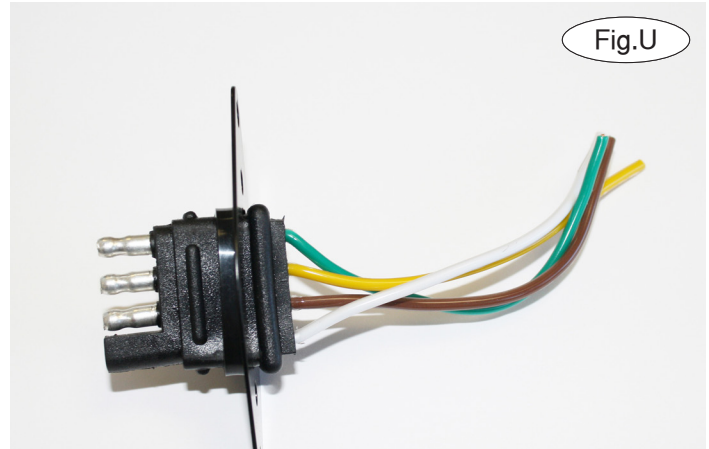

Fig.U

BOLT TORQUE REQUIREMENTS

Note: The torque values represented below are intended as general guidelines. Torque requirements for specific applications may vary. Roadmaster does not warrant this information to be accurate for all applications and disclaims all liability for any claims or damages which may result from its use.

STANDARD BOLTS

Thread Size	Grade	Torque
5/16.....	5.....	13 ft./lb.
3/8.....	5.....	23 ft./lb.
7/16.....	5.....	37 ft./lb.
1/2.....	5.....	56 ft./lb.
5/8.....	5.....	150 ft./lb.

METRIC BOLTS

Thread Size	Grade	Plated / Unplated
8mm-1.0	8.8	20 ft./lb. 18 ft./lb.
8mm-1.25	8.8	19 ft./lb. 18 ft./lb.
10mm-1.25	8.8	38 ft./lb. 36 ft./lb.
10mm-1.5	8.8	37 ft./lb. 35 ft./lb.

METRIC BOLTS

Thread Size	Grade	Plated / Unplated
12mm-1.25	8.8	70 ft./lb. 65 ft./lb.
12mm-1.5	8.8	66 ft./lb. 61 ft./lb.
12mm-1.75	8.8	65 ft./lb. 60 ft./lb.
14mm-2.0	8.8	104 ft./lb. 97 ft./lb.

All illustrations and specifications contained herein are based on the latest information available at the time of publication approval. ROADMASTER, INC. reserves the right to make changes at any time without notice in material, specification and models or to discontinue models.