



# BASEPLATE KIT INSTALLATION INSTRUCTIONS

**KIT# 523189-4**

12/25  
FC

ROADMASTER, Inc. 6110 NE 127th Ave. Vancouver, WA 98682 360-896-0407 fax 360-735-9300 www.roadmasterinc.com

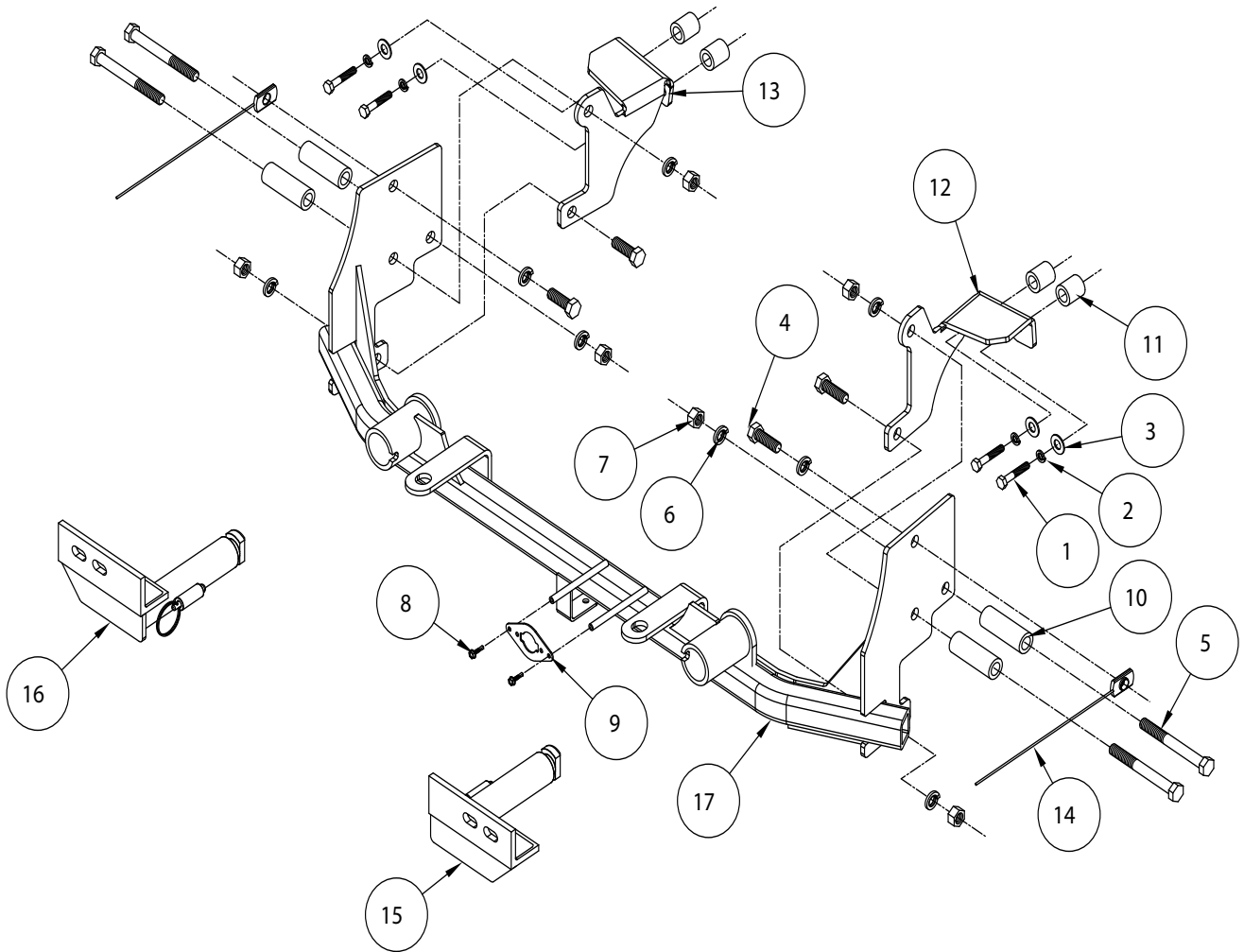

ITEM	QTY	MATERIAL	MATERIAL
1.....	4	8mm x 1.25 x 55 mm BOLT .....	356006-00
2.....	4	8mm LOCK WASHER.....	355705-00
3.....	4	5/16" FLAT WASHER.....	350302-00
4.....	4	1/2" x 1 1/2" BOLT .....	350095-00
5.....	4	1/2" x 4 1/2" BOLT .....	350106-00
6.....	8	1/2" LOCK WASHER .....	350309-00
7.....	6	1/2" HEX NUT .....	350258-00
8.....	2	#10 x 3/4" SELF DRILLING SCREW .....	350247-35
9.....	1	WIRE PLUG PLATE.....	A-003801
10.....	4	1" O.D. x 0.188 WALL x 2 7/8" PIPE SPACER .....	A-001047
11.....	4	1" O.D. x 0.188 WALL x 1 1/8" PIPE SPACER .....	A-002410
12.....	1	DRIVER SIDE BRACE.....	B-003190
13.....	1	PASSENGER SIDE BRACE .....	B-003191
14.....	2	1/2" WELD NUT BACKING PLATE WITH ROD.....	C-002820
15.....	1	DRIVER SIDE ARM .....	C-003083
16.....	1	PASSENGER SIDE ARM.....	C-003084
17.....	1	MAIN RECEIVER.....	C-003085



# BASEPLATE KIT INSTALLATION INSTRUCTIONS

**KIT# 523189-4**

12/25  
FC

ROADMASTER, Inc. 6110 NE 127th Ave. Vancouver, WA 98682 360-896-0407 fax 360-735-9300 www.roadmasterinc.com

This is one of our crossbar-style series, which allows the visible front portion of the baseplate to be easily removed from the front of the vehicle (Fig.A and Fig.B).

The kit consists of a main receiver brace, two removable front braces, and a hardware pack. All of these components mount to the framing.

Before starting the installation, lay out the kit components in order, as they will be used. This will give you a visual idea of how the components work, and will also confirm that everything is present and accounted for.



**IMPORTANT:** All baseplates **must** be assembled with all the bolts left loose for final adjustment and positioning (before tightening) unless otherwise instructed. All bolts **must** be torqued for proper strength. If more than one bolt is used per fastening point, the diagram may only show one. Use flat washers over all slotted holes and lock washers on all fasteners.

## WARNING

Failure to heed these warnings or follow the installation instructions may result in a voided warranty, loss of towed vehicle, personal injury or death.

- Do not weld or modify this baseplate or its components. Welding or modification will void the warranty.
- Do not use this document as a basis to design/fabricate a baseplate, as it may not show all parts or structural components.
- We strongly recommend professional installation.
- If the towed vehicle has been in an accident, it must be properly repaired before attaching the baseplate. Do not install the baseplate if any structural frame damage is found.
- The installer must use all bolts and parts supplied. If running changes were made by the vehicle manufacturer after this kit was designed, some bolts or other fasteners may no longer be the correct size. It is the installer's responsibility to verify this kit is securely fastened to the vehicle.
- Use Loctite® Red on all bolts used to secure this baseplate. Torque all bolts to the specifications found at the end of these instructions. Do not over-torque the bolts or failure may occur.
- The installer must inspect the baseplate to ensure adequate clearance, particularly around hoses, air conditioner lines, radiators, etc. or non-warranty failure may result.
- Roadmaster manufactures many styles of baseplates. If your baseplate has removable arms, they must be removed before driving the vehicle, unless the arms can be pinned or padlocked in place. If not secured, the arms could vibrate out.
- Some motorhome chassis have such a tight turning radius that you can damage your motorhome, towed vehicle, tow bar or baseplate while turning sharply. Before getting on the road, test your turning radius in an empty parking lot. Turning too sharply could result in non-warranty damage to your towing system, motorhome and/or towed vehicle.
- Do not back up with the towed vehicle attached or non-warranty damage will occur to your towing system or vehicles.
- The safety cables must connect the towing vehicle to the towed vehicle frame to frame, with the cables crossed, with enough slack for sharp turns. See cable instructions for proper routing. Failure to do so will result in non-warranty damage and/or the loss of the towed vehicle.
- This kit is designed for use with ROADMASTER tow bars and ROADMASTER adapters only. Using this kit with other brands, without an approved ROADMASTER adapter, may result in non-warranty damage or injury.
- Receiver extensions and out-of-level towing situations of 3 inches or more. This can cause the system to swing much higher and lower, causing excessive strain on the tow bar, baseplate and frame. That can cause the towing system to fail, causing property damage, personal injury or even death. If you must use a receiver extension or drop hitch to tow, it will reduce your receiver's weight capacity by 1/3 to avoid damaging your system. Never use more than one extension and/or drop hitch, as this will void your warranty.
- Every 3,000 miles, the owner must inspect all mounting points for cracks or fatigue, and check the fasteners for proper torque, according to the bolt torque requirements chart on the last page of these instructions.
- The owner must follow the vehicle manufacturer's instructions to prepare the vehicle for towing. Failure to do so may cause severe damage to the vehicle.
- This baseplate is only warranted for the original installation. Installing a used baseplate on another vehicle is not recommended and will void the warranty.



# BASEPLATE KIT INSTALLATION INSTRUCTIONS

**KIT# 523189-4**

12/25  
FC

ROADMASTER, Inc. 6110 NE 127th Ave. Vancouver, WA 98682 360-896-0407 fax 360-735-9300 www.roadmasterinc.com

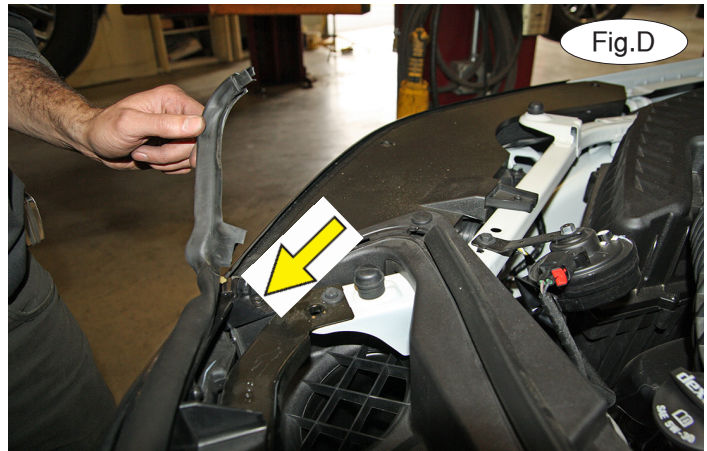

1. **Important:** please use all supplied bolts and parts and read all instructions carefully before beginning this installation. The majority of questions you may have can be answered within the text, and proper installation will ensure safe and secure travel. Now, begin the installation by removing seven T15 Torx screws attaching the top of the fascia to the core support (Fig.C). *Note:* it may be necessary to pull off the weather stripping to expose the screw on the passenger side corner (Fig.D).



2. On each side, remove four T15 Torx screws attaching the fender liner to the fascia (Fig.E).  
3. On each side, pull up on the bottom of the trim and then out to release the fasteners attaching the trim to the fascia (Fig.F). *Note:* it may be helpful to release the fasteners from behind the fascia and fender.  
4. Remove two 7mm (head) screws attaching the fascia to the splash shielding (Fig.G).

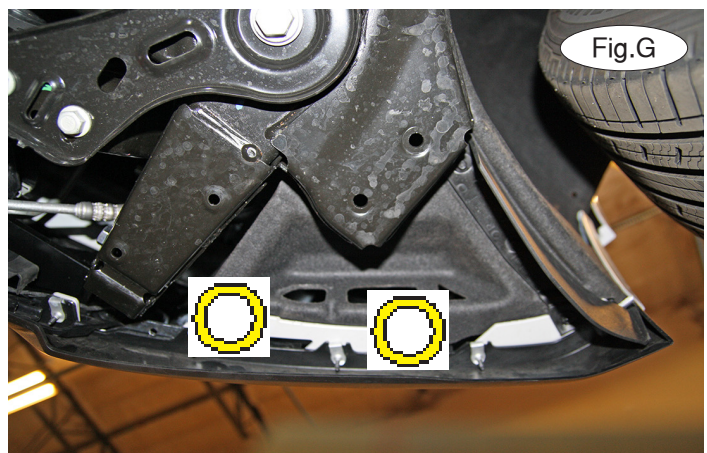



# BASEPLATE KIT INSTALLATION INSTRUCTIONS

**KIT# 523189-4**

12/25  
FC

ROADMASTER, Inc. 6110 NE 127th Ave. Vancouver, WA 98682 360-896-0407 fax 360-735-9300 www.roadmasterinc.com

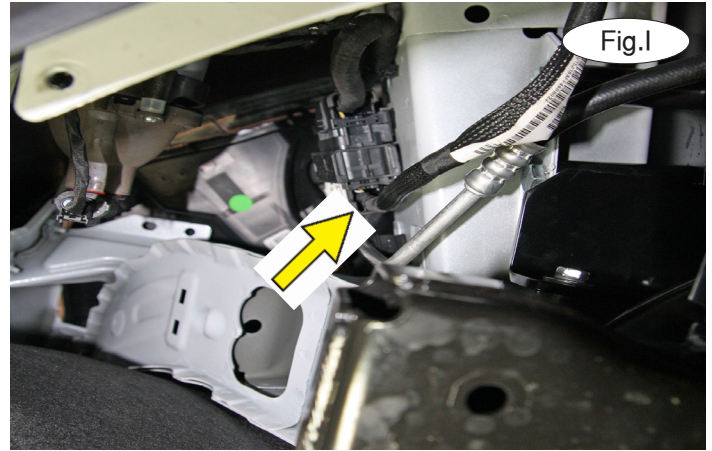

5. Remove two 7mm (head) screws attaching the bottom of the fascia to the core support (Fig.H).
6. On the passenger side only, release the red lock and pull on the white lever to unplug the wiring connector (Fig.I).
7. Due to manufacturing variances, it may be necessary to remove one 7mm (head) screw attaching the top corner of the fascia to the fender (Fig.J).

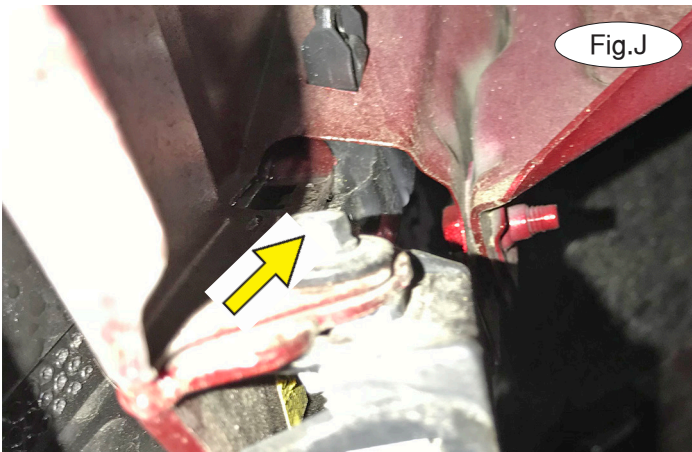

8. Pull out on the corners of the fascia to remove it (Fig.K).
9. On each side, remove the two 13mm (head) bolts attaching the subframe to the frame (Fig.L).

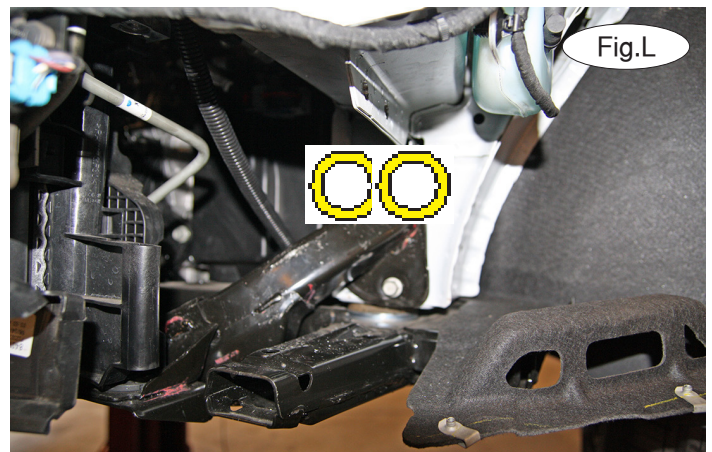



# BASEPLATE KIT INSTALLATION INSTRUCTIONS

**KIT# 523189-4**

12/25  
FC

ROADMASTER, Inc. 6110 NE 127th Ave. Vancouver, WA 98682 360-896-0407 fax 360-735-9300 www.roadmasterinc.com

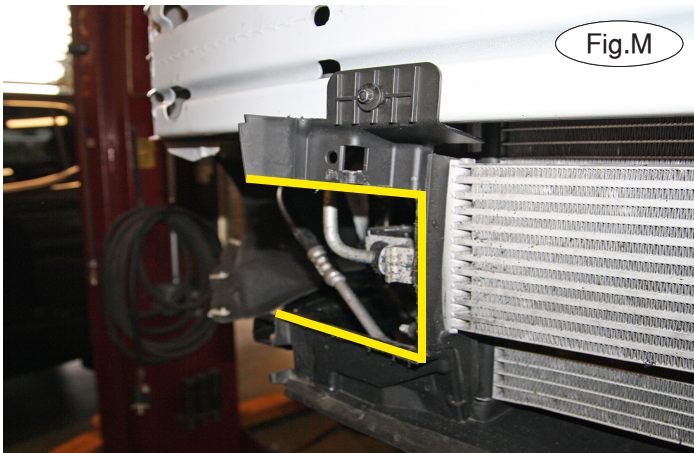

Fig.M

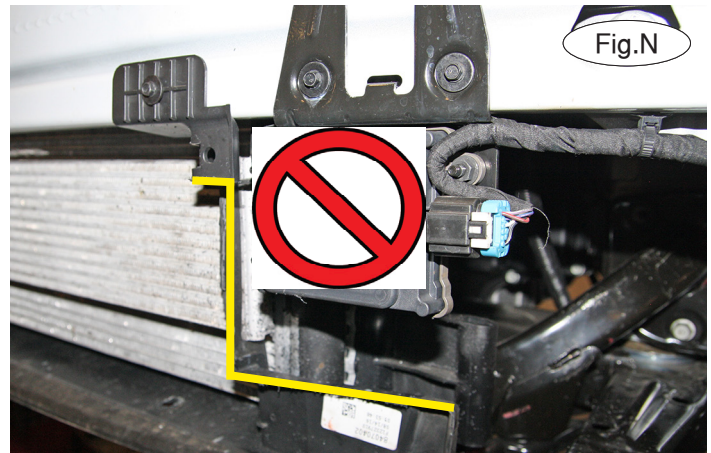

Fig.N

10. On each side, trim or remove the air deflectors to allow clearance for the main receiver brace. If you are trimming, use the yellow lines as a reference in Figure M (passenger side) and Figure N (driver's side). **Caution! Under no circumstances should you attempt to move, adjust or disconnect the ACC unit (Fig.N). Doing so may cause cruise control malfunction and/or computer error codes that may require the dealership to repair or reset.**

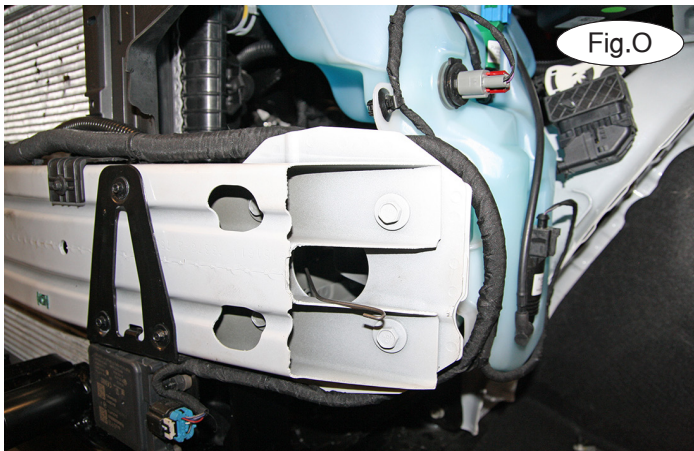

Fig.O



Fig.P

11. Place the main receiver brace under the bumper core and slide up between the frame and align it with the upper existing hole on the inside of the frame. **Note: due to manufacturing variances, be sure at this point that no part of the baseplate is – or is close to – making contact with any oil or transmission coolers and their associated coolant lines.** If the baseplate is not contacting the cooling lines or the radiator, on each side, use a 1/2" lock washer and 1/2" x 1 1/2" bolt to bolt through the main receiver brace and the frame, and thread it onto one of the 1/2" tab weld nuts with 10" wire that you place through the hole in the front of the bumper core (Fig.O and Fig.P). **Note:** ensure proper alignment, as the bolts will receive Loctite® Red and will be torqued at the end of these instructions.

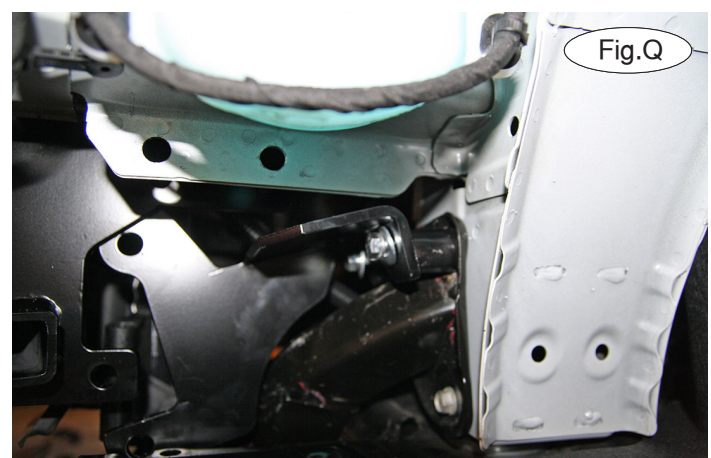

Fig.Q

12. On each side, place the rear support brace over the holes you exposed in step 9, on the inside of the main receiver mount. For each mount, place one of the 1-1/8" pipe spacers between the rear support brace and the frame. Then, for each mount, use a 8mm x 1.25 x 55mm bolt, 8mm lock washer and 5/16" flat washer and bolt through the pipe spacer and the frame (Fig.Q).



# BASEPLATE KIT INSTALLATION INSTRUCTIONS

**KIT# 523189-4**

12/25  
FC

ROADMASTER, Inc. 6110 NE 127th Ave. Vancouver, WA 98682 360-896-0407 fax 360-735-9300 www.roadmasterinc.com

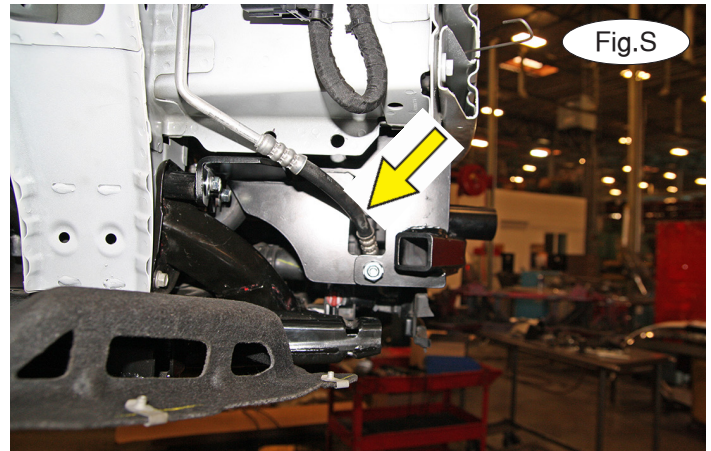
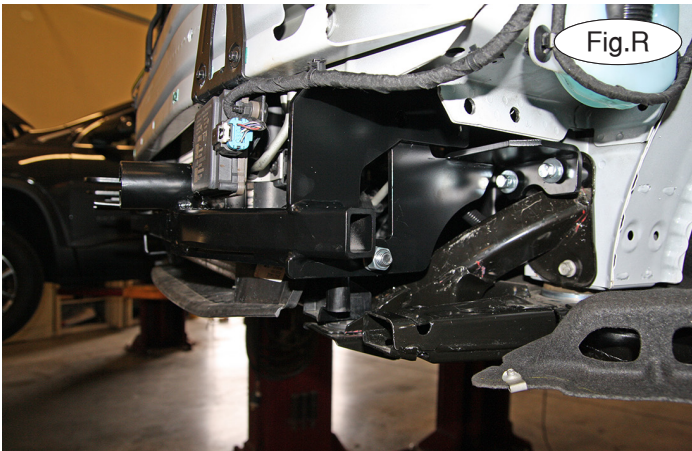

13. On each side, bolt the rear support brace to the main receiver brace using a  $\frac{1}{2}$ " x  $1\frac{1}{2}$ " bolt,  $\frac{1}{2}$ " lock washer and nut (Fig.R). *Note:* on the passenger side, ensure that the cooling line is not impeded in any way. If it is touching the main receiver brace, bend it carefully out of the way (Fig.S).

14. Ensure the main receiver brace is level before proceeding to the next step.

15. On the driver's side only, remove two 10mm (head) bolts attaching the washer bottle to the frame to allow access for drilling in the next step (Fig.T). Secure the washer bottle away from the frame for now. *Note:* it may be necessary to undo one or more wiring harness clips in order to accomplish this.

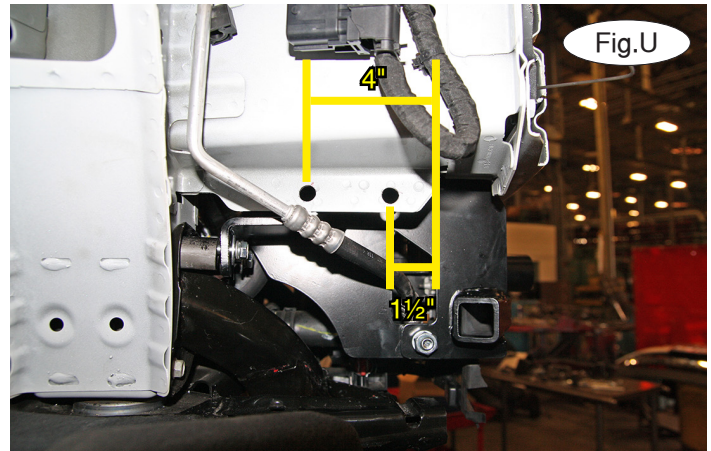
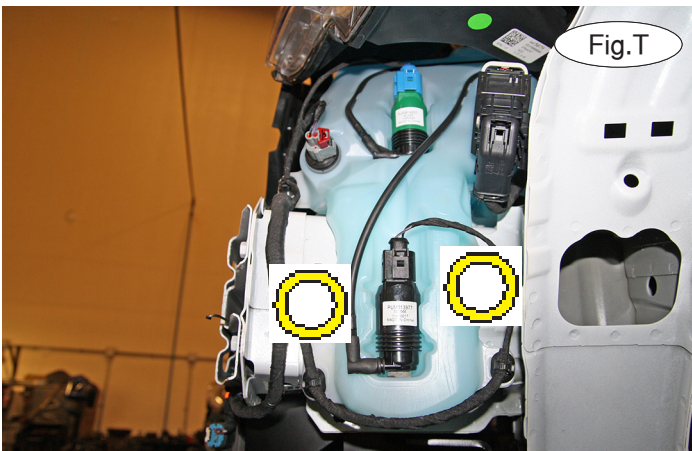

16. On each side, measure  $1\frac{1}{2}$ " and 4" back from the forward edge of the pinch weld, centered vertically, and mark two holes on the pinch weld for drilling (Fig.U). Use a  $\frac{1}{2}$ " drill to drill out the two holes on each side, drilling straight through the pinch weld. *Note:* due to manufacturing variances, the exact position may vary. The holes must be aligned with the mounting holes of the main receiver brace.

17. On each side, place two of the 2-7/8" pipe spacers between the pinch weld and the main receiver brace, aligning them with the holes you just drilled in the previous step. Then, bolt through each one using a  $\frac{1}{2}$ " x  $4\frac{1}{2}$ " bolt and finish with a  $\frac{1}{2}$ " lock washer and nut (Fig.V).

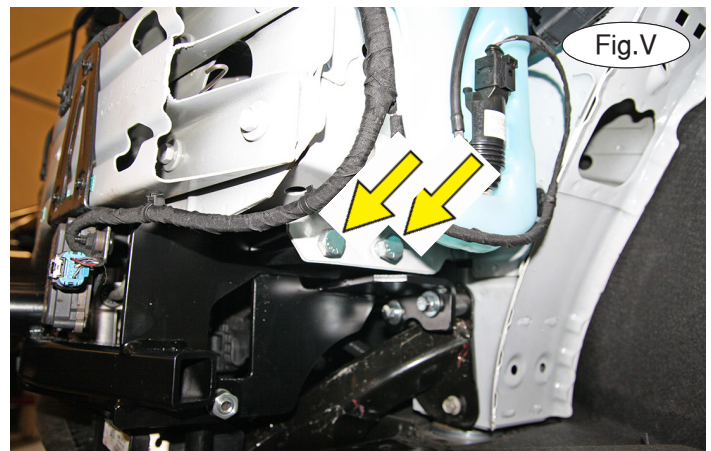



# BASEPLATE KIT INSTALLATION INSTRUCTIONS

**KIT# 523189-4**

12/25  
FC

ROADMASTER, Inc. 6110 NE 127th Ave. Vancouver, WA 98682 360-896-0407 fax 360-735-9300 www.roadmasterinc.com

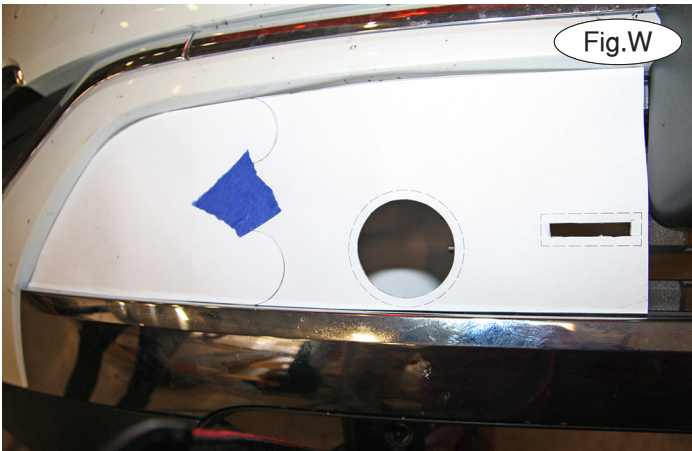

18. Cut out the template at the end of these instructions, aligning the curved lines. Tape the two pieces together and then lay it over the front of the grille, aligning the edges of the template with the edges of the fascia (Fig.W). Mark the hole and then trim the fascia to allow clearance for the main receiver brace and safety cable tabs. Figure X shows the completed trimming.

19. Torque all bolts to the bolt torque specifications found at the end of these instructions. *Note:* use Loctite® Red on all nuts and bolts. Reinstall the fascia, reversing steps 1 through 8.

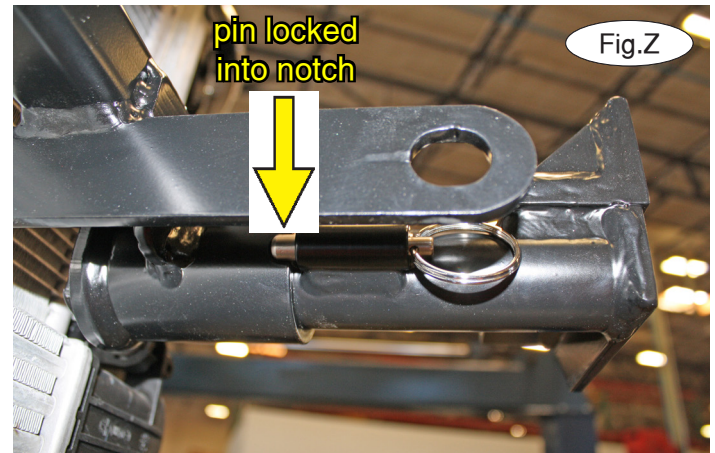
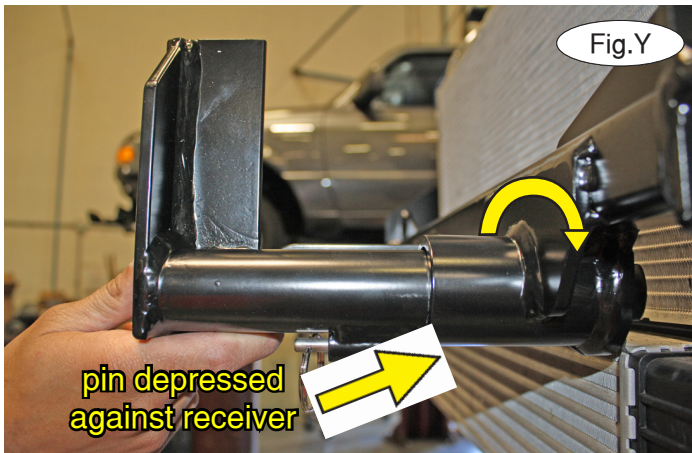

20. *Note: the following four images are for illustration purposes only, as your specific application may be slightly different.*

On each side, insert the removable front bracket arm into the front receiver 90 degrees from its final towing position, depressing the spring-loaded pin against the receiver (Fig.Y). Now, twist back 90 degrees until the spring-loaded pin snaps into place in the notch on the receiver, locking the arm into place in its final towing position (Fig.Z).

**Please note: it is the owner's responsibility to ensure the locking of the pins before towing. Otherwise, failure of the towing system will result.**

21. Install the tow bar to the mounting bracket according to the manufacturer's instructions.



# BASEPLATE KIT INSTALLATION INSTRUCTIONS

**KIT# 523189-4**

12/25  
FC

ROADMASTER, Inc. 6110 NE 127th Ave. Vancouver, WA 98682 360-896-0407 fax 360-735-9300 www.roadmasterinc.com

### IMPORTANT!

Safety cables are required by law. When towing, connect safety cables to the safety cable tabs shown in Figure AA. Make certain there is adequate slack in the cables to allow a full turning radius; otherwise, damage will result. If necessary, longer cables or cable extensions are available.

Note: if the bracket is so equipped, the holes in the alignment tabs which are welded to the arms and main receiver braces are for padlocks only. Under no circumstances should you bolt the alignment tabs together. Bolting the alignment tabs together may result in non-warranty damage to the bracket.

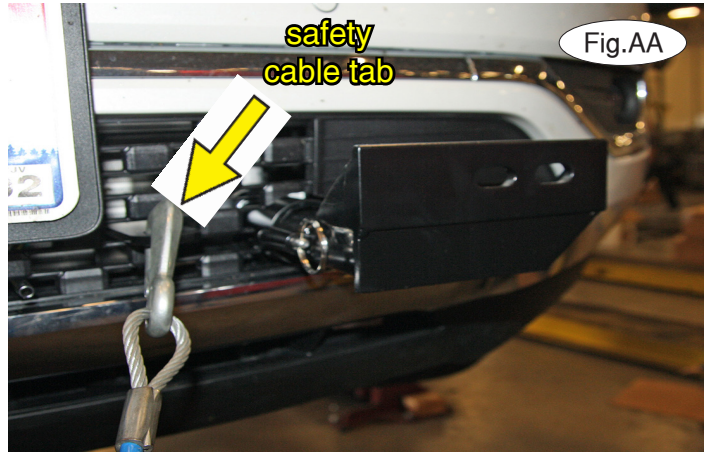

### Three options for attaching the wiring plug to the main receiver brace

**For six-wire plugs:** use the two supplied 3/4" self-tapping screws to attach the electrical plug directly to the rods on the front of the main receiver brace.

**For four-wire round plugs:** attach to the plug mounting plate and then use the two supplied 3/4" self-tapping screws to attach the mounting plate to the rods on the front of the main receiver brace.

**For four-wire flat plugs:** place the plug through the mounting plug plate, and then secure it using the supplied zip tie on the front of the plug (Fig.BB). Use the two supplied 3/4" self-tapping screws to attach the mounting plate to the rods on the front of the main receiver brace.

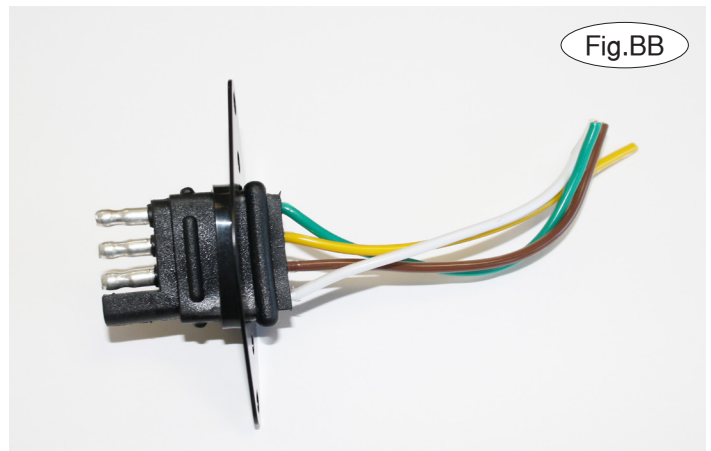

### BOLT TORQUE REQUIREMENTS

Note: The torque values represented below are intended as general guidelines. Torque requirements for specific applications may vary. Roadmaster does not warrant this information to be accurate for all applications and disclaims all liability for any claims or damages which may result from its use.

#### STANDARD BOLTS

Thread Size	Grade	Torque
3/8.....	5.....	13 ft./lb.
3/8.....	5.....	23 ft./lb.
7/16.....	5.....	37 ft./lb.
1/2.....	5.....	56 ft./lb.
5/8.....	5.....	150 ft./lb.

#### METRIC BOLTS

Thread Size	Grade	Plated / Unplated
8mm-1.0.....	8.8.....	20 ft./lb. 18 ft./lb.
8mm-1.25.....	8.8.....	19 ft./lb. 18 ft./lb.
10mm-1.25.....	8.8.....	38 ft./lb. 36 ft./lb.
10mm-1.5.....	8.8.....	37 ft./lb. 35 ft./lb.

#### METRIC BOLTS

Thread Size	Grade	Plated / Unplated
12mm-1.25.....	8.8.....	70 ft./lb. 65 ft./lb.
12mm-1.5.....	8.8.....	66 ft./lb. 61 ft./lb.
12mm-1.75.....	8.8.....	65 ft./lb. 60 ft./lb.
14mm-2.0.....	8.8.....	104 ft./lb. 97 ft./lb.

All illustrations and specifications contained herein are based on the latest information available at the time of publication approval. ROADMASTER, INC. reserves the right to make changes at any time without notice in material, specification and models or to discontinue models.

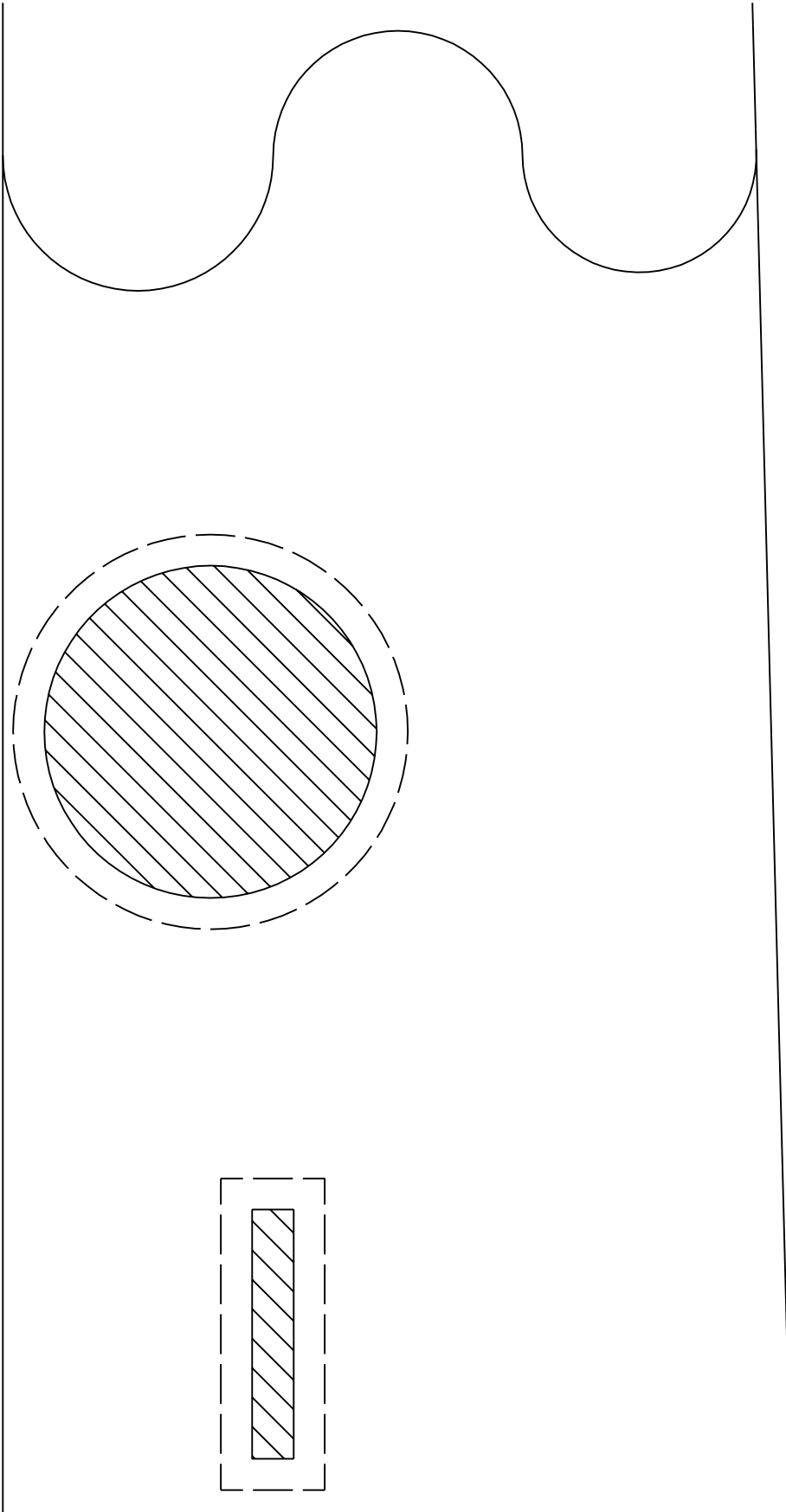

*Driver's side  
and passenger  
side trimming  
template  
(part 1 of 2)*

*this page is intentionally blank to allow for  
template printing*

*Driver's side  
and passenger  
side trimming  
template  
(part 2 of 2)*

