



BASEPLATE KIT INSTALLATION INSTRUCTIONS

KIT# 523202-5

02/21/22
KS

ROADMASTER, Inc. 6110 NE 127th Ave. Vancouver, WA 98682 360-896-0407 fax 360-735-9300 www.roadmasterinc.com

Important
Note: This baseplate will not accommodate the Guardian rock shield, some models of the Tow Defender, or any StowMaster tow bar.

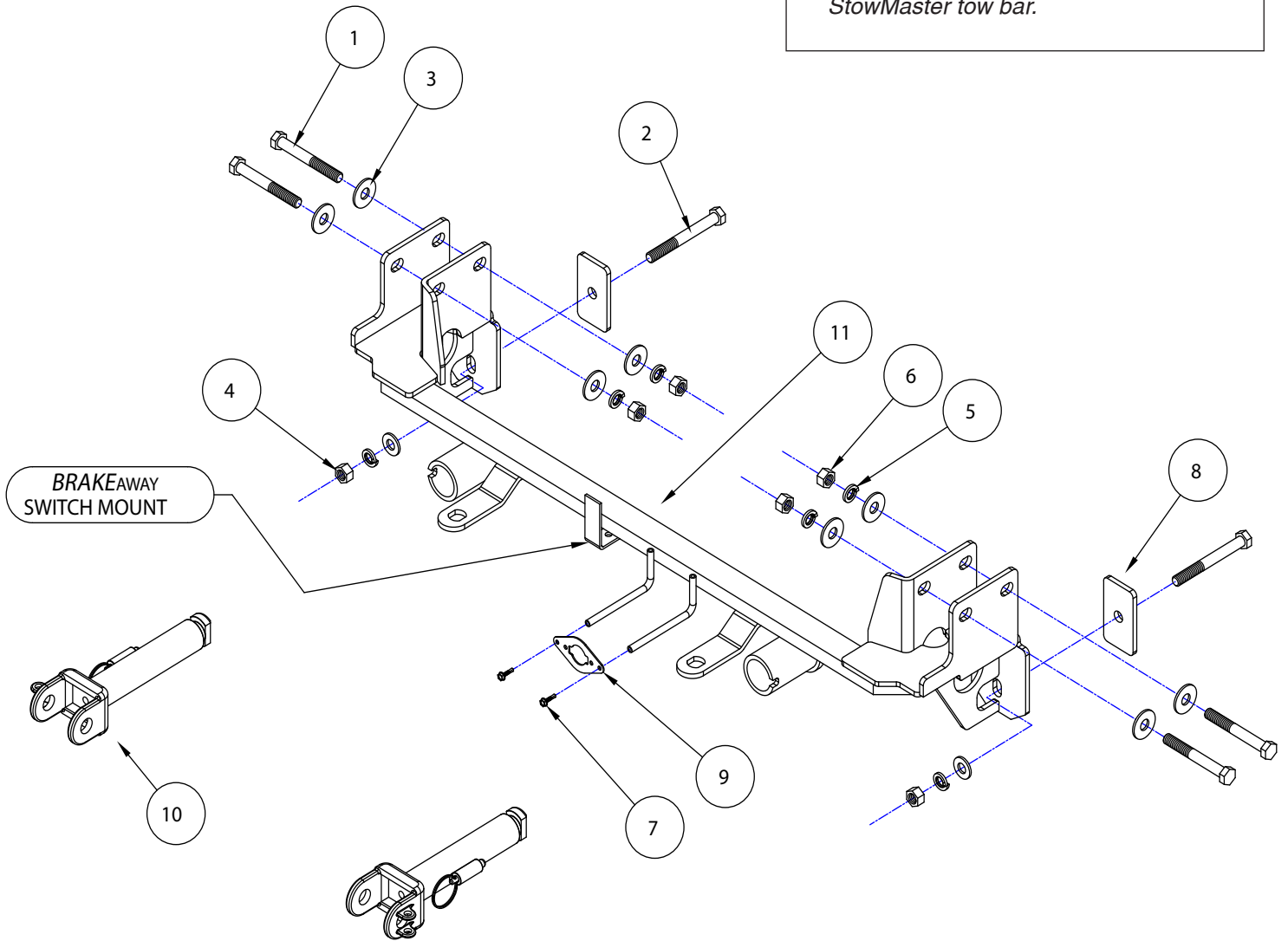

ITEM	QTY	NAME	MATERIAL
1.....	4.....	1/2" x 4" BOLT	350105-00
2.....	2.....	1/2" x 4 1/2" BOLT	350106-00
3.....	8.....	1/2" FLAT WASHER.....	350308-00
4.....	2.....	1/2" FLAT WASHER SAE.....	350308-20
5.....	6.....	1/2" LOCK WASHER.....	350309-00
6.....	6.....	1/2" NUT.....	350258-00
7.....	2.....	#10 x 3/4" SELF DRILLING SCREW	350247-35
8.....	2.....	2" x 3 1/2" BACKING PLATE.....	A000165
9.....	1.....	WIRE PLUG PLATE	A003801
10.....	2.....	ARM	C002383
11.....	1.....	RECEIVER BRACE.....	C003462



BASEPLATE KIT INSTALLATION INSTRUCTIONS

KIT# 523202-5

02/21/22
KS

ROADMASTER, Inc. 6110 NE 127th Ave. Vancouver, WA 98682 360-896-0407 fax 360-735-9300 www.roadmasterinc.com

This is one of our direct-connect baseplates, which allows the visible front portion to be easily removed from the front of the vehicle (Fig.A and Fig.B).

The baseplate mounts to the frame of the vehicle and consists of two main receiver braces, two removable front braces, and a hardware pack.

Before starting the installation, lay out the kit components in order, as they will be used. This will give you a visual idea of how the components work, and will also confirm that everything is present and accounted for.



IMPORTANT: All baseplates **must** be assembled with all the bolts left loose for final adjustment and positioning (before tightening) unless otherwise instructed. All bolts **must** be torqued for proper strength. If more than one bolt is used per fastening point, the diagram may only show one. Use flat washers over all slotted holes and lock washers on all fasteners.

WARNING

Failure to heed these warnings or follow the installation instructions may result in a voided warranty, loss of towed vehicle, personal injury or death.

- Do not weld or modify this baseplate or its components. Welding or modification will void the warranty.
- Do not use this document as a basis to design/fabricate a baseplate, as it may not show all parts or structural components.
- We strongly recommend professional installation.
- If the towed vehicle has been in an accident, it must be properly repaired before attaching the baseplate. Do not install the baseplate if any structural frame damage is found.
- The installer must use all bolts and parts supplied. If running changes were made by the vehicle manufacturer after this kit was designed, some bolts or other fasteners may no longer be the correct size. It is the installer's responsibility to verify this kit is securely fastened to the vehicle.
- Use Loctite® Red on all bolts used to secure this baseplate. Torque all bolts to the specifications found at the end of these instructions. Do not over-torque the bolts or failure may occur.
- The installer must inspect the baseplate to ensure adequate clearance, particularly around hoses, air conditioner lines, radiators, etc. or non-warranty failure may result.
- Roadmaster manufactures many styles of baseplates. If your baseplate has removable arms, they must be removed before driving the vehicle, unless the arms can be pinned or padlocked in place. If not secured, the arms could vibrate out.
- Some motorhome chassis have such a tight turning radius that you can damage your motorhome, towed vehicle, tow bar or baseplate while turning sharply. Before getting on the road, test your turning radius in an empty parking lot. Turning too sharply could result in non-warranty damage to your towing system, motorhome and/or towed vehicle.
- Do not back up with the towed vehicle attached or non-warranty damage will occur to your towing system or vehicles.
- The safety cables must connect the towing vehicle to the towed vehicle frame to frame, with the cables crossed, with enough slack for sharp turns. See cable instructions for proper routing. Failure to do so will result in non-warranty damage and/or the loss of the towed vehicle.
- This kit is designed for use with ROADMASTER tow bars and ROADMASTER adapters only. Using this kit with other brands, without an approved ROADMASTER adapter, may result in non-warranty damage or injury.
- Receiver extensions and out-of-level towing situations of 3 inches or more. This can cause the system to swing much higher and lower, causing excessive strain on the tow bar, baseplate and frame. That can cause the towing system to fail, causing property damage, personal injury or even death. If you must use a receiver extension or drop hitch to tow, it will reduce your receiver's weight capacity by 1/3 to avoid damaging your system. Never use more than one extension and/or drop hitch, as this will void your warranty.
- Every 3,000 miles, the owner must inspect all mounting points for cracks or fatigue, and check the fasteners for proper torque, according to the bolt torque requirements chart on the last page of these instructions.
- The owner must follow the vehicle manufacturer's instructions to prepare the vehicle for towing. Failure to do so may cause severe damage to the vehicle.
- This baseplate is only warranted for the original installation. Installing a used baseplate on another vehicle is not recommended and will void the warranty.



BASEPLATE KIT INSTALLATION INSTRUCTIONS

KIT# 523202-5

02/21/22
KS

ROADMASTER, Inc. 6110 NE 127th Ave. Vancouver, WA 98682 360-896-0407 fax 360-735-9300 www.roadmasterinc.com



1. **Important:** please use all supplied bolts and parts and read all instructions carefully before beginning this installation. The majority of questions you may have can be answered within the text, and proper installation will ensure safe and secure travel. On each side, remove two 10mm bolts and one plastic fastener attaching the top of the fascia to the radiator support (Fig.C). *Note:* Activ models only have one 10mm bolt.

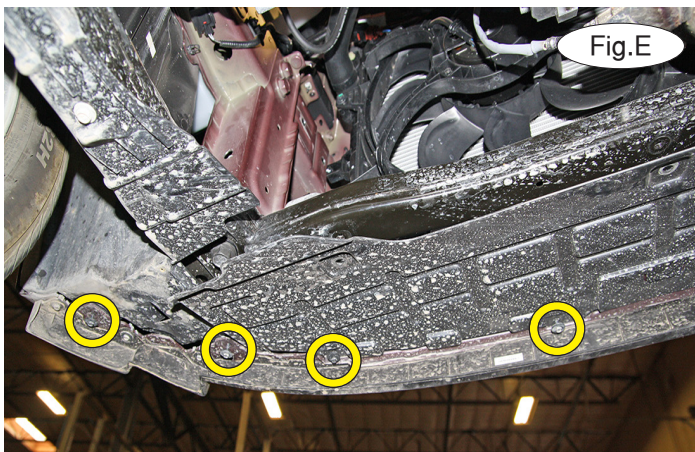

2. Remove three 10mm bolts attaching the splash shield to the subframe (Fig.D). *Note:* Due to manufacturing variances, the bolts may be 13mm instead.

3. On each side, remove four 7mm screws attaching the splash shield and fender liner to the fascia (Fig.E). Pull toward the rear of the vehicle to remove the splash shield. Set it aside for now.

4. On each side, remove two plastic fasteners attaching the fender liner to the fascia (Fig.F).

5. On each side, pull back the fender liner and remove one 7mm screw attaching the top corner of the fascia to the fender (Fig.G).

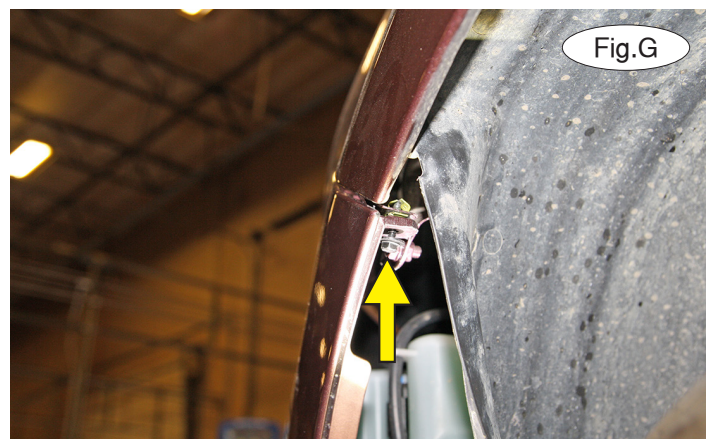



BASEPLATE KIT INSTALLATION INSTRUCTIONS

KIT# 523202-5

02/21/22
KS

ROADMASTER, Inc. 6110 NE 127th Ave. Vancouver, WA 98682 360-896-0407 fax 360-735-9300 www.roadmasterinc.com

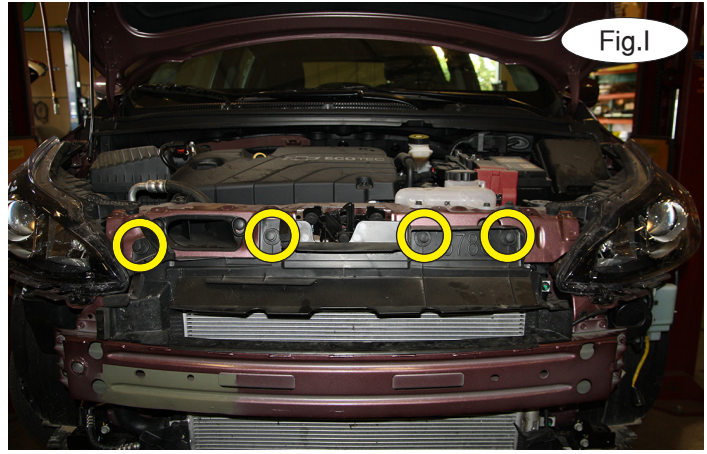
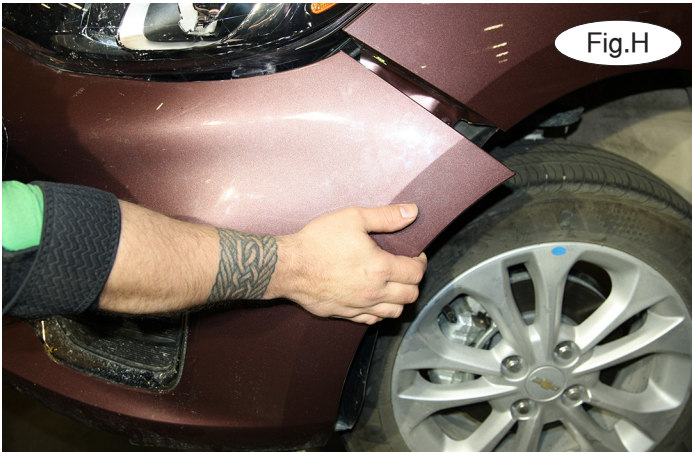

6. Pull out on the corners of the fascia to release the locking tabs under the headlights. Then, pull straight out to remove the fascia (Fig.H), disconnecting any wiring harnesses. Set the fascia aside for now.

7. Remove four plastic fasteners attaching the upper air dam to the radiator support (Fig.I).

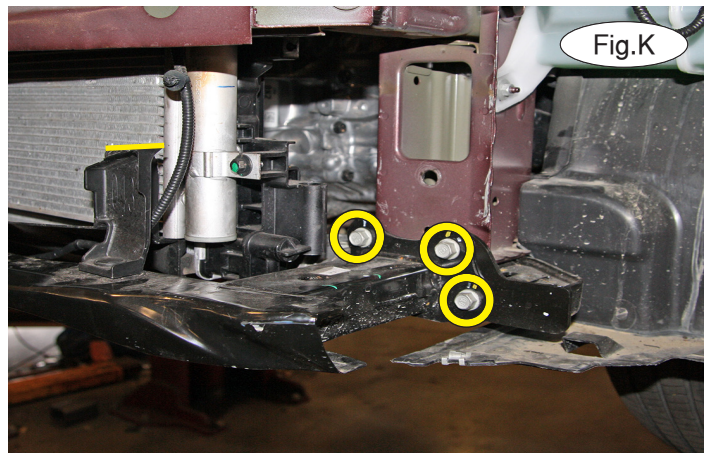
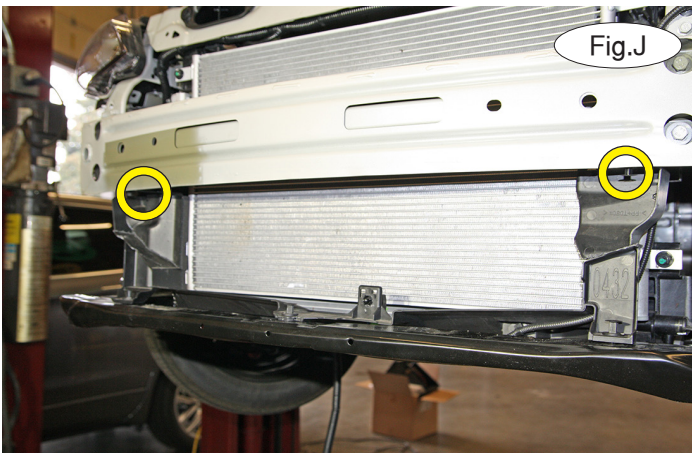

8. On each side, remove one plastic fastener attaching the upper part of the lower air dam to the bottom of the bumper core (Fig.J – yellow circles).

9. On each side, trim the air dam as shown (Fig.K – yellow line). Remove three 13mm bolts attaching the lower grille support to the subframe (Fig.K – circles). Turn the assembly over and disconnect the ambient temperature sensor and wiring harness (Fig.L). Set it aside for now.

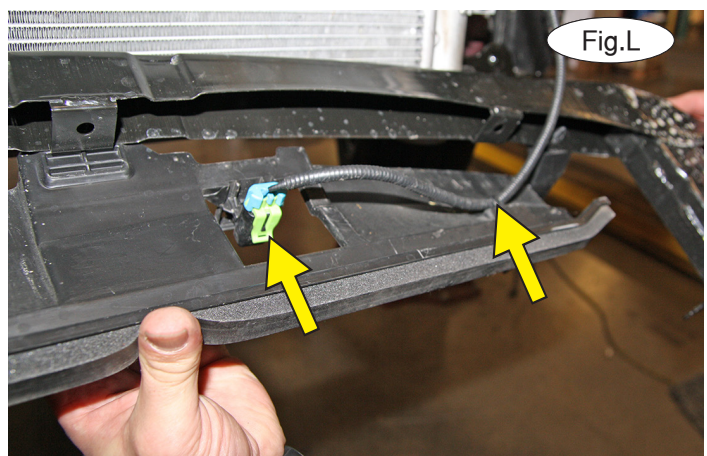



BASEPLATE KIT INSTALLATION INSTRUCTIONS

KIT# 523202-5

02/21/22
KS

ROADMASTER, Inc. 6110 NE 127th Ave. Vancouver, WA 98682 360-896-0407 fax 360-735-9300 www.roadmasterinc.com

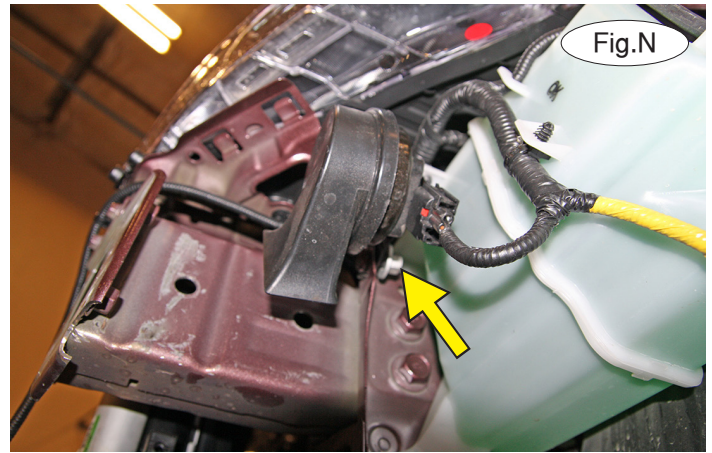
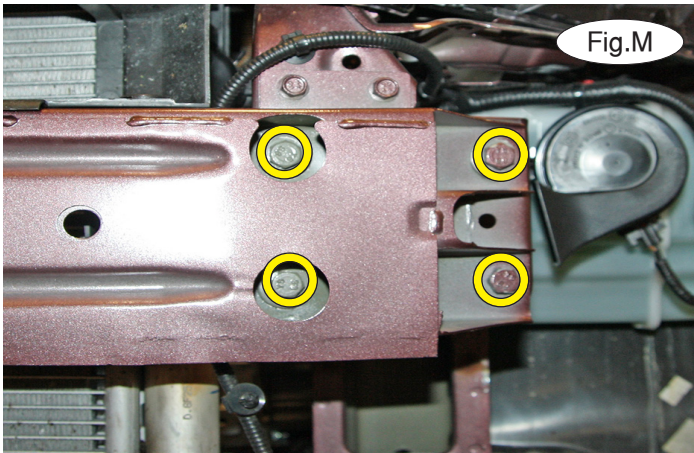

10. On each side, remove four 13mm bolts attaching the bumper core to the frame (Fig.M). Pull out to remove it and the upper air dam and set them aside for now. *Note:* Due to manufacturing variances, the bolts might be a different size.

11. On the driver's side only, remove one 13mm nut attaching the horn to the frame (Fig.N). Let it hang down.

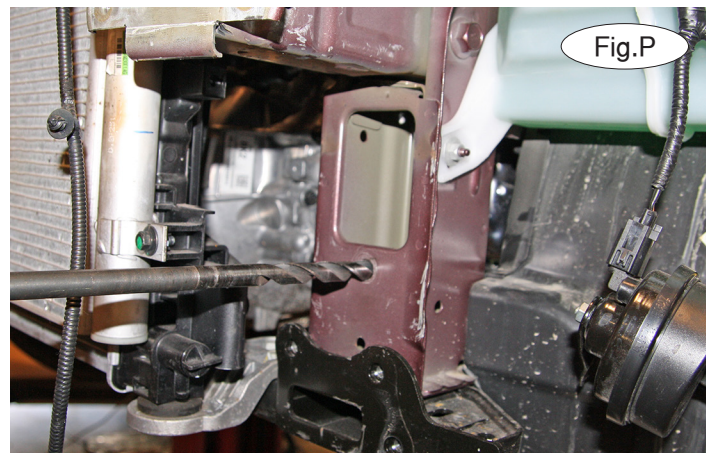
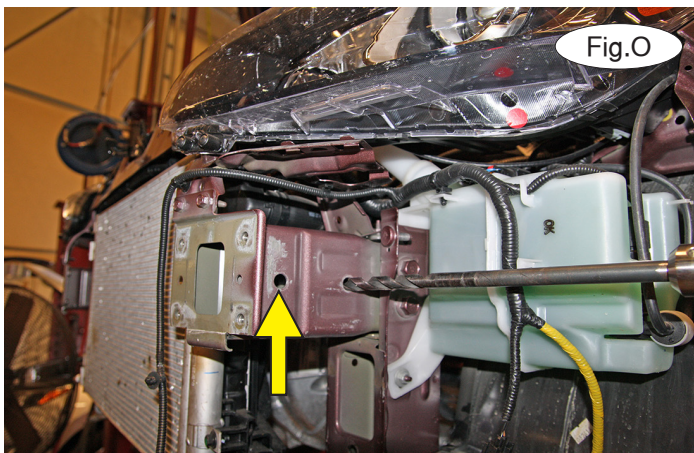

12. On each side, locate the two factory holes in the frame rail and use a $\frac{1}{2}$ " drill bit to enlarge the holes on both sides of the frame (Fig.O). *Note:* Use care to ensure that you do not drill into engine components on the other side of the frame rail.

13. On each side, locate the hole directly below the opening in the lower frame and – using the $\frac{1}{2}$ " drill – drill through the front and back of the frame (Fig.P).

14. On each side, cut out a $\frac{9}{16}$ " x 1" rectangular notch on each bottom corner of the bumper core mount (Fig.Q).

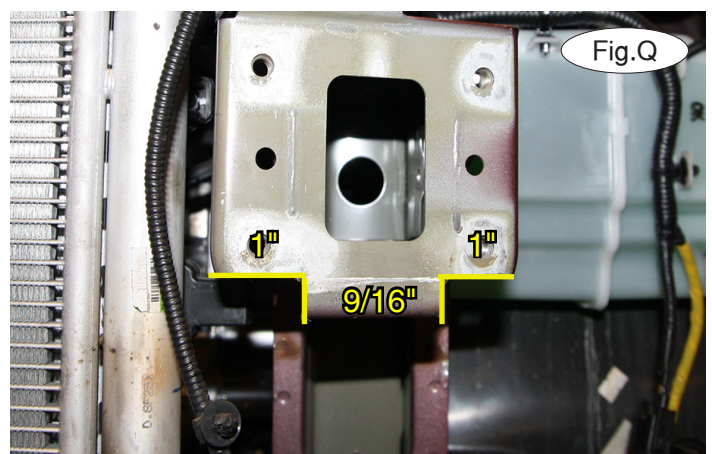



BASEPLATE KIT INSTALLATION INSTRUCTIONS

KIT# 523202-5

02/21/22
KS

ROADMASTER, Inc. 6110 NE 127th Ave. Vancouver, WA 98682 360-896-0407 fax 360-735-9300 www.roadmasterinc.com

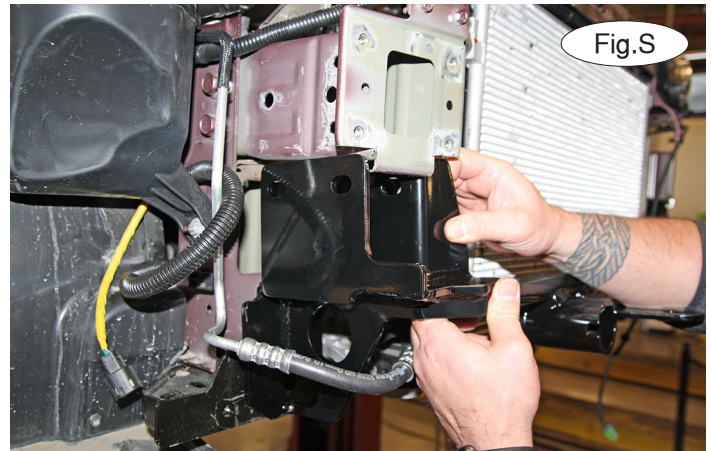
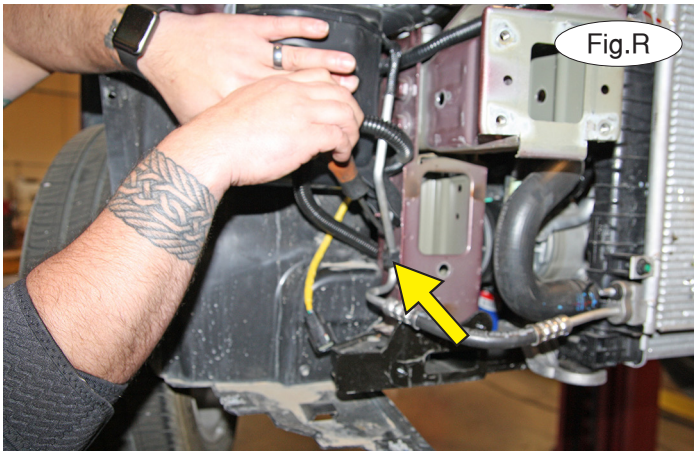

15. On the driver's side only, unclip the plastic fastener attaching the air conditioning line to the frame (Fig.R).

16. With the assistance of another person, maneuver the main receiver brace over the air conditioning line and under the frame rail on the passenger side (Fig.S). On the driver's side, you will need to place it under the frame only. *Note:* Before proceeding, ensure that the radiator hose is nestled into the half-moon cutout so it is not contacting the passenger side of the brace before proceeding (Fig.T).

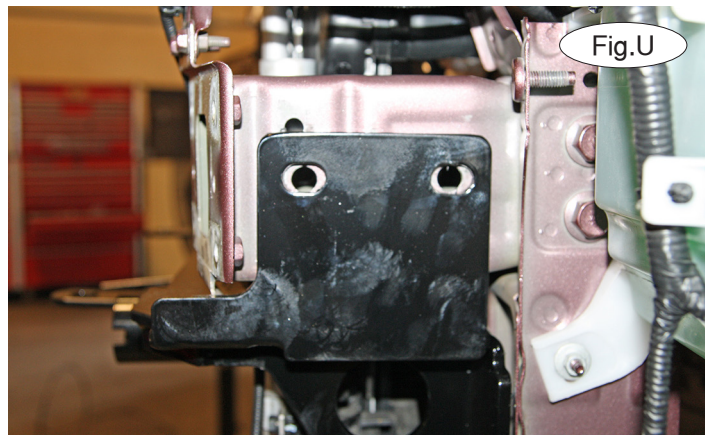
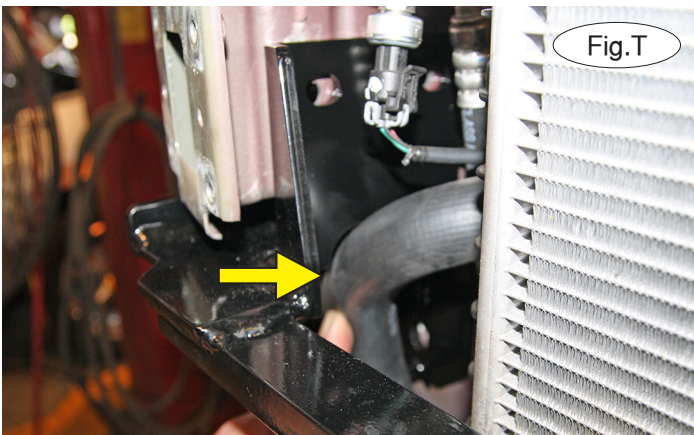

17. On each side, center the openings on the face plate over the holes as much as possible (Fig.U). Then, place two 1/2" flat washers over two 1/2" x 4" bolts and pass them through the upper holes enlarged in step 13 (Fig.V). Finish the bolts with two 1/2" flat washers, 1/2" lock washers and 1/2" nuts (Fig.W). *Note:* On the passenger side, if the air conditioning line is contacting on the rear bolt, gently push it toward the center of the vehicle to allow clearance.

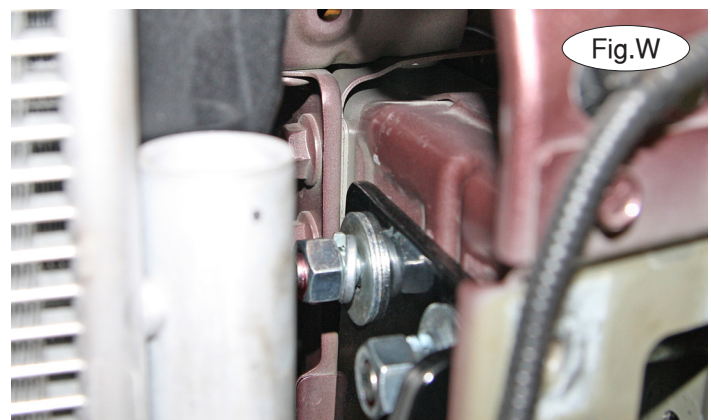
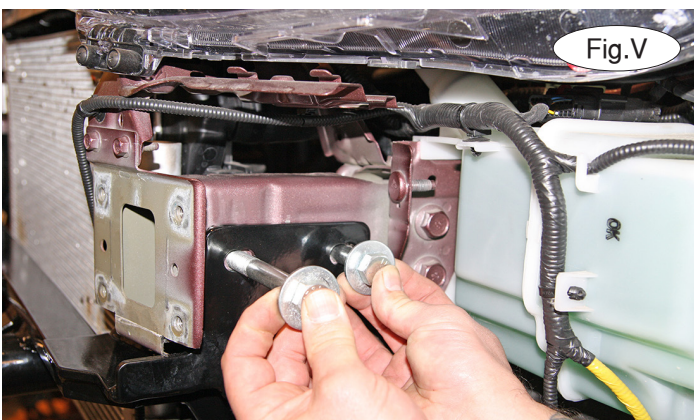



BASEPLATE KIT INSTALLATION INSTRUCTIONS

KIT# 523202-5

02/21/22
KS

ROADMASTER, Inc. 6110 NE 127th Ave. Vancouver, WA 98682 360-896-0407 fax 360-735-9300 www.roadmasterinc.com

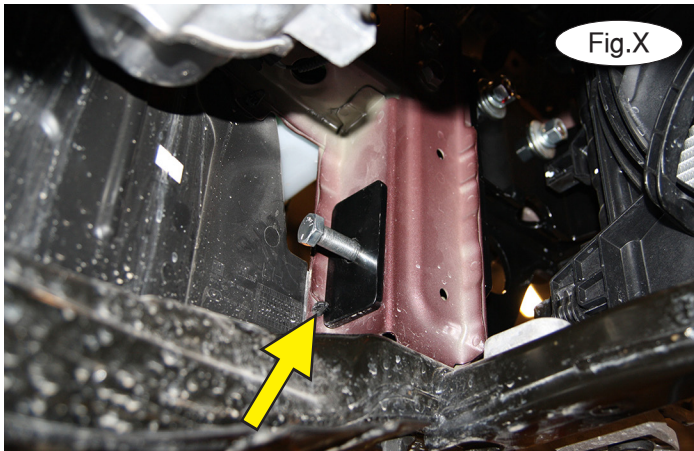

18. On each side, place a $\frac{1}{4}$ " x 2" x $3\frac{1}{2}$ " plate over the rearmost hole you drilled in step 13. Pass a $\frac{1}{2}$ " x $4\frac{1}{2}$ " bolt through the plate, both sides of the frame, and through the baseplate (Fig.X). *Note:* Ensure that the plate sits behind the plastic fastener attaching the fender liner to the frame. Finish with a small $\frac{1}{2}$ " flat washer, $\frac{1}{2}$ " lock washer and $\frac{1}{2}$ " nut. Tighten these bolts to the bolt torque requirements found at the end of these instructions, and then tighten the upper bolts.

19. Carefully trim the fascia (Fig.Y). Ensure that you do not cut into the sensor. Then, reinstall the fascia, reversing steps 1 through 11.

20. On each side, insert the removable front arm into the front receiver 90 degrees from its final towing position, depressing the spring-loaded pin against the receiver. Twist back 90 degrees until the spring-loaded pin snaps into place in the notch on the receiver, locking the arm into place in its final towing position.

Please note: it is the owner's responsibility to ensure the locking of the pins before towing. Otherwise, failure of the towing system will result.

21. Install the tow bar to the mounting bracket according to the manufacturer's instructions.

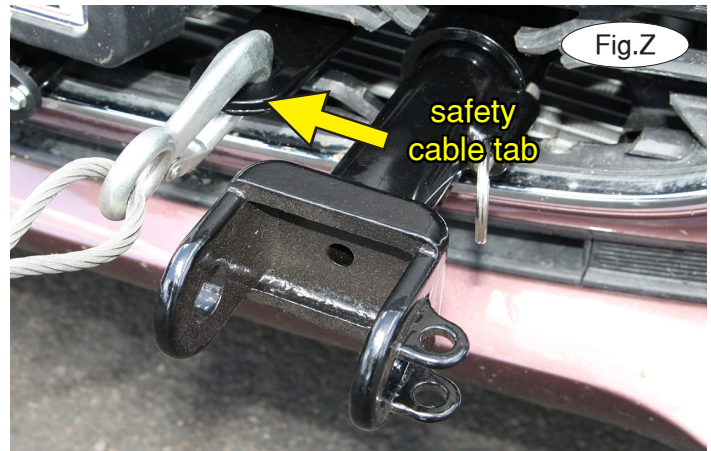

IMPORTANT!

Safety cables are required by law. When towing, connect safety cables to the safety cable tabs illustrated in Figure Z. Make certain there is adequate slack in the cables to allow a full turning radius; otherwise, damage will result. If necessary, longer cables or cable extensions are available.



BASEPLATE KIT INSTALLATION INSTRUCTIONS

KIT# 523202-5

02/21/22
KS

ROADMASTER, Inc. 6110 NE 127th Ave. Vancouver, WA 98682 360-896-0407 fax 360-735-9300 www.roadmasterinc.com

Three options for attaching the wiring plug to the main receiver brace

For six-wire plugs: use the two supplied 3/4" self-tapping screws to attach the electrical plug directly to the rods on the front of the main receiver brace.

For four-wire round plugs: attach to the plug mounting plate and then use the two supplied 3/4" self-tapping screws to attach the mounting plate to the rods on the front of the main receiver brace.

For four-wire flat plugs: place the plug through the mounting plug plate, and then secure it using the supplied zip tie on the front of the plug (Fig.AA). Use the two supplied 3/4" self-tapping screws to attach the mounting plate to the rods on the front of the main receiver brace.

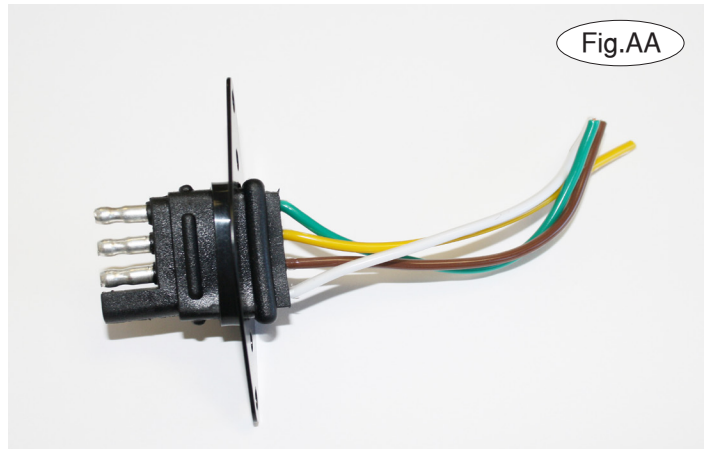

Fig.AA

BOLT TORQUE REQUIREMENTS

Note: The torque values represented below are intended as general guidelines. Torque requirements for specific applications may vary. Roadmaster does not warrant this information to be accurate for all applications and disclaims all liability for any claims or damages which may result from its use.

STANDARD BOLTS

Thread Size	Grade	Torque
5/16-18	5	13 ft./lb.
3/8-16	5	23 ft./lb.
7/16-14	5	37 ft./lb.
1/2-13	5	57 ft./lb.
5/8-11	5	112 ft./lb.

METRIC BOLTS

Thread Size	Grade	Torque
6mm-1.0	8.8	6 ft./lb.
8mm-1.0	8.8	18 ft./lb.
8mm-1.25	8.8	16 ft./lb.
10mm-1.25	8.8	36 ft./lb.
10mm-1.5	8.8	31 ft./lb.

METRIC BOLTS

Thread Size	Grade	Torque
12mm-1.25	8.8	64 ft./lb.
12mm-1.5	8.8	60 ft./lb.
12mm-1.75	8.8	55 ft./lb.
14mm-2.0	8.8	88 ft./lb.

All illustrations and specifications contained herein are based on the latest information available at the time of publication approval. ROADMASTER, INC. reserves the right to make changes at any time without notice in material, specification and models or to discontinue models.