



# BASEPLATE KIT INSTALLATION INSTRUCTIONS

**KIT# 523203-5**

12/16/20  
KS

ROADMASTER, Inc. 6110 NE 127th Ave. Vancouver, WA 98682 360-896-0407 fax 360-735-9300 www.roadmasterinc.com

*Important*  
*Note: This baseplate will not accommodate the Guardian rock shield, some models of the Tow Defender, or any StowMaster tow bar.*

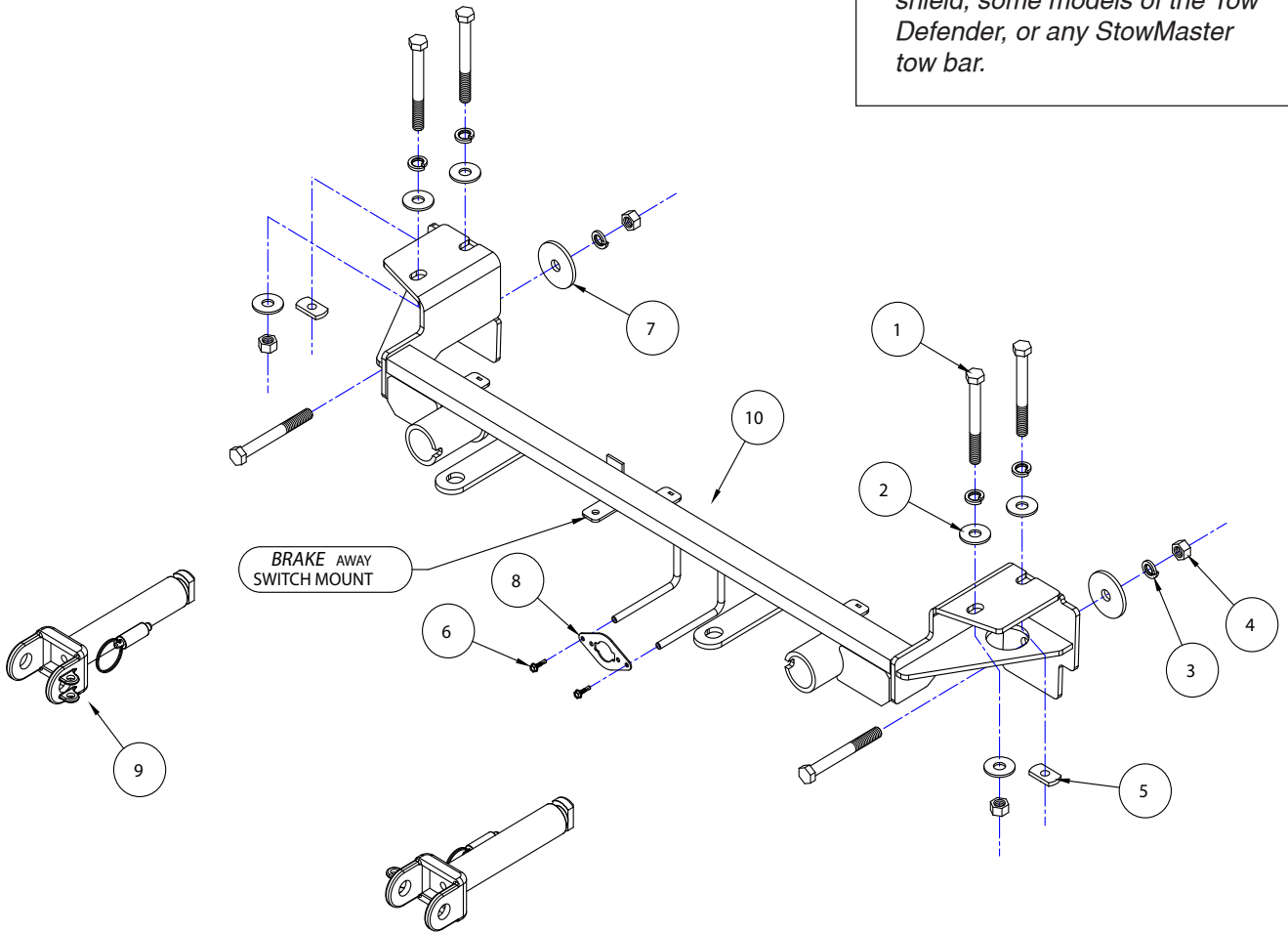

ITEM	QTY	NAME	MATERIAL
1.....6.....	6	1/2" x 4 1/2" BOLT .....	350106-00
2.....6.....	6	1/2" FLAT WASHER .....	350308-00
3.....6.....	6	1/2" LOCK WASHER .....	350309-00
4.....4.....	4	1/2" NUT .....	350258-00
5.....2.....	2	1/2" TAB WELD NUT .....	350270-00
6.....2.....	2	#10 x 3/4" SELF DRILLING SCREW .....	350247-00
7.....2.....	2	1/2" PLATE WASHER.....	A-003086
8.....1.....	1	WIRE PLUG PLATE .....	A-003801
9.....2.....	2	ARM.....	C-002383
10.....1.....	1	MAIN RECEIVER .....	C-003472



# BASEPLATE KIT INSTALLATION INSTRUCTIONS

**KIT# 523203-5**

12/16/20  
KS

ROADMASTER, Inc. 6110 NE 127th Ave. Vancouver, WA 98682 360-896-0407 fax 360-735-9300 www.roadmasterinc.com

This is one of our direct-connect baseplates, which allows the visible front portion of the bracket to be easily removed from the front of the vehicle (Fig.A and Fig.B).

The baseplate mounts to the frame of the vehicle and consists of two main receiver braces, two removable front braces, and a hardware pack.

Before starting the installation, lay out the kit components in order, as they will be used. This will give you a visual idea of how the components work, and will also confirm that everything is present and accounted for.



**IMPORTANT:** All baseplates *must* be assembled with all the bolts left loose for final adjustment and positioning (before tightening) unless otherwise instructed. All bolts *must* be torqued for proper strength. If more than one bolt is used per fastening point, the diagram may only show one. Use flat washers over all slotted holes and lock washers on all fasteners.

## WARNING

Failure to heed these warnings or follow the installation instructions may result in a voided warranty, loss of towed vehicle, personal injury or death.

- Do not weld or modify this baseplate or its components. Welding or modification will void the warranty.
- Do not use this document as a basis to design/fabricate a baseplate, as it may not show all parts or structural components.
- We strongly recommend professional installation.
- If the towed vehicle has been in an accident, it must be properly repaired before attaching the baseplate. Do not install the baseplate if any structural frame damage is found.
- The installer must use all bolts and parts supplied. If running changes were made by the vehicle manufacturer after this kit was designed, some bolts or other fasteners may no longer be the correct size. It is the installer's responsibility to verify this kit is securely fastened to the vehicle.
- Use Loctite® Red on all bolts used to secure this baseplate. Torque all bolts to the specifications found at the end of these instructions. Do not over-torque the bolts or failure may occur.
- The installer must inspect the baseplate to ensure adequate clearance, particularly around hoses, air conditioner lines, radiators, etc. or non-warranty failure may result.
- Roadmaster manufactures many styles of baseplates. If your baseplate has removable arms, they must be removed before driving the vehicle, unless the arms can be pinned or padlocked in place. If not secured, the arms could vibrate out.
- Some motorhome chassis have such a tight turning radius that you can damage your motorhome, towed vehicle, tow bar or baseplate while turning sharply. Before getting on the road, test your turning radius in an empty parking lot. Turning too sharply could result in non-warranty damage to your towing system, motorhome and/or towed vehicle.
- Do not back up with the towed vehicle attached or non-warranty damage will occur to your towing system or vehicles.
- The safety cables must connect the towing vehicle to the towed vehicle frame to frame, with the cables crossed, with enough slack for sharp turns. See cable instructions for proper routing. Failure to do so will result in non-warranty damage and/or the loss of the towed vehicle.
- This kit is designed for use with ROADMASTER tow bars and ROADMASTER adapters only. Using this kit with other brands, without an approved ROADMASTER adapter, may result in non-warranty damage or injury.
- Receiver extensions and out-of-level towing situations of 3 inches or more. This can cause the system to swing much higher and lower, causing excessive strain on the tow bar, baseplate and frame. That can cause the towing system to fail, causing property damage, personal injury or even death. If you must use a receiver extension or drop hitch to tow, it will reduce your receiver's weight capacity by 1/3 to avoid damaging your system. Never use more than one extension and/or drop hitch, as this will void your warranty.
- Every 3,000 miles, the owner must inspect all mounting points for cracks or fatigue, and check the fasteners for proper torque, according to the bolt torque requirements chart on the last page of these instructions.
- The owner must follow the vehicle manufacturer's instructions to prepare the vehicle for towing. Failure to do so may cause severe damage to the vehicle.
- This baseplate is only warranted for the original installation. Installing a used baseplate on another vehicle is not recommended and will void the warranty.



# BASEPLATE KIT INSTALLATION INSTRUCTIONS

**KIT# 523203-5**

12/16/20  
KS

ROADMASTER, Inc. 6110 NE 127th Ave. Vancouver, WA 98682 360-896-0407 fax 360-735-9300 www.roadmasterinc.com



1. **Important:** please use all supplied bolts and parts and read all instructions carefully before beginning this installation. The majority of questions you may have can be answered within the text, and proper installation will ensure safe and secure travel. On each side, remove three 10mm (head) bolts and three plastic fasteners attaching the top of the fascia to the radiator support (Fig.C).

2. On each side, turn the tire inward and remove the four T20 Torx (head) screws attaching the fender liner to the fascia and the corner of the fascia to the fender (Fig.D). *Note:* Due to manufacturing variances, some or all of these screws, as well as those in the following steps, may be a T15.

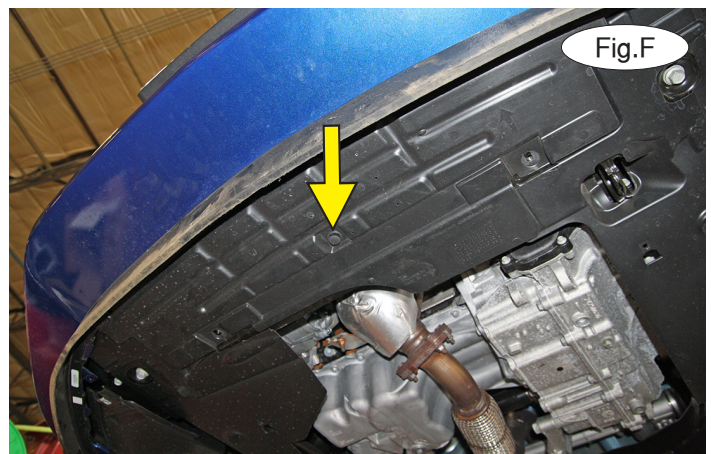
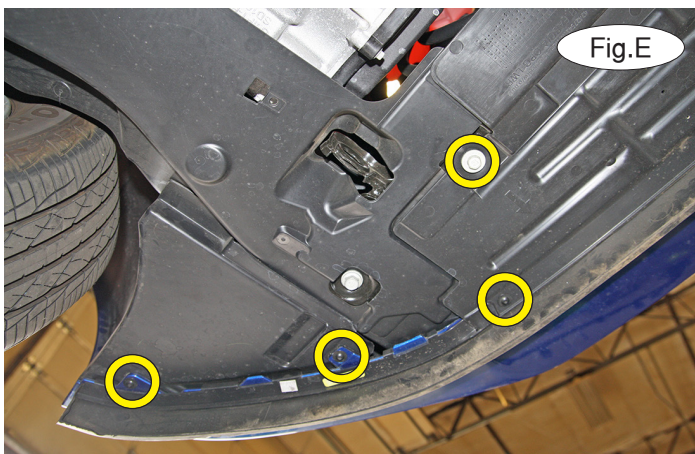

3. On each side, remove three T20 screws and one 13mm (head) bolt attaching the splash shield to the fascia and subframe (Fig.E).

4. Remove one plastic fastener attaching the splash shield to the subframe (Fig.F). Pull toward the rear of the vehicle to remove it, and set it aside for now.

5. On each side, remove one 7mm (head) screw attaching the fascia to the subframe (Fig.G).

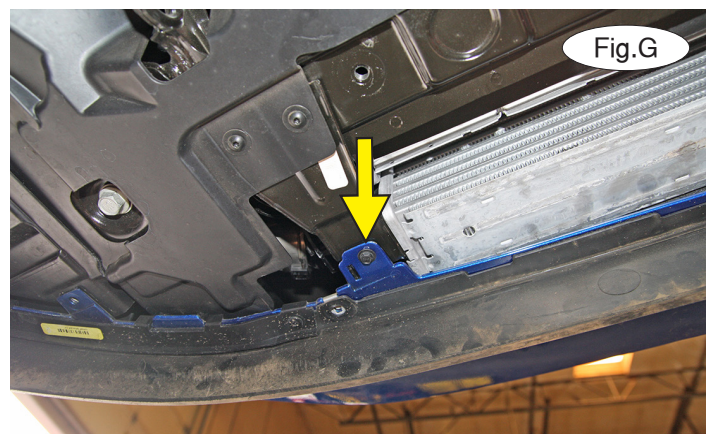



# BASEPLATE KIT INSTALLATION INSTRUCTIONS

**KIT# 523203-5**

12/16/20  
KS

ROADMASTER, Inc. 6110 NE 127th Ave. Vancouver, WA 98682 360-896-0407 fax 360-735-9300 www.roadmasterinc.com

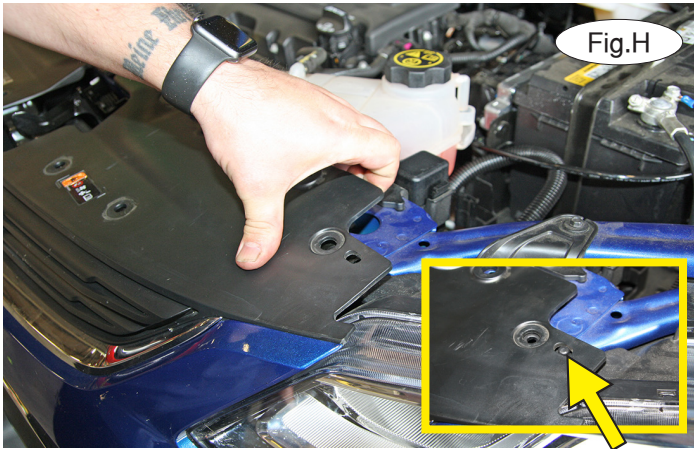

6. On each side, lift up to release the top clip (Fig.H and Fig.H – inset) and then pull out on the corner of the fascia to release the locking strips under the headlight (Fig.I). Disconnect the ambient temperature sensor and fog lights, if the vehicle is so equipped. Set the fascia aside for now.

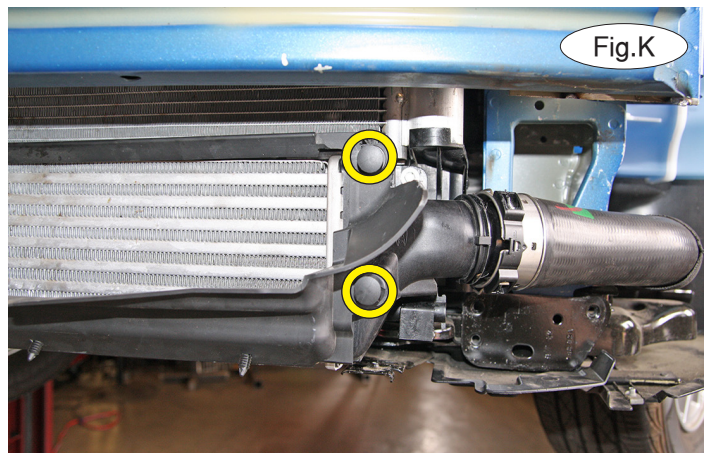
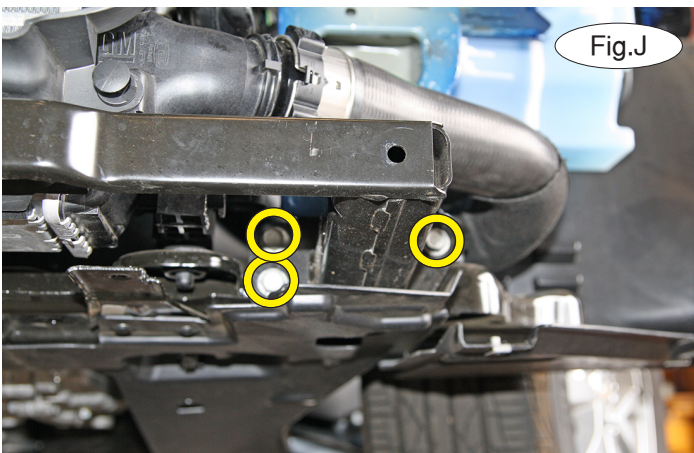

7. On each side, remove three 13mm (head) bolts attaching the lower frame support to the subframe (Fig.J). Set it aside for now.

8. On each side, remove two plastic fasteners attaching the air dam to the intercooler (Fig.K). It will not be replaced. *Note:* Retain the air dam and its fasteners for replacement in case the baseplate is ever removed.

9. On each side, disconnect the air hose from the inlet, attaching it to the intercooler, using a flathead screwdriver to pry out the metal retaining clip, pulling away from the intercooler to release it (Fig.L and Fig.L – inset).

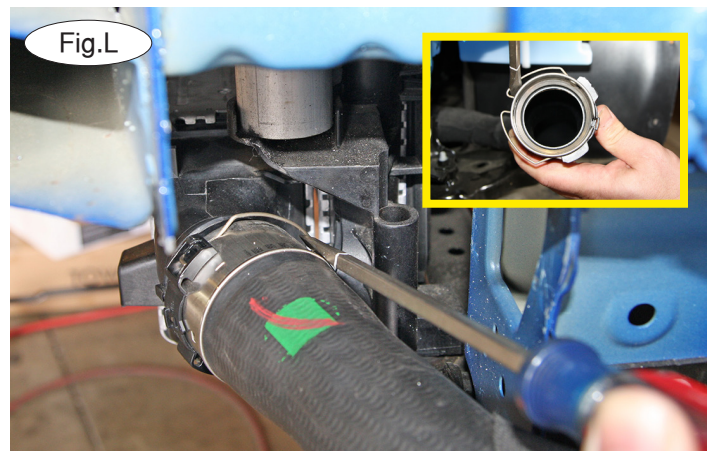



# BASEPLATE KIT INSTALLATION INSTRUCTIONS

**KIT# 523203-5**

12/16/20  
KS

ROADMASTER, Inc. 6110 NE 127th Ave. Vancouver, WA 98682 360-896-0407 fax 360-735-9300 www.roadmasterinc.com

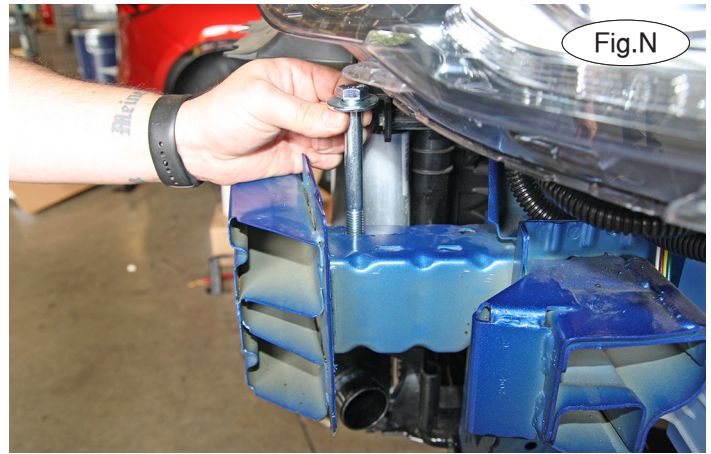
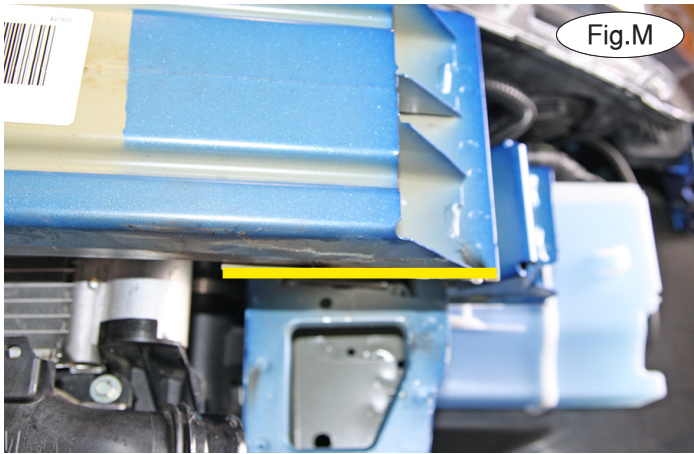

10. On each side, use a die grinder or reciprocating saw to trim the bottom portion of the bumper core flange so it is flush with the bumper core (Fig.M).

11. On each side, place a 1/2" flat washer over a 1/2" x 4 1/2" bolt and pass the bolt down through the top of the bumper core mount (Fig.N).

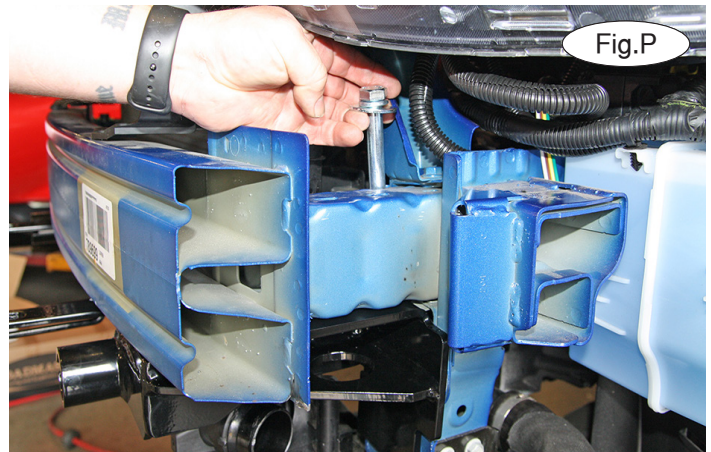
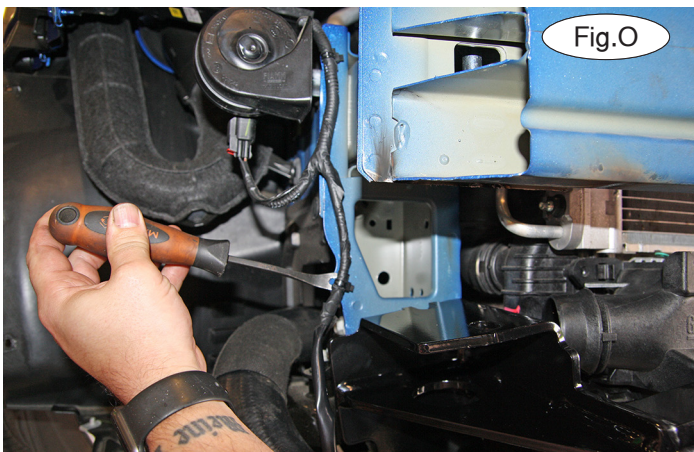

12. With the help of another person, maneuver the bottom ends of the baseplate over and behind the ends of the intercooler. Then, slide it up into place over the bolts you just inserted in the previous step. Finish the bolt with a 1/2" flat washer, 1/2" lock washer and 1/2" nut and finger tighten it. *Note:* If there are any wiring harnesses in the way, unclip them (Fig.O).

13. Now, place a 1/2" lock washer and 1/2" flat washer over a 1/2" x 4 1/2" bolt and pass the bolt down through the rear hole of the bumper core mount and baseplate (Fig.P). Finish with a 1/2" tabbed weld nut (Fig.Q).

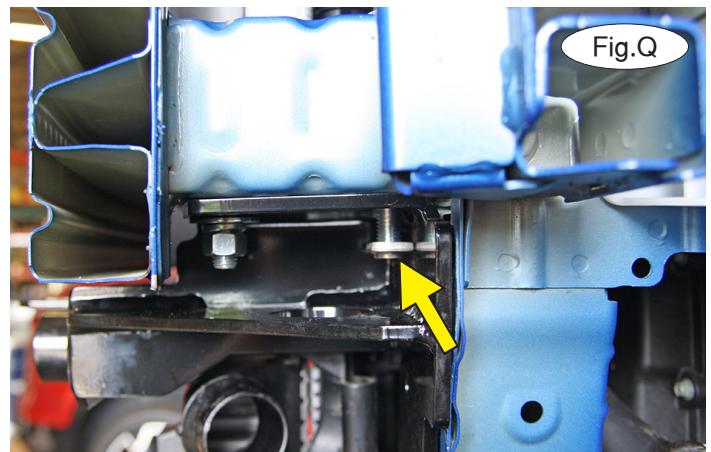



# BASEPLATE KIT INSTALLATION INSTRUCTIONS

**KIT# 523203-5**

12/16/20  
KS

ROADMASTER, Inc. 6110 NE 127th Ave. Vancouver, WA 98682 360-896-0407 fax 360-735-9300 www.roadmasterinc.com

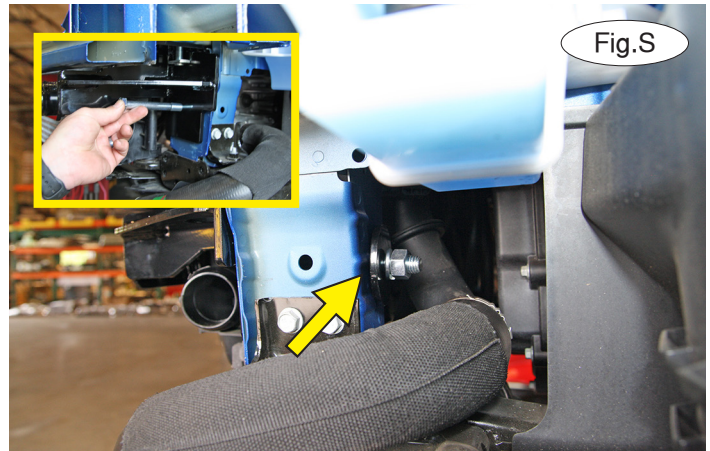
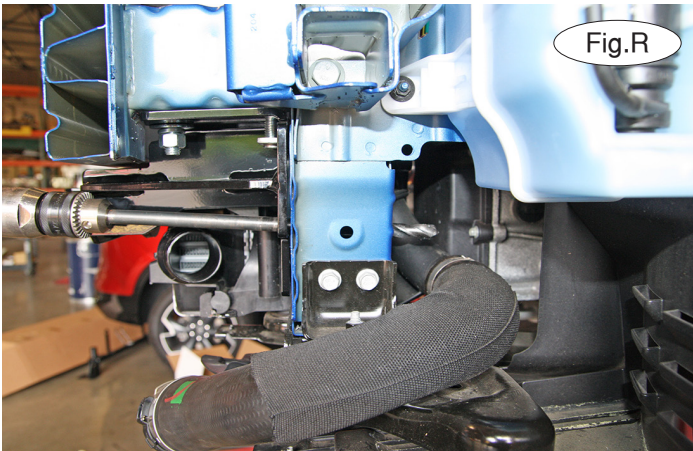

14. On each side, use a ½" drill bit to drill through the lower mount and back wall of the frame extension (Fig.R). Place a ½" x 4½" bolt through the hole and the frame extension. Finish with a ½" plate washer, ½" lock washer and ½" nut (Fig.S and Fig.S – inset).

15. Beginning with the uppermost bolts, tighten them using the bolt torque requirements found at the end of these instructions. Now, torque the bottom bolts.



16. On each side, reattach the air hoses and the lower frame support by reversing steps 7 and 9.

17. On the back of the fascia, on the passenger side only, remove the ambient temperature sensor from its mount and unclip the first wiring harness clip (Fig.T). Zip tie it out of the way.

18. Trim the fascia as shown in Figure U and then reinstall the fascia, reversing steps 1 through 6.

19. On each side, insert the removable front arm into the front receiver 90 degrees from its final towing position, depressing the spring-loaded pin against the receiver. Twist back 90 degrees until the spring-loaded pin snaps into place in the notch on the receiver, locking the arm into place in its final towing position.

**Please note: it is the owner's responsibility to ensure the locking of the pins before towing. Otherwise, failure of the towing system will result.**



# BASEPLATE KIT INSTALLATION INSTRUCTIONS

**KIT# 523203-5**

12/16/20  
KS

ROADMASTER, Inc. 6110 NE 127th Ave. Vancouver, WA 98682 360-896-0407 fax 360-735-9300 www.roadmasterinc.com

20. Install the tow bar to the mounting bracket according to the manufacturer's instructions.

**IMPORTANT!**

**Safety cables are required by law. When towing, connect safety cables to the safety cable tabs illustrated in Figure V. Make certain there is adequate slack in the cables to allow a full turning radius; otherwise, damage will result. If necessary, longer cables or cable extensions are available.**

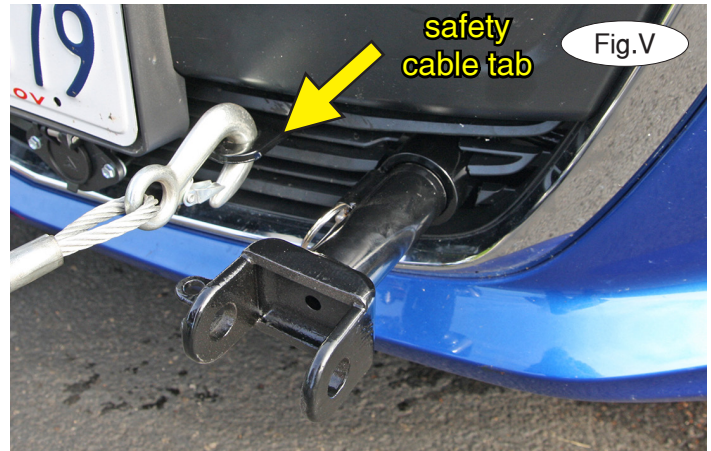

Fig.V

### Three options for attaching the wiring plug to the main receiver brace

**For six-wire plugs:** use the two supplied 3/4" self-tapping screws to attach the electrical plug directly to the rods on the front of the main receiver brace.

**For four-wire round plugs:** attach to the plug mounting plate and then use the two supplied 3/4" self-tapping screws to attach the mounting plate to the rods on the front of the main receiver brace.

**For four-wire flat plugs:** place the plug through the mounting plug plate, and then secure it using the supplied zip tie on the front of the plug (Fig.W). Use the two supplied 3/4" self-tapping screws to attach the mounting plate to the rods on the front of the main receiver brace.

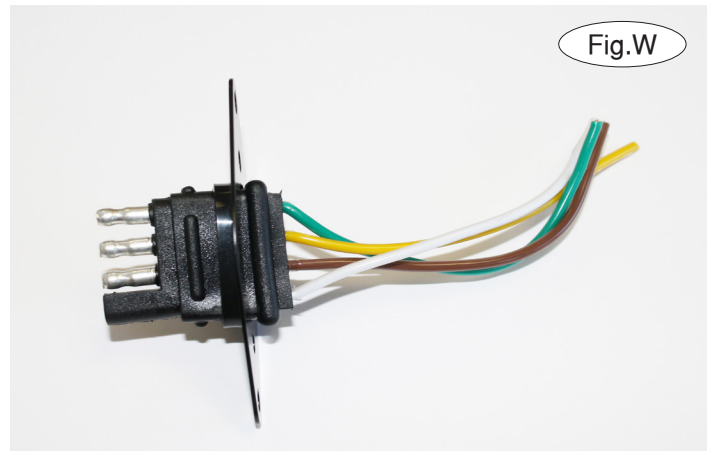

Fig.W

### BOLT TORQUE REQUIREMENTS

Note: The torque values represented below are intended as general guidelines. Torque requirements for specific applications may vary. Roadmaster does not warrant this information to be accurate for all applications and disclaims all liability for any claims or damages which may result from its use.

#### STANDARD BOLTS

Thread Size	Grade	Torque
5/16-18	5	13 ft./lb.
3/8-16	5	23 ft./lb.
7/16-14	5	37 ft./lb.
1/2-13	5	57 ft./lb.
5/8-11	5	112 ft./lb.

#### METRIC BOLTS

Thread Size	Grade	Torque
6mm-1.0	8.8	6 ft./lb.
8mm-1.0	8.8	18 ft./lb.
8mm-1.25	8.8	16 ft./lb.
10mm-1.25	8.8	36 ft./lb.
10mm-1.5	8.8	31 ft./lb.

#### METRIC BOLTS

Thread Size	Grade	Torque
12mm-1.25	8.8	64 ft./lb.
12mm-1.5	8.8	60 ft./lb.
12mm-1.75	8.8	55 ft./lb.
14mm-2.0	8.8	88 ft./lb.

All illustrations and specifications contained herein are based on the latest information available at the time of publication approval. ROADMASTER, INC. reserves the right to make changes at any time without notice in material, specification and models or to discontinue models.