



BASEPLATE KIT INSTALLATION INSTRUCTIONS

KIT# 523209-5

09/24
RS

ROADMASTER, Inc.

6110 NE 127th Ave.

Vancouver, WA 98682

360-896-0407

www.RoadmasterInc.com

Second person
Ratchet
7mm, 13mm, 15mm, 17mm sockets
3/4" wrench
3/4" socket

What You'll Need

Flathead screwdriver
Panel tool
17/32" drill bit and drill

T15 Torx screwdriver or bit
Needlenose pliers
Torque wrench
Loctite® Red
Utility knife

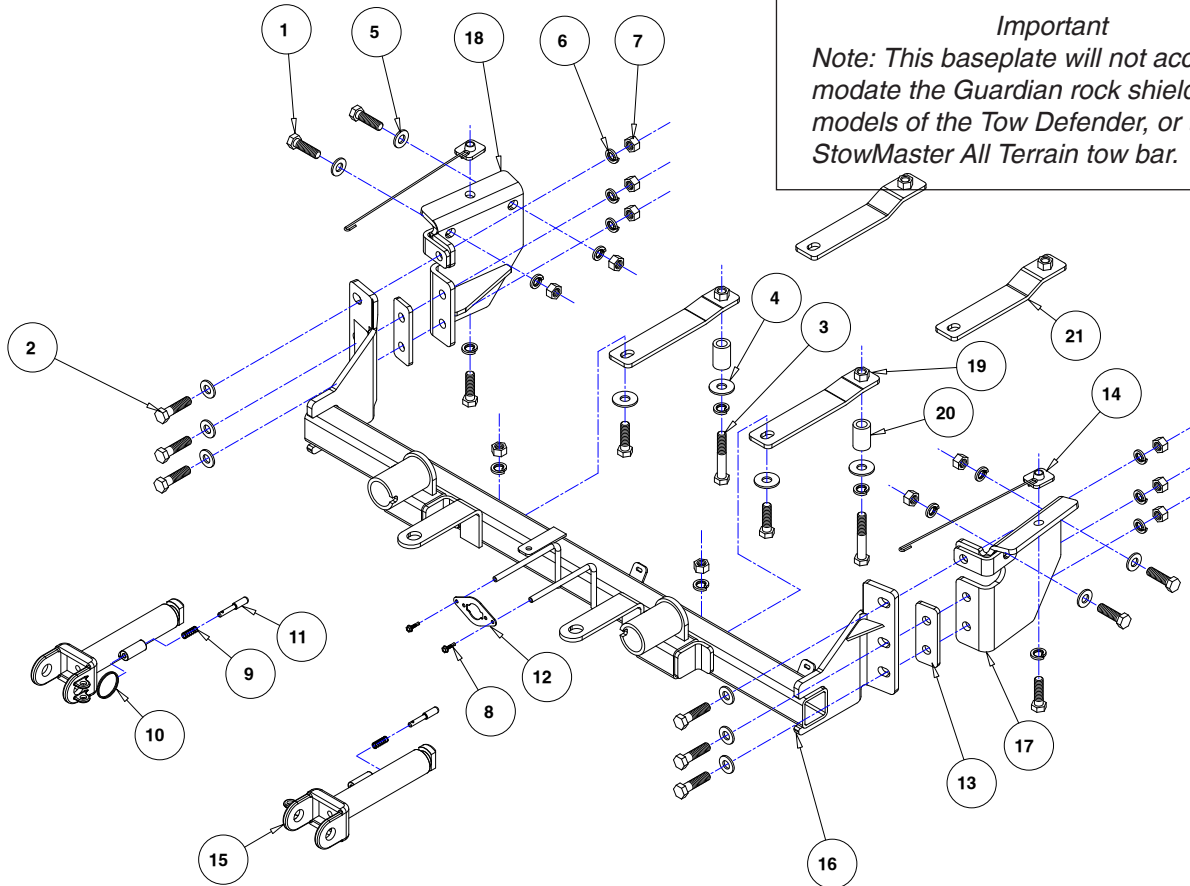

Important
Note: This baseplate will not accommodate the Guardian rock shield, some models of the Tow Defender, or the StowMaster All Terrain tow bar.

ITEM #	QTY	NAME	PART #
1	8	1/2" x 1 3/4" BOLT	350096-00
2	6	1/2" x 2" BOLT	350097-00
3	2	1/2" x 3" BOLT	350101-00
4	4	1/2" FLAT WASHER	350308-00
5	10	1/2" FLAT WASHER SAE	350308-20
6	16	1/2" LOCK WASHER	350309-00
7	12	1/2" NUT	350258-00
8	2	#10-16 x 3/4" SELF DRILLING SCREW	350247-35
9	2	SPRING	200146-00
10	2	RING	350520-00
11	2	LOCK PIN	A000008
12	1	WIRE PLUG PLATE	A003801
13	2	SPACER PLATE	A006230
14	2	1 1/4" x 1 1/2" BACKING PLATE WITH 10" ROD	C002501
15	2	ARM	C002383
16	1	MAIN RECEIVER	C003567
17	1	DRIVER SIDE REAR BRACE	C003468
18	1	PASSENGER SIDE REAR BRACE	C003469
19	2	REAR BRACE	C003568
20	2	1" O.D. x 1 1/2" SPACER	A000872
21	2	REAR BRACE	C003841



BASEPLATE KIT INSTALLATION INSTRUCTIONS

KIT# 523209-5

09/24
RS

ROADMASTER, Inc.

6110 NE 127th Ave.

Vancouver, WA 98682

360-896-0407

www.RoadmasterInc.com

This is one of our direct-connect baseplates, which allows the visible front portion of the bracket to be easily removed from the front of the vehicle (Fig.A and Fig.B).

The baseplate mounts to the frame of the vehicle and consists of two main receiver braces, two removable front braces, and a hardware pack.

Before starting the installation, lay out the kit components in order, as they will be used. This will give you a visual idea of how the components work, and will also confirm that everything is present and accounted for.



Fig.A



Fig.B

IMPORTANT: All baseplates **must** be assembled with all the bolts left loose for final adjustment and positioning (before tightening) unless otherwise instructed. All bolts **must** be torqued for proper strength. If more than one bolt is used per fastening point, the diagram may only show one. Use flat washers over all slotted holes and lock washers on all fasteners.

WARNING

Failure to heed these warnings or follow the installation instructions may result in a voided warranty, loss of towed vehicle, personal injury or death.

- Do not weld or modify this baseplate or its components. Welding or modification will void the warranty.
- Do not use this document as a basis to design/fabricate a baseplate, as it may not show all parts or structural components.
- We strongly recommend professional installation.
- If the towed vehicle has been in an accident, it must be properly repaired before attaching the baseplate. Do not install the baseplate if any structural frame damage is found.
- The installer must use all bolts and parts supplied. If running changes were made by the vehicle manufacturer after this kit was designed, some bolts or other fasteners may no longer be the correct size. It is the installer's responsibility to verify this kit is securely fastened to the vehicle.
- Use Loctite® Red on all bolts used to secure this baseplate. Torque all bolts to the specifications found at the end of these instructions. Do not over-torque the bolts or failure may occur.
- The installer must inspect the baseplate to ensure adequate clearance, particularly around hoses, air conditioner lines, radiators, etc. or non-warranty failure may result.
- Roadmaster manufactures many styles of baseplates. If your baseplate has removable arms, they must be removed before driving the vehicle, unless the arms can be pinned or padlocked in place. If not secured, the arms could vibrate out.
- Some motorhome chassis have such a tight turning radius that you can damage your motorhome, towed vehicle, tow bar or baseplate while turning sharply. Before getting on the road, test your turning radius in an empty parking lot. Turning too sharply could

result in non-warranty damage to your towing system, motorhome and/or towed vehicle.

- Do not back up with the towed vehicle attached or non-warranty damage will occur to your towing system or vehicles.
- The safety cables must connect the towing vehicle to the towed vehicle frame to frame, with the cables crossed, with enough slack for sharp turns. See cable instructions for proper routing. Failure to do so will result in non-warranty damage and/or the loss of the towed vehicle.
- This kit is designed for use with ROADMASTER tow bars and ROADMASTER adapters only. Using this kit with other brands, without an approved ROADMASTER adapter, may result in non-warranty damage or injury.
- Receiver extensions and out-of-level towing situations of 3 inches or more. This can cause the system to swing much higher and lower, causing excessive strain on the tow bar, baseplate and frame. That can cause the towing system to fail, causing property damage, personal injury or even death. If you must use a receiver extension or drop hitch to tow, it will reduce your receiver's weight capacity by 1/3 to avoid damaging your system. Never use more than one extension and/or drop hitch, as this will void your warranty.
- Every 3,000 miles, the owner must inspect all mounting points for cracks or fatigue, and check the fasteners for proper torque, according to the bolt torque requirements chart on the last page of these instructions.
- The owner must follow the vehicle manufacturer's instructions to prepare the vehicle for towing. Failure to do so may cause severe damage to the vehicle.
- This baseplate is only warranted for the original installation. Installing a used baseplate on another vehicle is not recommended and will void the warranty.



BASEPLATE KIT INSTALLATION INSTRUCTIONS

KIT# 523209-5

09/24
RS

ROADMASTER, Inc.

6110 NE 127th Ave.

Vancouver, WA 98682

360-896-0407

www.RoadmasterInc.com

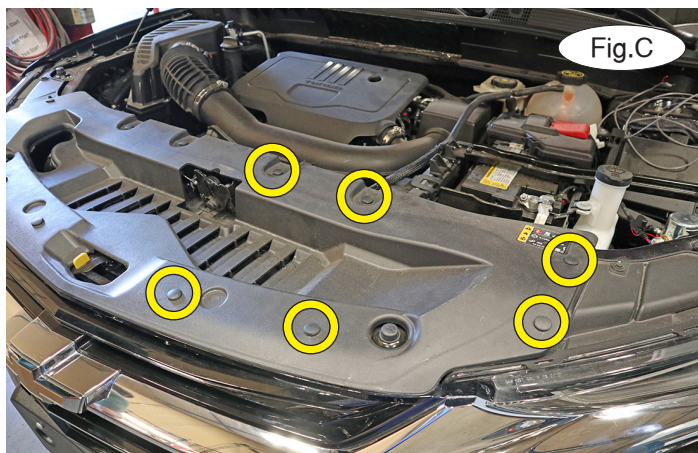

Important: Please use all supplied hardware and read through these instructions carefully before beginning this installation. The majority of questions you may have can be answered within the text, and proper installation will ensure safe and secure travel.

1. On each side, remove six plastic fasteners attaching the radiator cover to the fascia and core support (Fig.C). Pull up to remove it and set it aside for now.
2. On each side, remove three T15 screws attaching the top of the fascia to the core support (Fig.D).

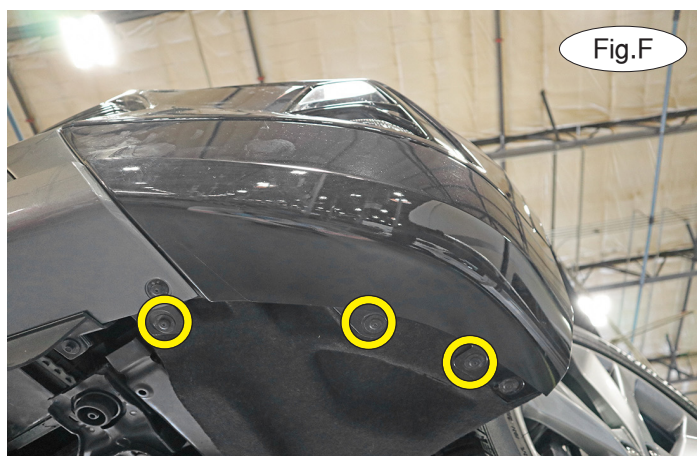
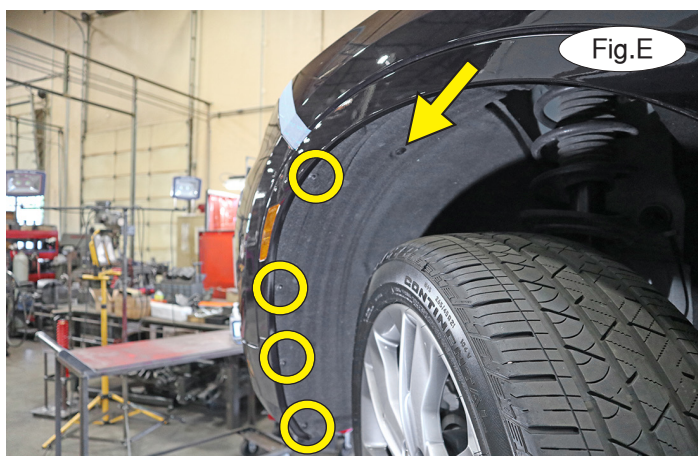

3. Starting on the driver's side, turn the wheel inward and then remove four T15 screws (Fig.E – circles) and one plastic fastener (Fig.E – arrow) attaching the fender liner to the fascia.

4. On each side, remove three T15 screws attaching the bottom of the fender liner to the bottom of the fascia (Fig.F).

5. Repeat steps 3 and 4 for the passenger side.

6. Remove two 7mm screws attaching the bottom of the fascia to the air dam (Fig.G).





BASEPLATE KIT INSTALLATION INSTRUCTIONS

KIT# 523209-5

09/24
RS

ROADMASTER, Inc.

6110 NE 127th Ave.

Vancouver, WA 98682

360-896-0407

www.RoadmasterInc.com

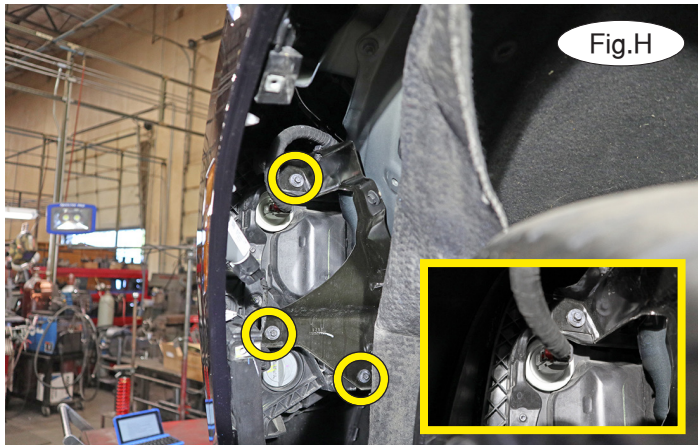

7. On each side, remove three 7mm screws attaching the headlight bucket to the frame (Fig.H) and unplug its harness (Fig.H – inset). Then, unplug the side marker lights (Fig.I).

8. On each side, use a pair of needlenose pliers to squeeze the arrowhead clips to release the fender trim past the center toward the rear of the car (Fig.J). *Note:* It may be helpful to use a soft rag to hold the fender trim away from the vehicle. Then, remove one T15 screw attaching the top corner of the fascia to the fender (Fig.K).

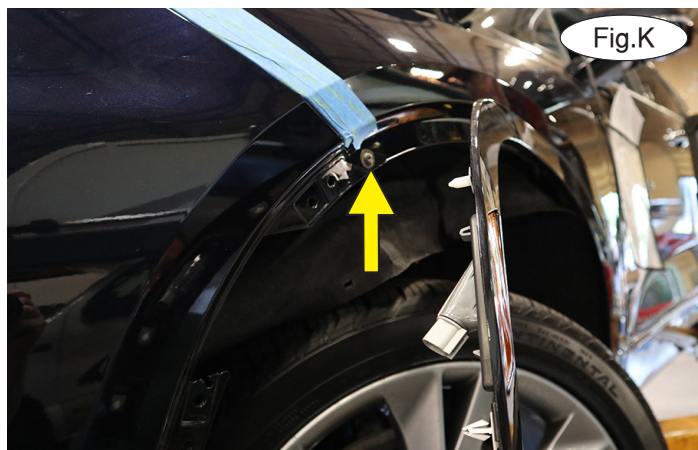

9. With the assistance of a second person, pull out on the seam of the fascia on each side (Fig.L – driver's side) and disconnect any wiring harnesses. Set the fascia aside for now.

10. Remove five 7mm screws attaching the air dam to the bumper core and subframe (Fig.M). *Note:* The fifth screw is behind the ACC mount, if the vehicle is so equipped. Its approximate location is denoted with an arrow (Fig.M). Set the air dam aside to be trimmed and reinstalled later.

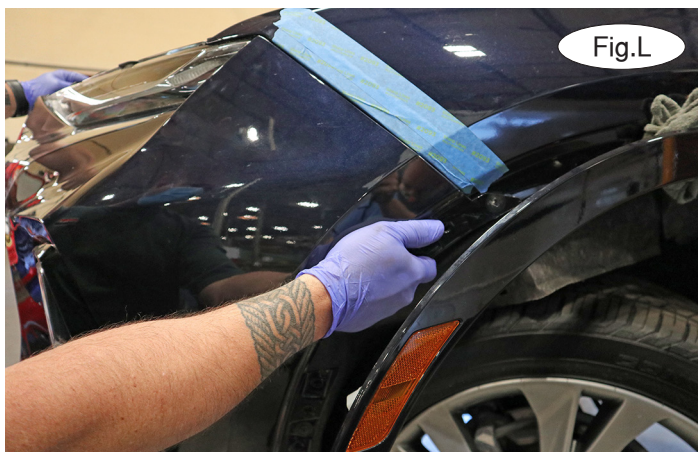



BASEPLATE KIT INSTALLATION INSTRUCTIONS

KIT# 523209-5

09/24
RS

ROADMASTER, Inc.

6110 NE 127th Ave.

Vancouver, WA 98682

360-896-0407

www.RoadmasterInc.com

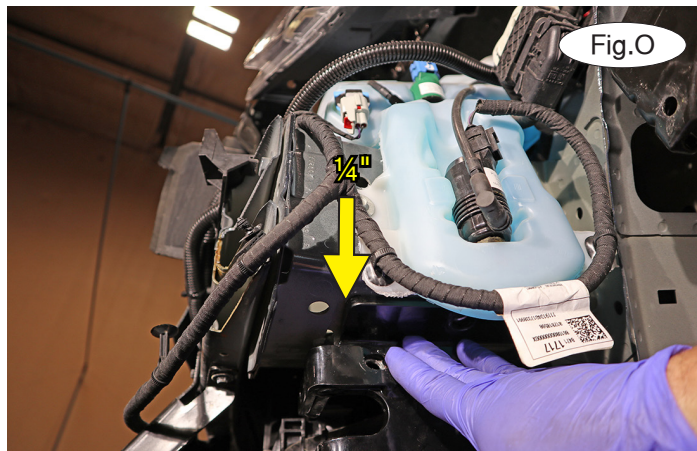
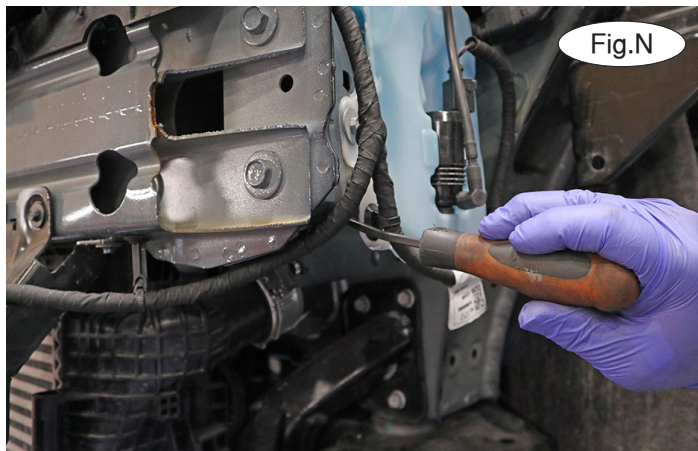

11. Working on the driver's side only, unclip the ACC harness as shown in Figure N. Then, using the drawing on page 1 as a reference, locate the side-specific brace and temporarily hold it in place under the bumper core, against the pinch weld, and approximately $\frac{1}{4}$ " from the bumper core flange seam (Fig.O). Mark the frame in three spots for drilling (Fig.P) and remove the brace. Then, hold the wiring harness out of the way and drill two $\frac{17}{32}$ " holes in the bottom of the pinch weld (Fig.Q) and one hole in the bottom of the frame (Fig.R).



12. Insert one of the $\frac{3}{16}$ " x $1\frac{1}{2}$ " x $\frac{1}{4}$ " nutted backing plates with rod through the access hole in the bumper core (Fig.S). Place a $\frac{1}{2}$ " lock washer and Loctite on a $\frac{1}{2}$ " x $1\frac{1}{2}$ " bolt. Hold the side-specific brace in place over the holes drilled in the previous step and then pass the bolt through the upper mount of the baseplate, the frame, and into the backing plate (Fig.T – next page). Finger tighten the bolt. Ensure that the side-specific brace is snug against the pinch weld before proceeding.

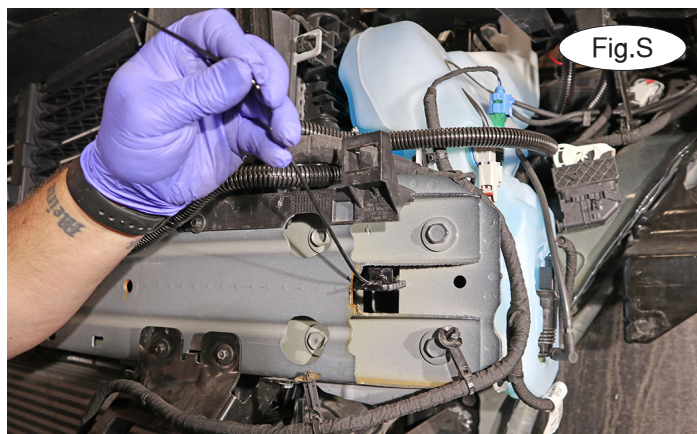
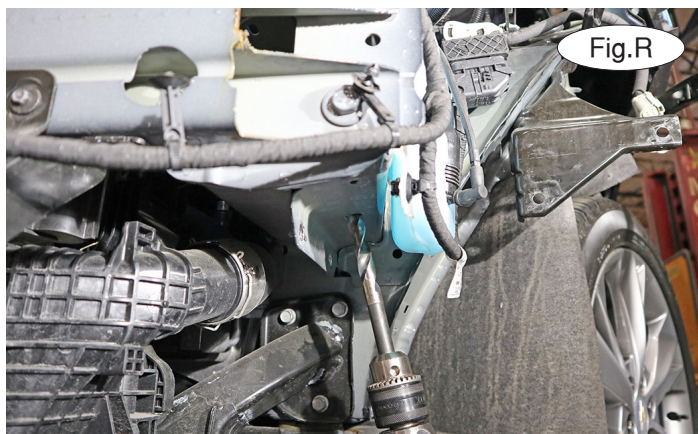



BASEPLATE KIT INSTALLATION INSTRUCTIONS

KIT# 523209-5

09/24
RS

ROADMASTER, Inc.

6110 NE 127th Ave.

Vancouver, WA 98682

360-896-0407

www.RoadmasterInc.com

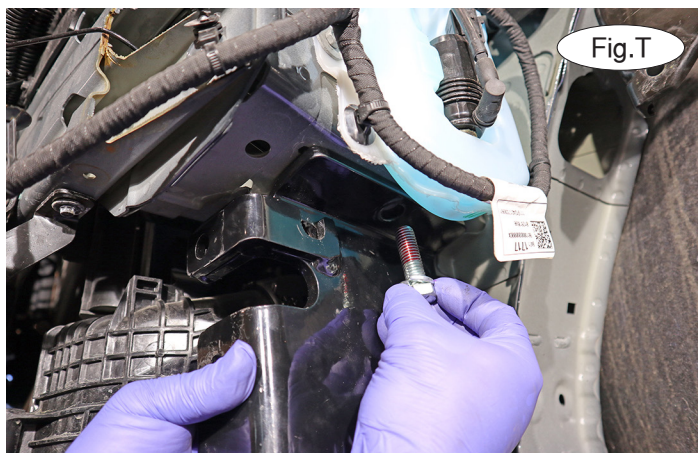

13. Place two small $\frac{1}{2}$ " flat washers and Loctite over two $\frac{1}{2}$ " x $1\frac{1}{2}$ " bolts. Bolt through the baseplate and pinch weld and finish with a $\frac{1}{2}$ " lock washer and $\frac{1}{2}$ " nut (Fig.U).

14. Using a $\frac{3}{4}$ " socket, tighten the upper bolts first and then the lower bolts using a $\frac{3}{4}$ " socket and wrench.

15. Repeat steps 11-14 for the passenger side but ensure that the cooling line nests into the cutout on the side-specific brace (Fig.V).

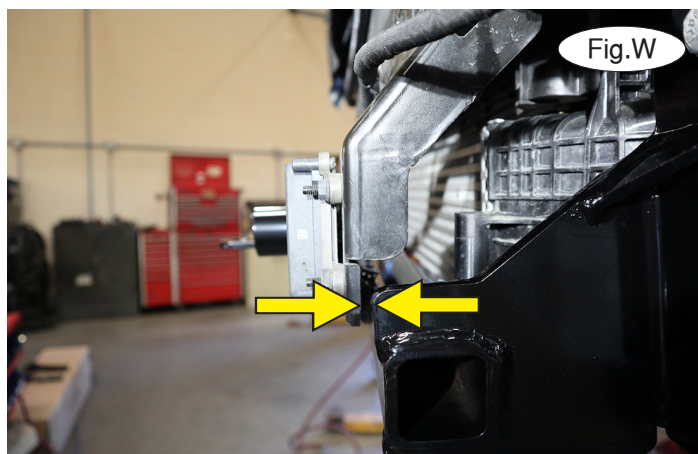

16. Place a small $\frac{1}{2}$ " flat washer and Loctite over two $\frac{1}{2}$ " x $1\frac{3}{4}$ " bolts. Then, with the help of a second person, lift the baseplate into place over the side-specific braces and bolt through the top mounts using the bolts you just prepared. Loosely finish the bolts with $\frac{1}{2}$ " lock washers and $\frac{1}{2}$ " nuts. *Note:* On the driver's side, ensure the brace is NOT contacting the ACC unit at the point indicated (Fig.W). If it is, slide the baseplate away from the unit. On the passenger side, ensure the brace is not contacting the cooling line at the point indicated (Fig.X – passenger side). If it is, bend it gently out of the way.





BASEPLATE KIT INSTALLATION INSTRUCTIONS

KIT# 523209-5

09/24
RS

ROADMASTER, Inc.

6110 NE 127th Ave.

Vancouver, WA 98682

360-896-0407

www.RoadmasterInc.com

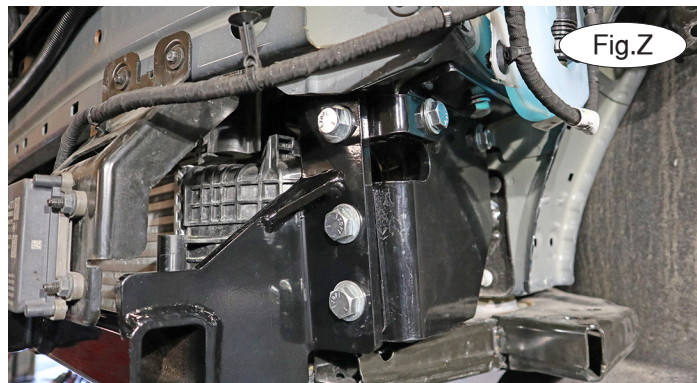
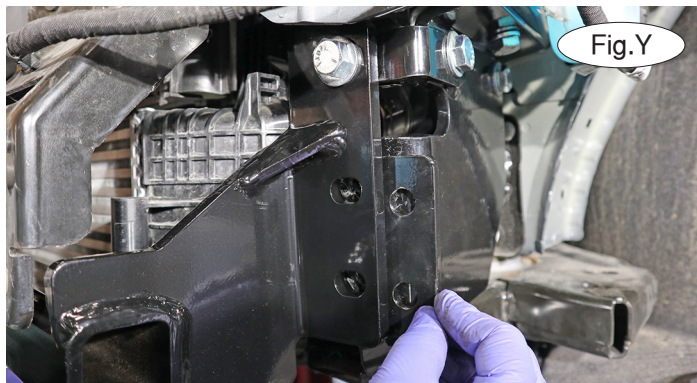

17. Now, prep four more $\frac{1}{2}$ " x $1\frac{3}{4}$ " bolts with $\frac{1}{2}$ " small flat washers and Loctite. Then, on each side, place a $\frac{1}{4}$ " x $1\frac{1}{2}$ " x 4" two-holed spacer plate between the side-specific brace and the baseplate (Fig.Y). Then, bolt through the baseplate, spacer plate and the side-specific brace. Finish each bolt with a $\frac{1}{2}$ " lock washer and $\frac{1}{2}$ " nut (Fig.Z). On each side, ensure that the baseplate is centered side-to-side. Tighten the top bolts using a $\frac{3}{4}$ " wrench and socket. Then, tighten the two lower bolts.



18. On each side, use a $\frac{17}{32}$ " drill bit to enlarge the existing outermost hole in the forward cross member (Fig. AA). Use caution so you don't drill into critical components.

19. Place a $\frac{1}{2}$ " lock washer, $\frac{1}{2}$ " flat washer and Loctite on two $\frac{1}{2}$ " x 3" bolts. On both sides, insert into the larger hole (second from the one you drilled) the cross member 1 x 1 $\frac{1}{2}$ " pipe spacer, push the spacer into the cross member then over so that it aligns with the newly drilled hole (Fig. A1).



19A. Refer to page 1 to locate the lower braces. For 2019 to 2022 models use the brace with the less angled end, for 2023 to 2025 models use the brace with the deeper angled end. On each side, slide the nutted end over the top of the hole you just enlarged (Fig.BB). Bolt up into it, ensuring that the forward part of the brace is on top (or bottom) of the main baseplate tab (Fig.CC). Fig A2 shows the install completed with a 2024 year model.

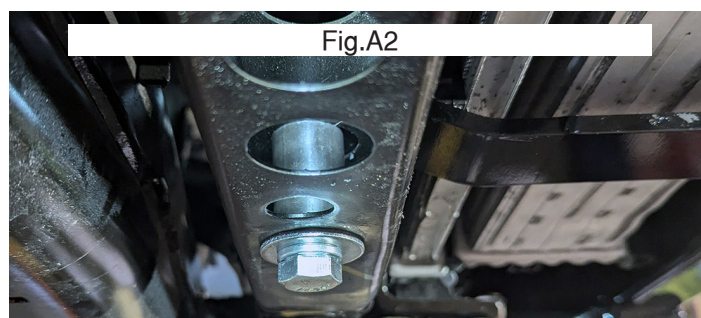
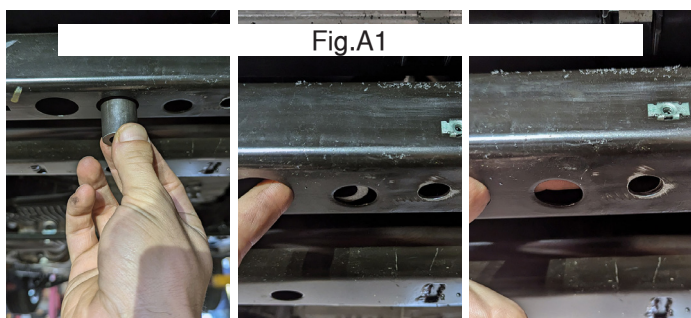



BASEPLATE KIT INSTALLATION INSTRUCTIONS

KIT# 523209-5

09/24
RS

ROADMASTER, Inc.

6110 NE 127th Ave.

Vancouver, WA 98682

360-896-0407

www.RoadmasterInc.com

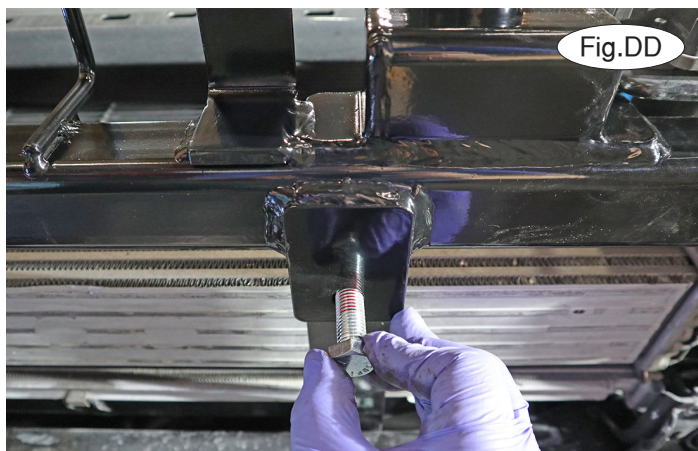

Fig.DD

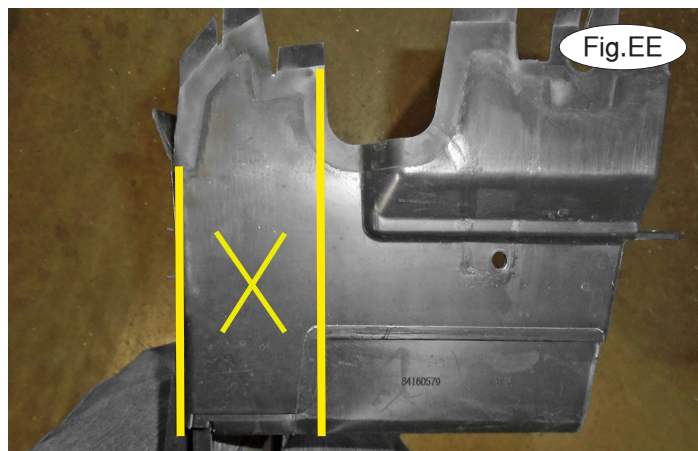

Fig.EE

20. Place Loctite on a $\frac{1}{2}$ " x $1\frac{1}{2}$ " bolt and bolt up through the main receiver brace tab, lower brace and finish with a $\frac{1}{2}$ " small flat washer, $\frac{1}{2}$ " lock washer and $\frac{1}{2}$ " nut (Fig.DD). Use a $\frac{3}{4}$ " socket to tighten the rear $\frac{1}{2}$ " bolts on each side and then use a $\frac{3}{4}$ " socket and wrench to tighten the front $\frac{1}{2}$ " hardware.



Fig.FF

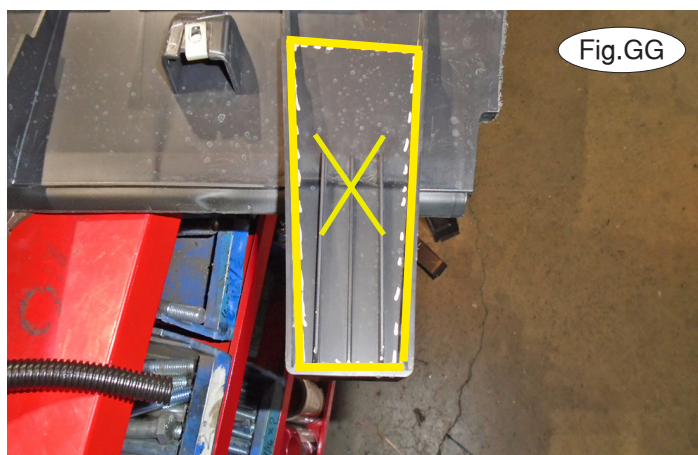

Fig.GG

21. On each side, trim out each section of the air dam indicated with an X, as shown in Figure EE. Figure FF shows it reinstalled. Trim the bottom of the air dam as shown in Figure GG. Figure HH shows the completed trimming of the bottom of the air dam.



Fig.HH



BASEPLATE KIT INSTALLATION INSTRUCTIONS

KIT# 523209-5

09/24
RS

ROADMASTER, Inc.

6110 NE 127th Ave.

Vancouver, WA 98682

360-896-0407

www.RoadmasterInc.com



Fig.II



Fig.JJ

22. On the back of the fascia, on the driver's side, remove the ambient temperature sensor mount. Trim it off as shown and then push in on the mount to release the sensor (Fig.II and JJ). Zip tie it to the wiring harness on the back of the fascia.

23. On each side, carefully remove the center rib on the outermost section of the lower grille opening (Fig.GG). *Note:* additional trimming is required on the driver's side shown due to the wiring rods.

24. Install the tow bar to the mounting bracket according to the manufacturer's instructions.



Fig.KK

IMPORTANT!

Safety cables are required by law. When towing, connect safety cables to the safety cable tabs illustrated in Figure LL. Make certain there is adequate slack in the cables to allow a full turning radius; otherwise, damage will result. If necessary, longer cables or cable extensions are available.



Fig.LL



BASEPLATE KIT INSTALLATION INSTRUCTIONS

KIT# 523209-5

09/24
RS

ROADMASTER, Inc.

6110 NE 127th Ave.

Vancouver, WA 98682

360-896-0407

www.RoadmasterInc.com

Three options for attaching the wiring plug to the main receiver brace

For six-wire plugs: use the two supplied 3/4" self-tapping screws to attach the electrical plug directly to the rods on the front of the main receiver brace.

For four-wire round plugs: attach to the plug mounting plate and then use the two supplied 3/4" self-tapping screws to attach the mounting plate to the rods on the front of the main receiver brace.

For four-wire flat plugs: place the plug through the mounting plug plate, and then secure it using the supplied zip tie on the front of the plug (Fig.MM). Use the two supplied 3/4" self-tapping screws to attach the mounting plate to the rods on the front of the main receiver brace.

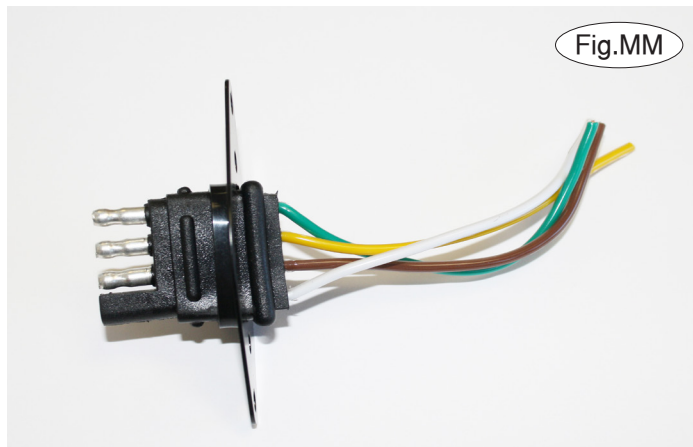

Fig.MM

BOLT TORQUE REQUIREMENTS

Note: The torque values represented below are intended as general guidelines. Torque requirements for specific applications may vary. Roadmaster does not warrant this information to be accurate for all applications and disclaims all liability for any claims or damages which may result from its use.

STANDARD BOLTS

Thread Size	Grade	Torque
5/16-18	5	13 ft./lb.
3/8-16	5	23 ft./lb.
7/16-14	5	37 ft./lb.
1/2-13	5	57 ft./lb.
5/8-11	5	112 ft./lb.

METRIC BOLTS

Thread Size	Grade	Torque
6mm-1.0	8.8	6 ft./lb.
8mm-1.0	8.8	18 ft./lb.
8mm-1.25	8.8	16 ft./lb.
10mm-1.25	8.8	36 ft./lb.
10mm-1.5	8.8	31 ft./lb.

METRIC BOLTS

Thread Size	Grade	Torque
12mm-1.25	8.8	64 ft./lb.
12mm-1.5	8.8	60 ft./lb.
12mm-1.75	8.8	55 ft./lb.
14mm-2.0	8.8	88 ft./lb.