



BASEPLATE KIT INSTALLATION INSTRUCTIONS

KIT# 523211-4

11/20/20
KS

ROADMASTER, Inc. 6110 NE 127th Ave. Vancouver, WA 98682 360-896-0407 fax 360-735-9300 www.roadmasterinc.com

Second person
Ratchets
7mm, 13, 15 and 17mm sockets
5/16" nut driver
T15 Torx driver or bit

What You'll Need

9/16" socket and wrench
Panel tool
Needlenose pliers

Medium flathead screwdriver
Tape measure
Torque wrench
Utility knife
Loctite© Red

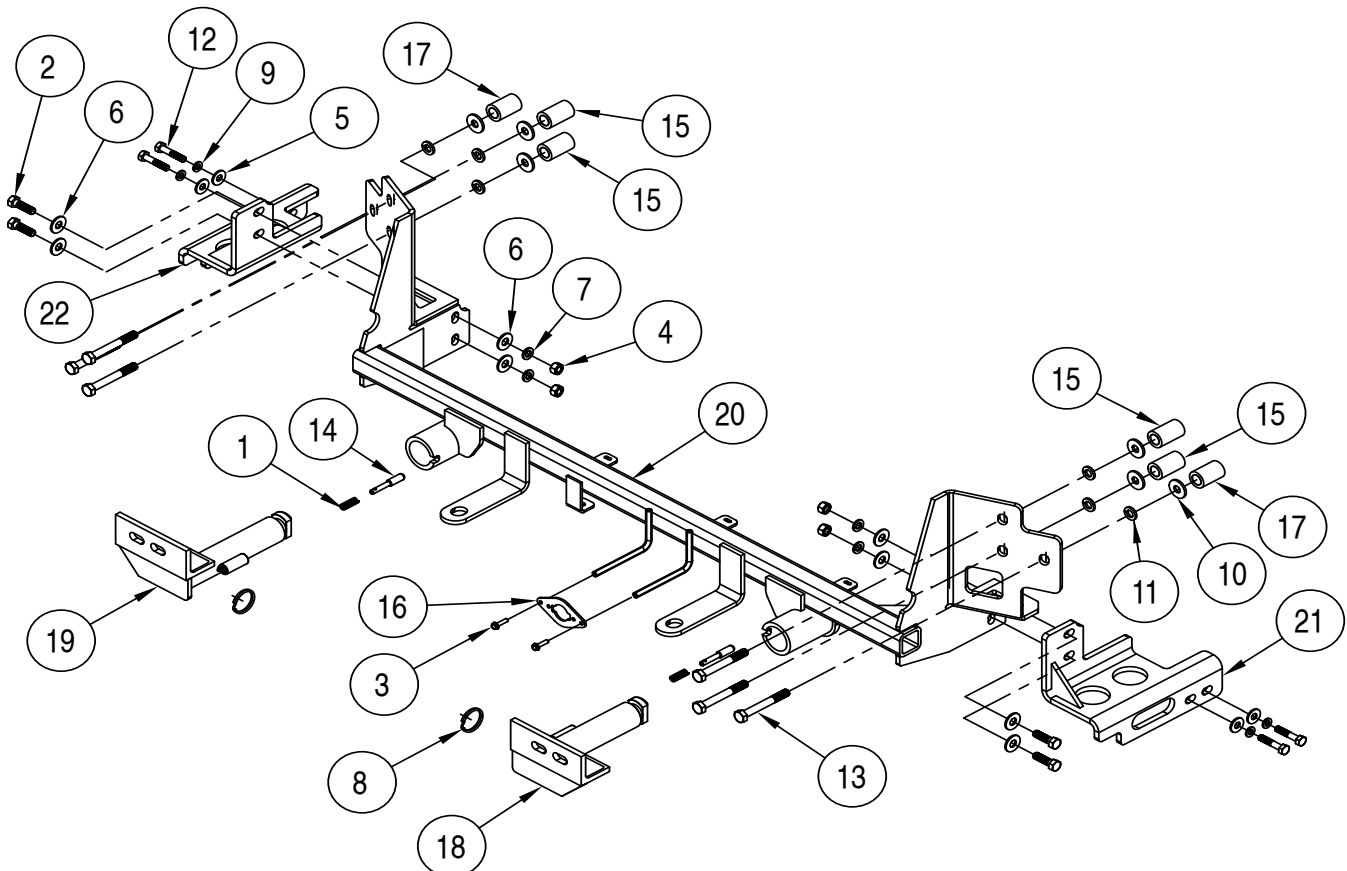

ITEM	QTY.	DESCRIPTION	PART NUMBER
1	2	SPRING	200146-00
2	4	3/8" x 1 1/4" BOLT	350056-00
3	2	#10 x 3/4" SELF DRILLING SCREW	350247-35
4	4	3/8" HEX NUT	350254-00
5	4	5/16" FLAT WASHER	350302-00
6	8	3/8" FLAT WASHER	350304-00
7	4	3/8" LOCK WASHER	350305-00
8	2	RING	350520-00
9	4	M8 LOCK WASHER	355705-00
10	6	M10 FLAT WASHER	355710-00
11	6	M10 LOCK WASHER	355715-00
12	4	M8 x 1.25 x 35 mm BOLT	356002-00
13	6	M10 x 1.5 x 75 mm BOLT	356114-00
14	2	LOCK PIN	A000008
15	4	1" O.D. x 0.188" WALL x 1 5/8" TUBE SPACER	A001442
16	1	WIRE PLUG PLATE	A003801
17	2	1" O.D. x 0.188" WALL x 1 1/2" TUBE SPACER	A002898
18	1	DRIVER SIDE ARM	C003585
19	1	PASSENGER SIDE ARM	C003586
20	1	MAIN RECEIVER	C003587
21	1	DRIVER SIDE BRACE	C003588
22	1	PASSENGER SIDE BRACE	C003589



BASEPLATE KIT INSTALLATION INSTRUCTIONS

KIT# 523211-4

11/20/20
KS

ROADMASTER, Inc. 6110 NE 127th Ave. Vancouver, WA 98682 360-896-0407 fax 360-735-9300 www.roadmasterinc.com

This is one of our crossbar-style baseplates, which allows the visible front portion of the bracket to be easily removed from the front of the vehicle (Fig.A and Fig.B).

The baseplate mounts to the frame of the vehicle and consists of a main receiver brace, two side-specific lower braces, two removable front braces, and a hardware pack.

Before starting the installation, lay out the kit components in order, as they will be used. This will give you a visual idea of how the components work, and will also confirm that everything is present and accounted for.



IMPORTANT: All baseplates **must** be assembled with all the bolts left loose for final adjustment and positioning (before tightening) unless otherwise instructed. All bolts **must** be torqued for proper strength. If more than one bolt is used per fastening point, the diagram may only show one. Use flat washers over all slotted holes and lock washers on all fasteners.

WARNING

Failure to heed these warnings or follow the installation instructions may result in a voided warranty, loss of towed vehicle, personal injury or death.

- Do not weld or modify this baseplate or its components. Welding or modification will void the warranty.
- Do not use this document as a basis to design/fabricate a baseplate, as it may not show all parts or structural components.
- We strongly recommend professional installation.
- If the towed vehicle has been in an accident, it must be properly repaired before attaching the baseplate. Do not install the baseplate if any structural frame damage is found.
- The installer must use all bolts and parts supplied. If running changes were made by the vehicle manufacturer after this kit was designed, some bolts or other fasteners may no longer be the correct size. It is the installer's responsibility to verify this kit is securely fastened to the vehicle.
- Use Loctite® Red on all bolts used to secure this baseplate. Torque all bolts to the specifications found at the end of these instructions. Do not over-torque the bolts or failure may occur.
- The installer must inspect the baseplate to ensure adequate clearance, particularly around hoses, air conditioner lines, radiators, etc. or non-warranty failure may result.
- Roadmaster manufactures many styles of baseplates. If your baseplate has removable arms, they must be removed before driving the vehicle, unless the arms can be pinned or padlocked in place. If not secured, the arms could vibrate out.
- Some motorhome chassis have such a tight turning radius that you can damage your motorhome, towed vehicle, tow bar or baseplate while turning sharply. Before getting on the road, test your turning radius in an empty parking lot. Turning too sharply could result in non-warranty damage to your towing system, motorhome and/or towed vehicle.
- Do not back up with the towed vehicle attached or non-warranty damage will occur to your towing system or vehicles.
- The safety cables must connect the towing vehicle to the towed vehicle frame to frame, with the cables crossed, with enough slack for sharp turns. See cable instructions for proper routing. Failure to do so will result in non-warranty damage and/or the loss of the towed vehicle.
- This kit is designed for use with ROADMASTER tow bars and ROADMASTER adapters only. Using this kit with other brands, without an approved ROADMASTER adapter, may result in non-warranty damage or injury.
- Receiver extensions and out-of-level towing situations of 3 inches or more. This can cause the system to swing much higher and lower, causing excessive strain on the tow bar, baseplate and frame. That can cause the towing system to fail, causing property damage, personal injury or even death. If you must use a receiver extension or drop hitch to tow, it will reduce your receiver's weight capacity by 1/3 to avoid damaging your system. Never use more than one extension and/or drop hitch, as this will void your warranty.
- Every 3,000 miles, the owner must inspect all mounting points for cracks or fatigue, and check the fasteners for proper torque, according to the bolt torque requirements chart on the last page of these instructions.
- The owner must follow the vehicle manufacturer's instructions to prepare the vehicle for towing. Failure to do so may cause severe damage to the vehicle.
- This baseplate is only warranted for the original installation. Installing a used baseplate on another vehicle is not recommended and will void the warranty.



BASEPLATE KIT INSTALLATION INSTRUCTIONS

KIT# 523211-4

11/20/20
KS

ROADMASTER, Inc. 6110 NE 127th Ave. Vancouver, WA 98682 360-896-0407 fax 360-735-9300 www.roadmasterinc.com

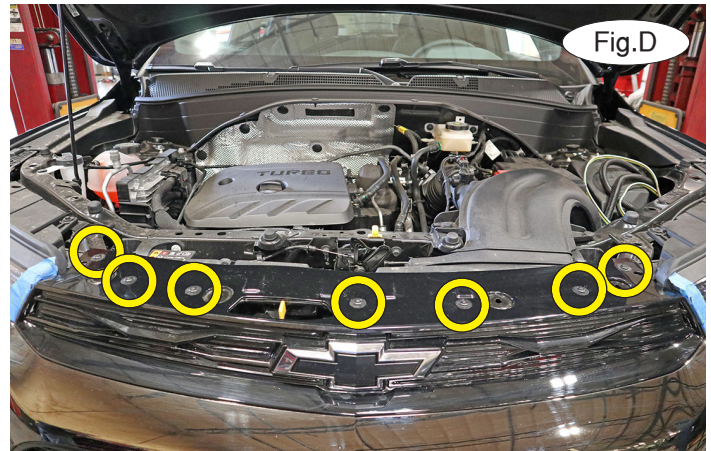

Important: Please use all supplied hardware and read through these instructions carefully before beginning this installation. The majority of questions you may have can be answered within the text, and proper installation will ensure safe and secure travel.

1. Remove the four indicated bump stops by applying gentle upward pressure while turning counter-clockwise (Fig.C).
2. Remove seven T15 screws attaching the top of the fascia to the core support (Fig.D).

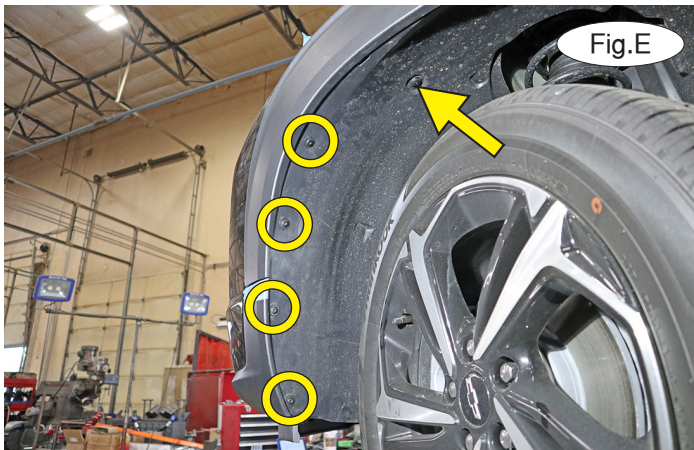

3. On each side, remove four T15 screws and one plastic fastener attaching the fender liner to the fascia (Fig.E).
4. On each side, remove two T15 screws attaching the bottom of the fender liner to the bottom of the fascia (Fig.F).
5. On each side, remove three 7mm screws and one plastic fastener attaching the splash guard to the subframe (Fig.G – driver's side).

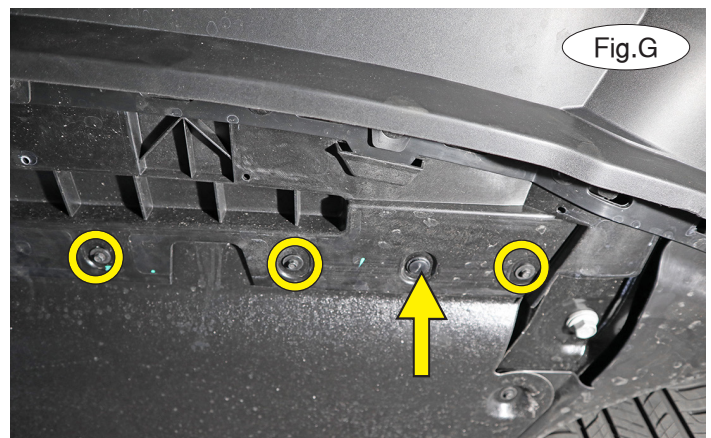

All illustrations and specifications contained herein are based on the latest information available at the time of publication approval. ROADMASTER, INC. reserves the right to make changes at any time without notice in material, specification and models or to discontinue models.



BASEPLATE KIT INSTALLATION INSTRUCTIONS

KIT# 523211-4

11/20/20
KS

ROADMASTER, Inc. 6110 NE 127th Ave. Vancouver, WA 98682 360-896-0407 fax 360-735-9300 www.roadmasterinc.com

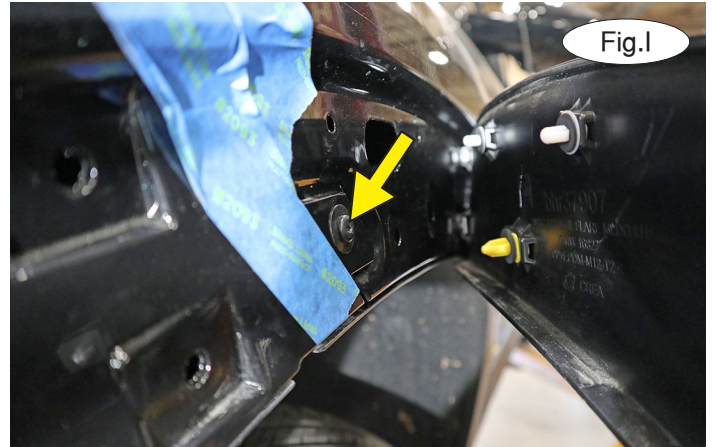
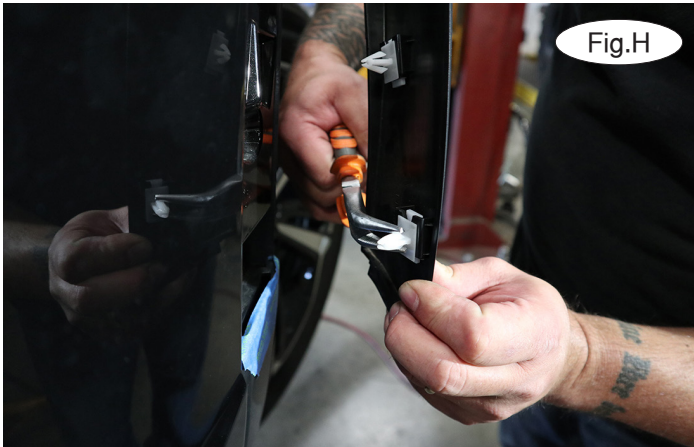

6. On each side, pull back the fender liner and, using a pair of pliers, release the arrowhead clips until you reach the yellow clip, or about halfway back on the trim piece. Figure H shows how to release the clips. Then, remove the T15 screw attaching the top corner of the fascia to the bottom corner of the fender (Fig.I).

7. With the assistance of a second person, pull out on the corners of the fascia to remove it (Fig.J). Disconnect any wiring harnesses and/or fog lights, if the vehicle is so equipped, and set the fascia aside for now.

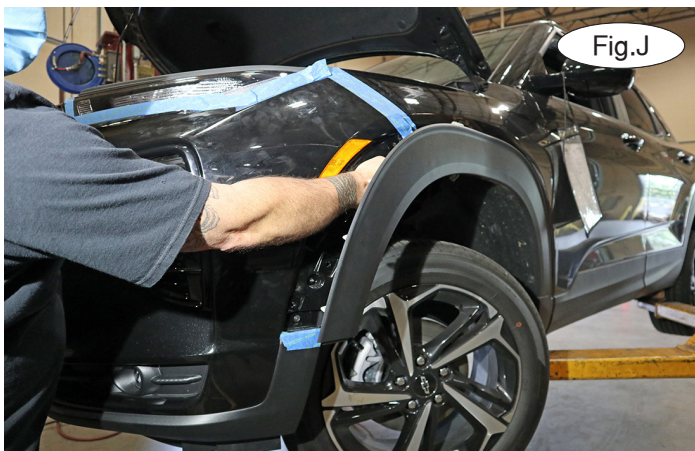

8. On each side, separate the upper and lower halves of the air dam as indicated in Figure K (yellow line, driver's side).

9. On each side, use a flathead screwdriver to push upward while pulling gently outward on the air dam mount tabs to release the air dam (Fig.L and Fig.M). It will not be replaced.

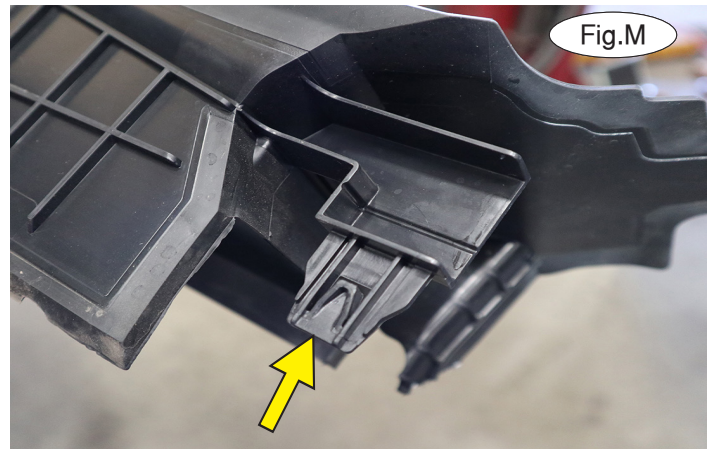



BASEPLATE KIT INSTALLATION INSTRUCTIONS

KIT# 523211-4

11/20/20
KS

ROADMASTER, Inc. 6110 NE 127th Ave. Vancouver, WA 98682 360-896-0407 fax 360-735-9300 www.roadmasterinc.com

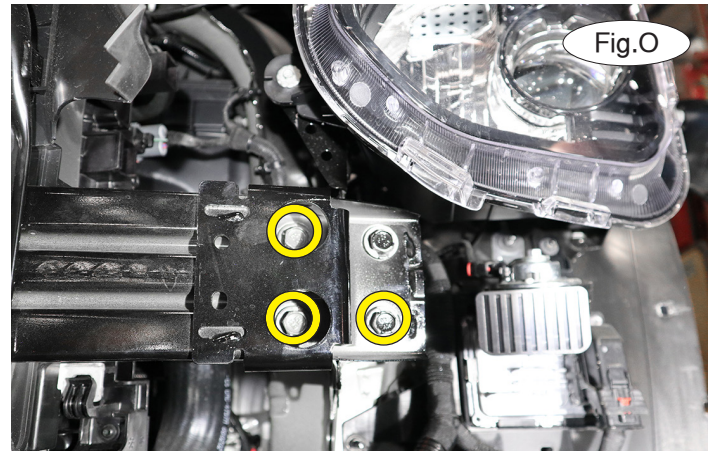
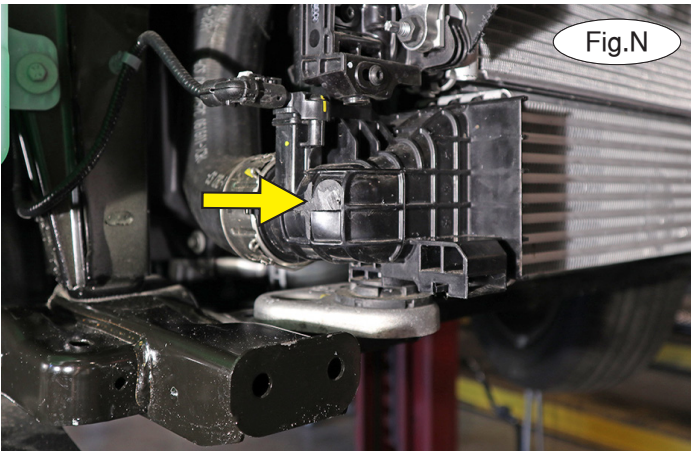

11. On the passenger side only, trim the plastic nub flush with the intercooler intake housing (Fig.N).
 12. On each side, permanently remove three 15mm bolts attaching the bumper core to the frame ends (Fig.O).
 13. On each side, place two 1" O.D. x .188 wall x 1-5/8" pipe spacers over the innermost bumper core mounts (Fig.P).
- Note:** Ensure you measure the pipe spacers before installing them, as this kit includes two different sizes.

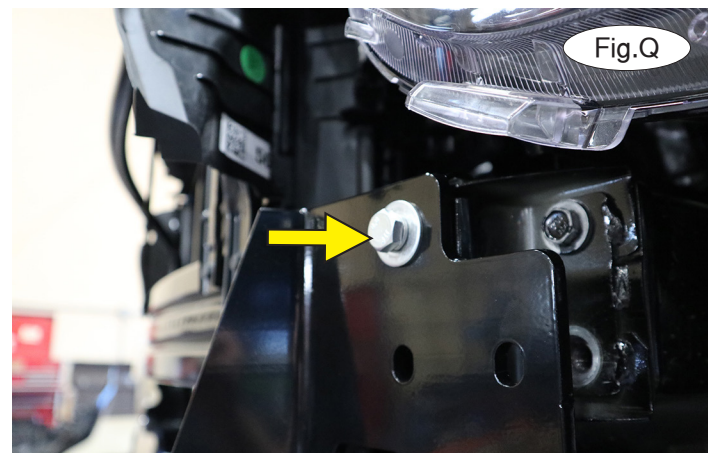
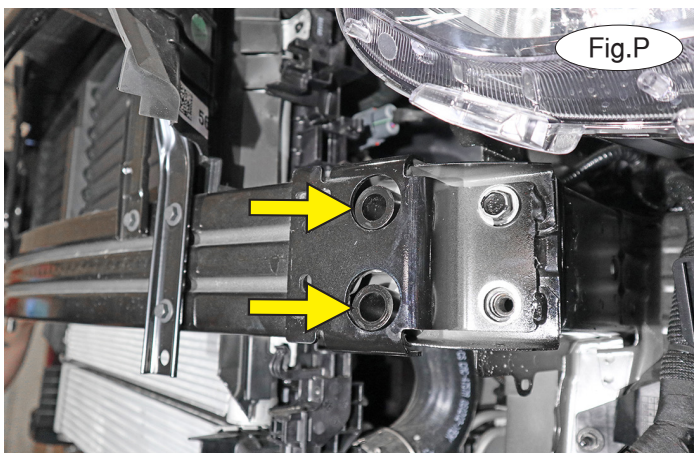

14. Prepare six M10 x 1.5 x 75mm bolts with M10 lock washers, M10 flat washers, and Loctite. Now, with the assistance of a second person, hold the baseplate over the bumper core mounts and the pipe spacers you installed in the previous step and install the M10 bolts in the upper mounts only (Fig.Q). Then, on each side, install the bolt directly below it (Fig.R). On each side, place a 1" O.D. x .188 wall x 1½" pipe spacer between the bumper core mount and the baseplate, and install the final M10 bolt (Fig.S).

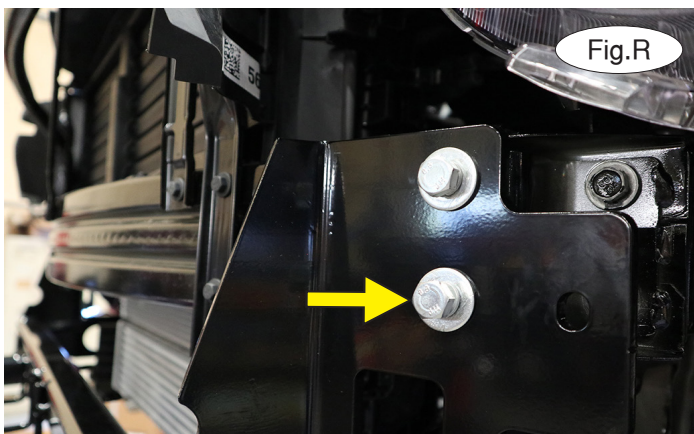



BASEPLATE KIT INSTALLATION INSTRUCTIONS

KIT# 523211-4

11/20/20
KS

ROADMASTER, Inc. 6110 NE 127th Ave. Vancouver, WA 98682 360-896-0407 fax 360-735-9300 www.roadmasterinc.com

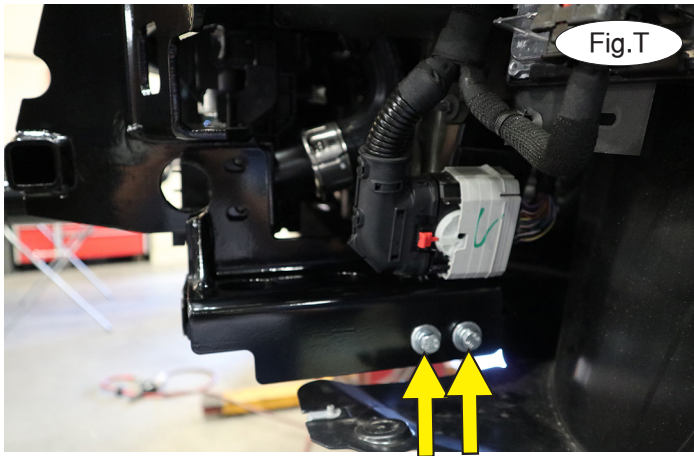

15. Working on the driver's side only, prepare two M8 x 1.25 x 35mm bolts with M8 lock washers, 5/16" flat washers and Loctite. Using the drawing on page 1 as a reference, locate the driver's side-specific lower brace. Hold it in place and loosely thread the two bolts into the factory nuts (Fig.T). Place two 3/8" flat washers and Loctite over two 3/8" x 1/4" bolts. Then, use them to secure the side-specific brace to the baseplate (Fig.U). Finish with the supplied 3/8" flat washers, 3/8" lock washers and 3/8" nuts.

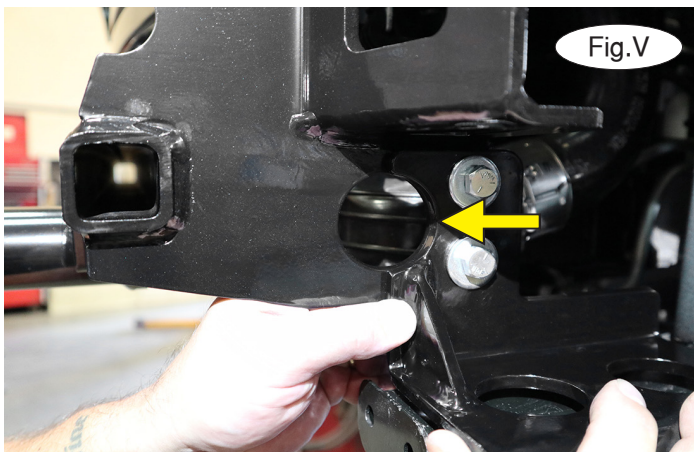

16. Repeat step 15 for the passenger side. *Note:* Due to clearance issues, it may be helpful to hold the nut in place and thread the bolt onto it.

17. Apply upward pressure on each corner of the baseplate and then tighten the M10 bolts.

18. Ensure that each side-specific brace is level and that the large, circular cutouts align (Fig.V), and then tighten the 3/8" hardware and M8 hardware.

19. Permanently remove the shock absorption pad from the back of the fascia by releasing two plastic clips on each side (Fig.W) and pulling upward to remove the pad. Then, trim the lower mounts flush (Fig.X).

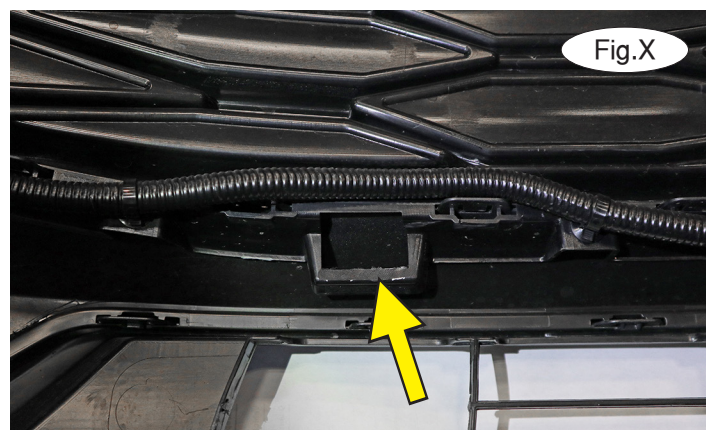



BASEPLATE KIT INSTALLATION INSTRUCTIONS

KIT# 523211-4

11/20/20
KS

ROADMASTER, Inc. 6110 NE 127th Ave. Vancouver, WA 98682 360-896-0407 fax 360-735-9300 www.roadmasterinc.com

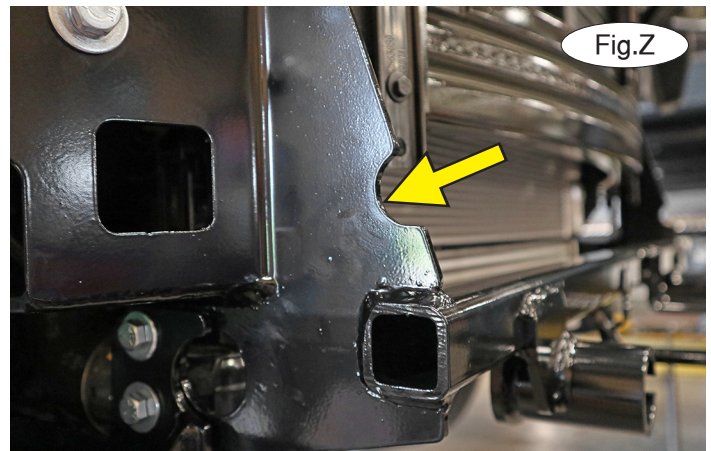
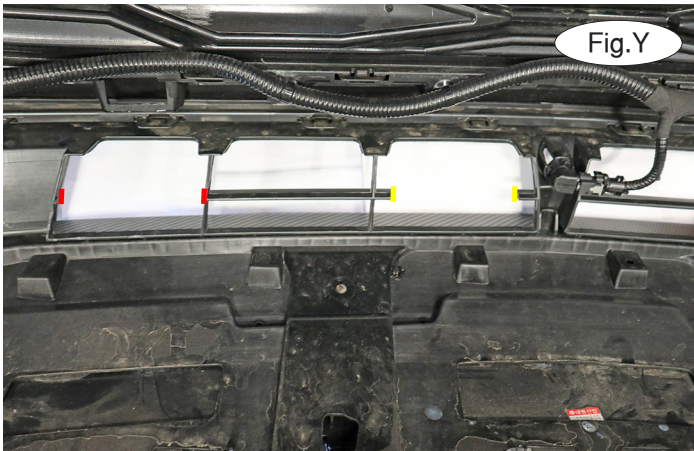

20. On each side, trim the outermost rib on the fascia (Fig.Y – red lines). Figure Y shows the completed trimming for the driver's side. Note: The inside rib that is offset to the driver's side will also need to be trimmed to allow clearance for the wiring plug rods. Leave approximately ½" of the rib on each side (Fig.Y – yellow lines).

21. Reinstall the fascia by reversing steps 1 through 7. *Note:* Ensure that the wiring harness attached to the back of the fascia nests in the provided cutouts on the baseplate (Fig.Z).

22. Install the tow bar to the baseplate according to the manufacturer's instructions.

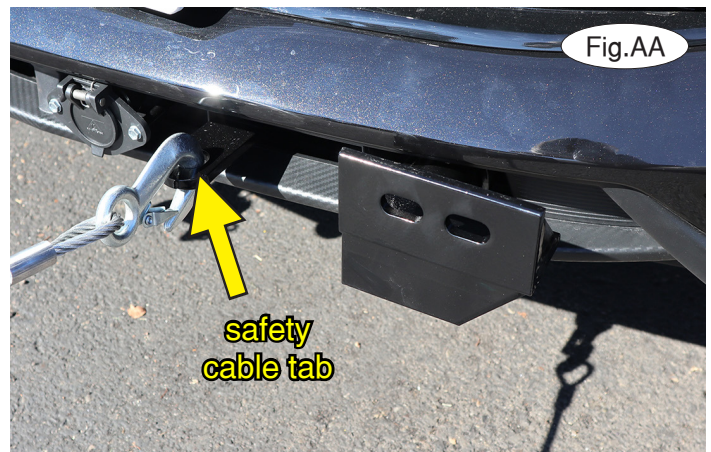

IMPORTANT!

Safety cables are required by law. When towing, connect safety cables to the safety cable tabs illustrated in Figure AA. Make certain there is adequate slack in the cables to allow a full turning radius; otherwise, damage will result. If necessary, longer cables or cable extensions are available.



BASEPLATE KIT INSTALLATION INSTRUCTIONS

KIT# 523211-4

11/20/20
KS

ROADMASTER, Inc. 6110 NE 127th Ave. Vancouver, WA 98682 360-896-0407 fax 360-735-9300 www.roadmasterinc.com

Three options for attaching the wiring plug to the main receiver brace

For six-wire plugs: use the two supplied 3/4" self-tapping screws to attach the electrical plug directly to the rods on the front of the main receiver brace.

For four-wire round plugs: attach to the plug mounting plate and then use the two supplied 3/4" self-tapping screws to attach the mounting plate to the rods on the front of the main receiver brace.

For four-wire flat plugs: place the plug through the mounting plug plate, and then secure it using the supplied zip tie on the front of the plug (Fig.BB). Use the two supplied 3/4" self-tapping screws to attach the mounting plate to the rods on the front of the main receiver brace.

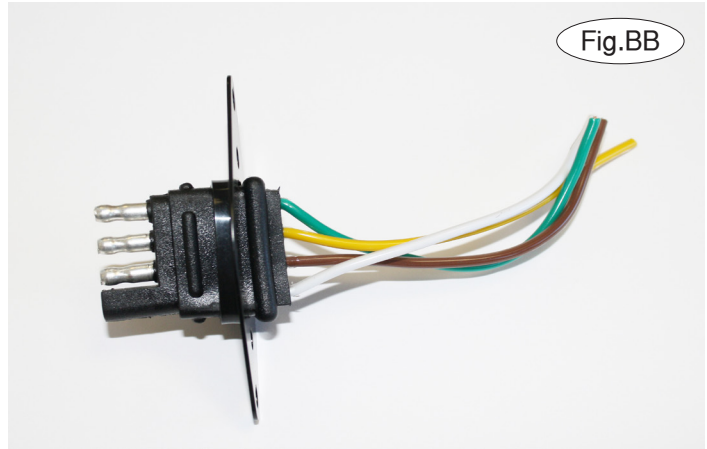

Fig.BB

BOLT TORQUE REQUIREMENTS

Note: The torque values represented below are intended as general guidelines. Torque requirements for specific applications may vary. Roadmaster does not warrant this information to be accurate for all applications and disclaims all liability for any claims or damages which may result from its use.

STANDARD BOLTS

Thread Size	Grade	Torque
5/16-18	5	13 ft./lb.
3/8-16	5	23 ft./lb.
7/16-14	5	37 ft./lb.
1/2-13	5	57 ft./lb.
5/8-11	5	112 ft./lb.

METRIC BOLTS

Thread Size	Grade	Torque
6mm-1.0	8.8	6 ft./lb.
8mm-1.0	8.8	18 ft./lb.
8mm-1.25	8.8	16 ft./lb.
10mm-1.25	8.8	36 ft./lb.
10mm-1.5	8.8	31 ft./lb.

METRIC BOLTS

Thread Size	Grade	Torque
12mm-1.25	8.8	64 ft./lb.
12mm-1.5	8.8	60 ft./lb.
12mm-1.75	8.8	55 ft./lb.
14mm-2.0	8.8	88 ft./lb.

All illustrations and specifications contained herein are based on the latest information available at the time of publication approval. ROADMASTER, INC. reserves the right to make changes at any time without notice in material, specification and models or to discontinue models.