



BASEPLATE KIT INSTALLATION INSTRUCTIONS

KIT# 523219-4

03/08/23
KS

ROADMASTER, Inc. 6110 NE 127th Ave. Vancouver, WA 98682 360-896-0407 fax 360-735-9300 www.roadmasterinc.com

Ratchet and extensions
7, 10, 15, and 18mm sockets
18mm wrench
Panel tool

What You'll Need

T15 Torx screwdriver or bit

Reciprocating saw
Torque wrench
Loctite© Red
Permanent marker

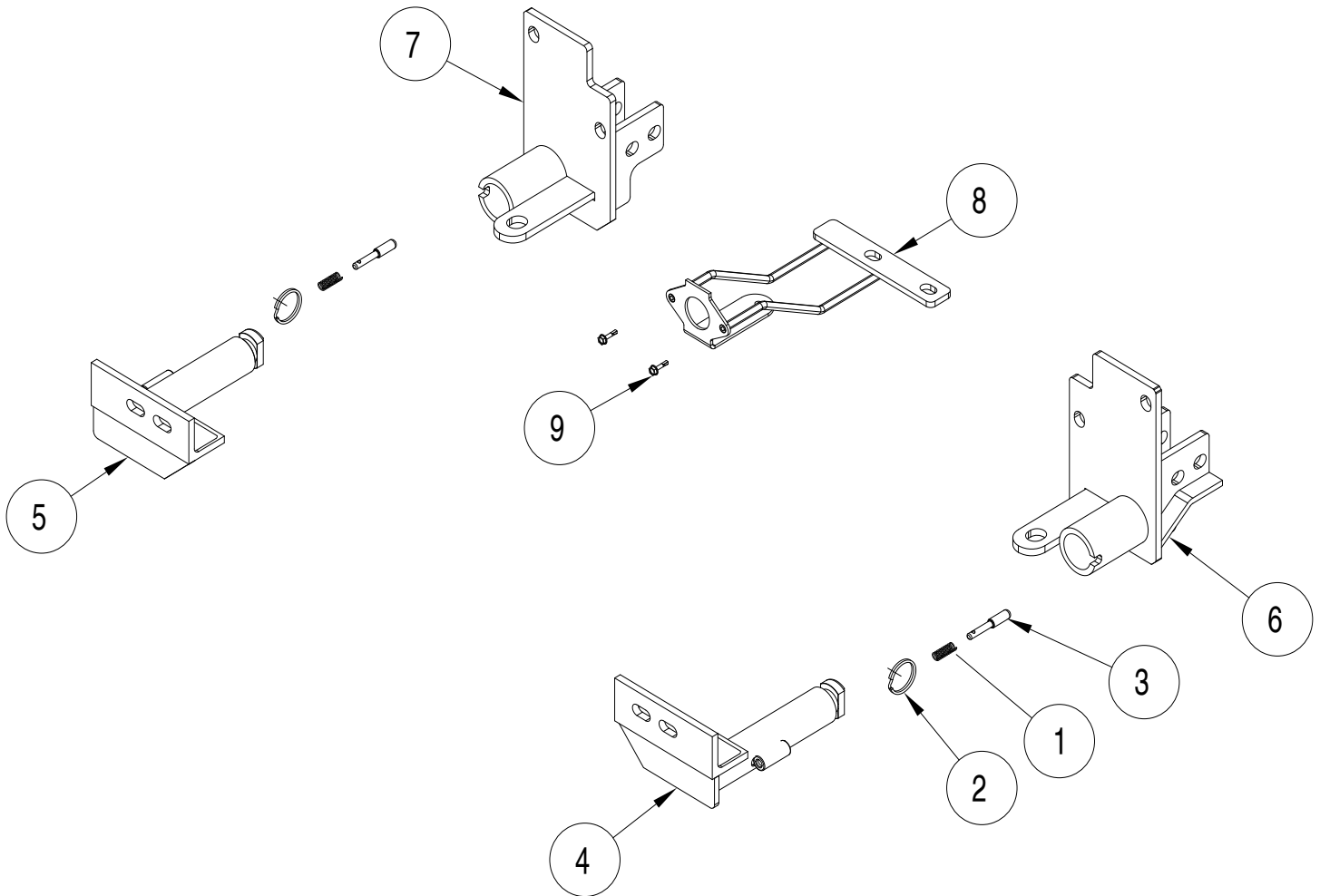

ITEM	QTY	DESCRIPTION	PART NUMBER
1	2	SPRING	200146-00
2	2	RING	350520-00
3	2	LOCK PIN	A000008
4	1	DRIVER SIDE ARM	C003569
5	1	PASSENGER SIDE ARM	C003570
6	1	DRIVER SIDE RECEIVER	C003571
7	1	PASSENGER SIDE RECEIVER	C003572
8	1	WIRE PLUG BRACKET	C003600
9	2	#10 x 3/4" SELF DRILLING SCREW	350247-35



BASEPLATE KIT INSTALLATION INSTRUCTIONS

KIT# 523219-4

03/08/23
KS

ROADMASTER, Inc. 6110 NE 127th Ave. Vancouver, WA 98682 360-896-0407 fax 360-735-9300 www.roadmasterinc.com

This is one of our crossbar-style baseplates, which allows the visible front portion of the bracket to be easily removed from the front of the vehicle (Fig.A and Fig.B).

The baseplate mounts to the side-specific braces and the frame of the vehicle, and consists of two side-specific braces, two removable front braces, and a hardware pack.

Before starting the installation, lay out the kit components in order, as they will be used. This will give you a visual idea of how the components work, and will also confirm that everything is present and accounted for.



IMPORTANT: All baseplates **must** be assembled with all the bolts left loose for final adjustment and positioning (before tightening) unless otherwise instructed. All bolts **must** be torqued for proper strength. If more than one bolt is used per mounting point, the diagram may only show one. Use flat washers over all slotted holes and lock washers on all fasteners.

WARNING

Failure to heed these warnings or follow the installation instructions may result in a voided warranty, loss of towed vehicle, personal injury or death.

- Do not weld or modify this baseplate or its components. Welding or modification will void the warranty.
- Do not use this document as a basis to design/fabricate a baseplate, as it may not show all parts or structural components.
- We strongly recommend professional installation.
- If the towed vehicle has been in an accident, it must be properly repaired before attaching the baseplate. Do not install the baseplate if any structural frame damage is found.
- The installer must use all bolts and parts supplied. If running changes were made by the vehicle manufacturer after this kit was designed, some bolts or other fasteners may no longer be the correct size. It is the installer's responsibility to verify this kit is securely fastened to the vehicle.
- Use Loctite® Red on all bolts used to secure this baseplate. Torque all bolts to the specifications found at the end of these instructions. Do not over-torque the bolts or failure may occur.
- The installer must inspect the baseplate to ensure adequate clearance, particularly around hoses, air conditioner lines, radiators, etc. or non-warranty failure may result.
- Roadmaster manufactures many styles of baseplates. If your baseplate has removable arms, they must be removed before driving the vehicle, unless the arms can be pinned or padlocked in place. If not secured, the arms could vibrate out.
- Some motorhome chassis have such a tight turning radius that you can damage your motorhome, towed vehicle, tow bar or baseplate while turning sharply. Before getting on the road, test your turning radius in an empty parking lot. Turning too sharply could result in non-warranty damage to your towing system, motorhome and/or towed vehicle.
- Do not back up with the towed vehicle attached or non-warranty damage will occur to your towing system or vehicles.
- The safety cables must connect the towing vehicle to the towed vehicle frame to frame, with the cables crossed, with enough slack for sharp turns. See cable instructions for proper routing. Failure to do so will result in non-warranty damage and/or the loss of the towed vehicle.
- This kit is designed for use with ROADMASTER tow bars and ROADMASTER adapters only. Using this kit with other brands, without an approved ROADMASTER adapter, may result in non-warranty damage or injury.
- Receiver extensions and out-of-level towing situations of 3 inches or more. This can cause the system to swing much higher and lower, causing excessive strain on the tow bar, baseplate and frame. That can cause the towing system to fail, causing property damage, personal injury or even death. If you must use a receiver extension or drop hitch to tow, it will reduce your receiver's weight capacity by 1/3 to avoid damaging your system. Never use more than one extension and/or drop hitch, as this will void your warranty.
- Every 3,000 miles, the owner must inspect all mounting points for cracks or fatigue, and check the fasteners for proper torque, according to the bolt torque requirements chart on the last page of these instructions.
- The owner must follow the vehicle manufacturer's instructions to prepare the vehicle for towing. Failure to do so may cause severe damage to the vehicle.
- This baseplate is only warranted for the original installation. Installing a used baseplate on another vehicle is not recommended and will void the warranty.



BASEPLATE KIT INSTALLATION INSTRUCTIONS

KIT# 523219-4

03/08/23
KS

ROADMASTER, Inc. 6110 NE 127th Ave. Vancouver, WA 98682 360-896-0407 fax 360-735-9300 www.roadmasterinc.com

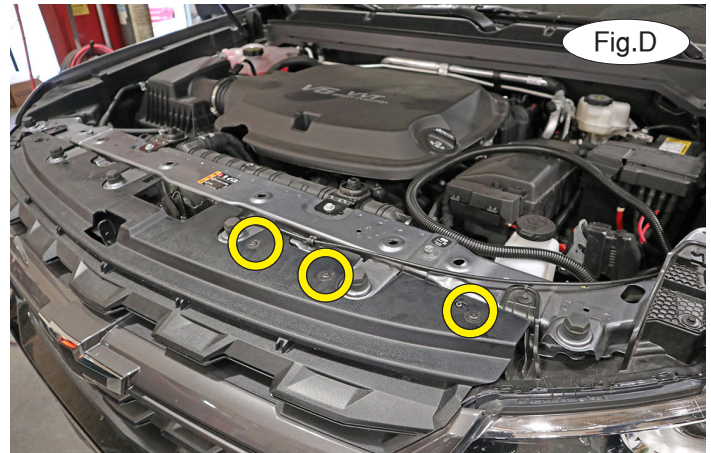
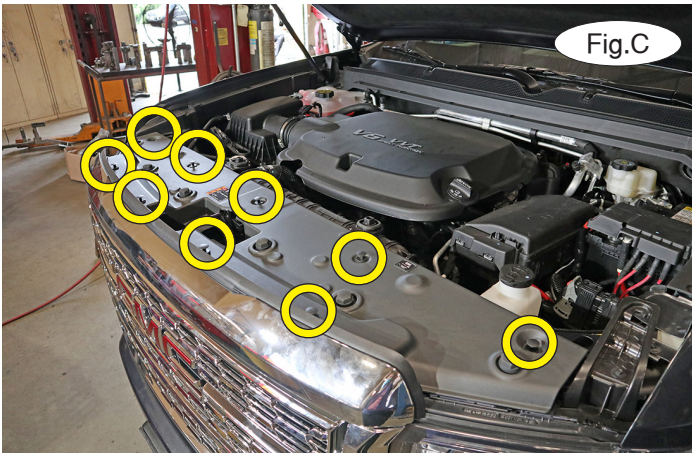

Important: Please use all supplied hardware and read through these instructions carefully before beginning this installation. The majority of questions you may have can be answered within the text, and proper installation will ensure safe and secure travel.

1. **For Colorado models:** Proceed to step 2. **For Canyon models:** Remove nine plastic fasteners attaching the radiator cover to the core support and fascia (Fig.C). Set the radiator cover aside for now.

2. **For Colorado models:** On each side, remove three T15 screws attaching the top of the fascia to the core support (Fig.D). **For Canyon models:** On each side, remove three T15 screws (Fig.E – circles) and one plastic fastener (Fig.E – arrow) attaching the fascia to the core support.

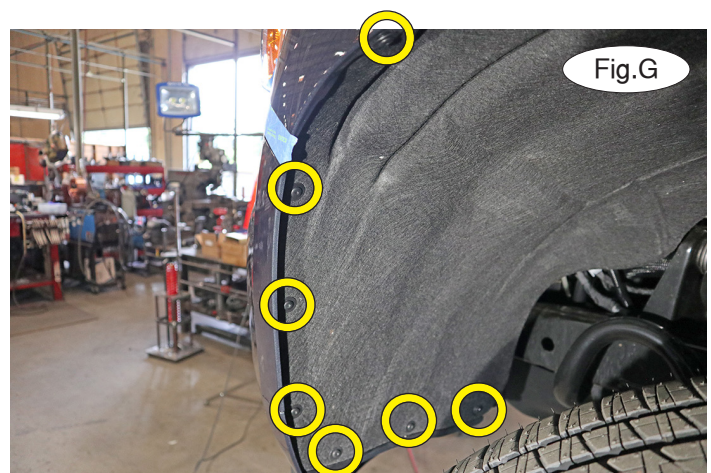
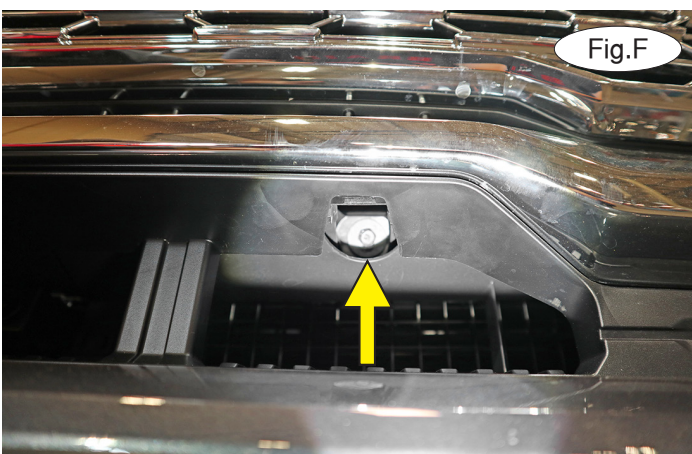
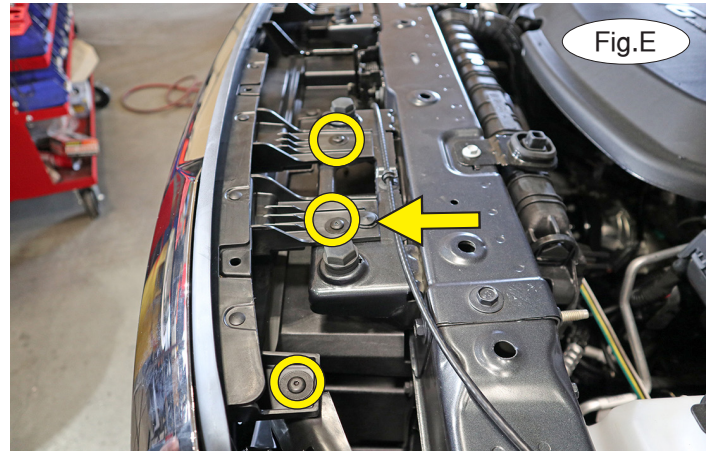

3. On each side, remove one 10mm bolt attaching the fascia to the shutter housing (Fig.F – driver's side).

4. Working on the driver's side only, turn the wheel to the outside of the vehicle and remove seven T15 screws attaching the fender liner to the fender and the fascia (Fig.G).



BASEPLATE KIT INSTALLATION INSTRUCTIONS

KIT# 523219-4

03/08/23
KS

ROADMASTER, Inc. 6110 NE 127th Ave. Vancouver, WA 98682 360-896-0407 fax 360-735-9300 www.roadmasterinc.com

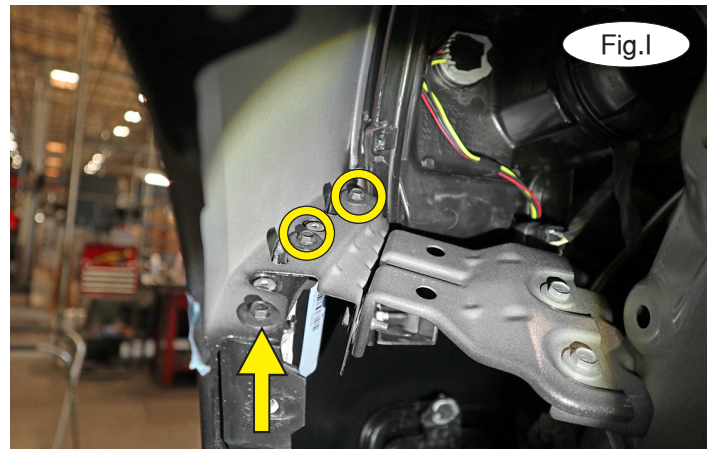
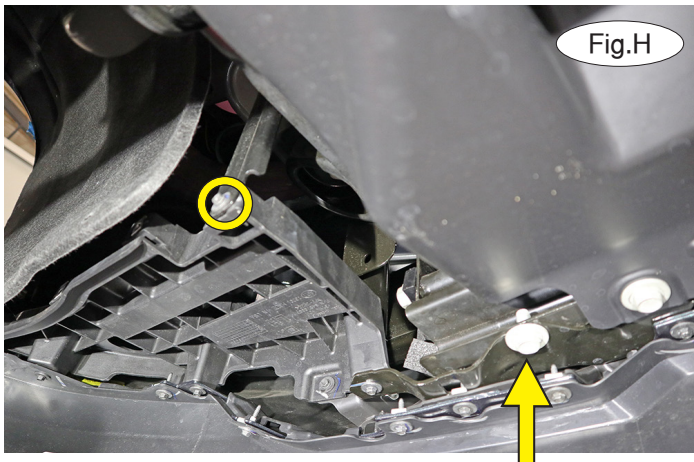

5. Remove one 7mm screw (Fig.H – circle) and one 15mm bolt (Fig.H – arrow) attaching the fascia to the frame.

6. Repeat steps 4 and 5 for the passenger side of the vehicle.

7. Utilize the help of a second person to avoid dropping the fascia before proceeding. **For Colorado models:** On each side, remove one 7mm screw attaching the top corner of the fascia to the fender (Fig.I – arrow). **For Canyon models:** On each side, remove all three 7mm screws (Fig.I – arrow and circles).

8. Pull up on the top of the fascia and down and out on the corner to release the locating clips. Then, pull out firmly to remove the fascia (Fig.J). Disconnect the fog lights, if the vehicle is so equipped. Set the fascia aside for now.

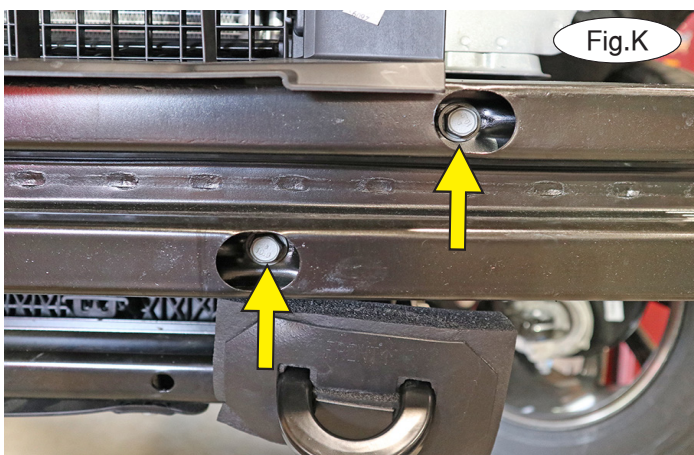
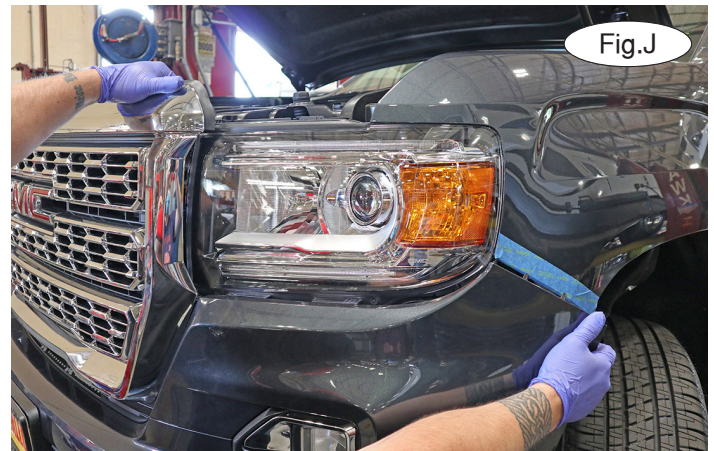

9. On each side, remove two 15mm bolts attaching the bumper core to the frame (Fig.K). Set it aside for now.

10. Remove three plastic fasteners attaching the lower air dam to the core support (Fig.L). Apply gentle but consistent pressure to release the remaining clips. Set the lower air dam aside for now.

All illustrations and specifications contained herein are based on the latest information available at the time of publication approval. ROADMASTER, INC. reserves the right to make changes at any time without notice in material, specification and models or to discontinue models.



BASEPLATE KIT INSTALLATION INSTRUCTIONS

KIT# 523219-4

03/08/23
KS

ROADMASTER, Inc. 6110 NE 127th Ave. Vancouver, WA 98682 360-896-0407 fax 360-735-9300 www.roadmasterinc.com

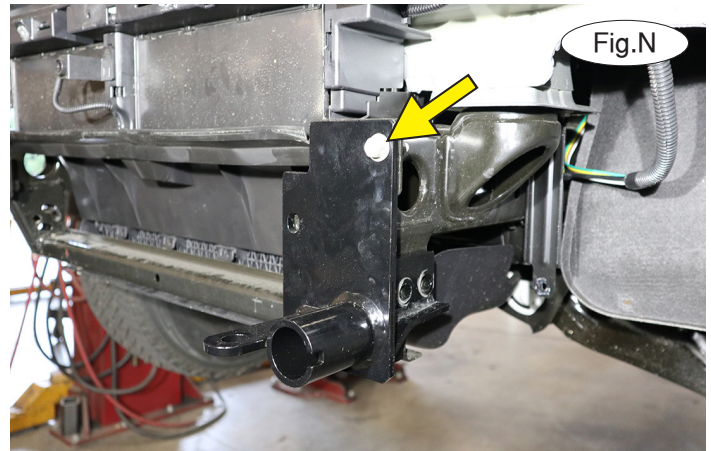
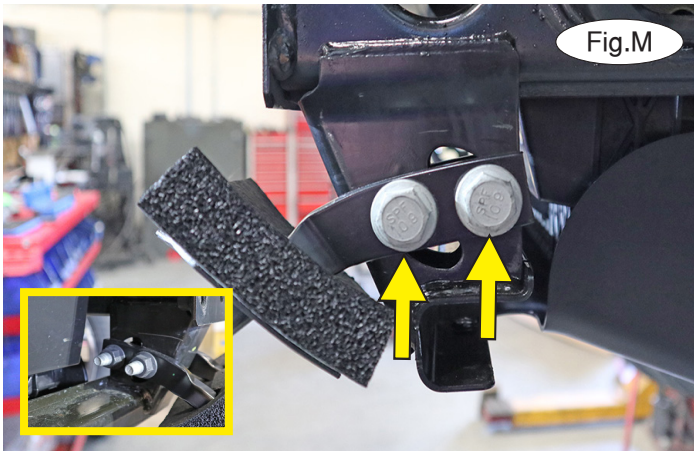

11. Working on the driver's side only, use an 18mm socket and wrench to remove the two bolts attaching the tow hook to the frame (Fig.M and Fig.M – inset). Retain the hardware for a future step but the tow hooks will not be replaced.

12. Use the drawing on page 1 to locate the driver's side-specific brace. The safety cable tab should be set to the inside. Slide the lower section over the tow hook mounts and reinstall the upper bolt you removed in step 9 to temporarily hold the brace in place (Fig.N).

13. Place Loctite over two of the 18mm tow hook mounting bolts you removed in step 11. Then, use them to bolt through the two lower mounts of the side-specific brace, through the tow hook mounts and finish with the nuts you removed in step 11 (Fig.O). Tighten the bolts to the manufacturer's requirements. Then, remove the upper bolt you temporarily installed in step 12.

14. Repeat steps 11 through 13 for the passenger side of the vehicle.

15. Replace the bumper core by rolling it down over the side-specific braces (Fig.P) and letting it rest on the receivers. Place Loctite over the 15mm bolts you removed in step 9 and bolt through the bumper core, side-specific brace and into the factory mounts (Fig.Q). Tighten the bolts to the manufacturer's requirements.

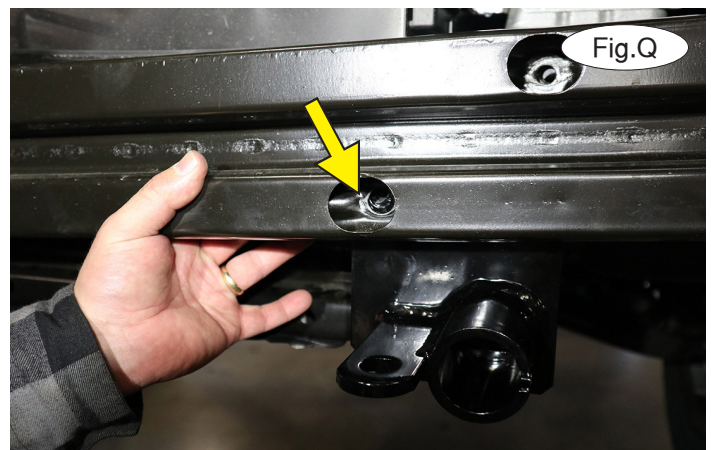
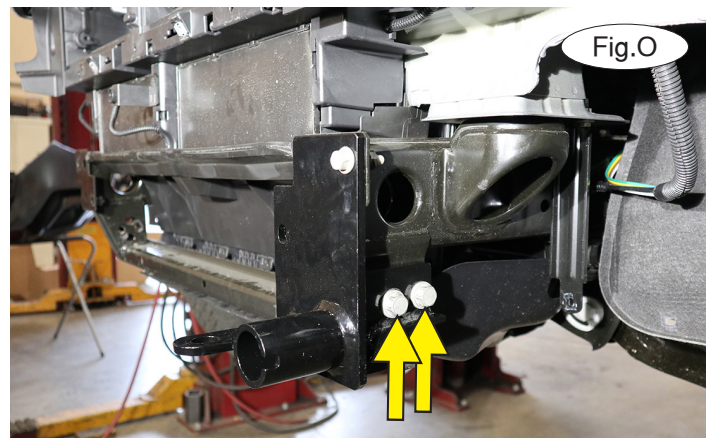

All illustrations and specifications contained herein are based on the latest information available at the time of publication approval. ROADMASTER, INC. reserves the right to make changes at any time without notice in material, specification and models or to discontinue models.



BASEPLATE KIT INSTALLATION INSTRUCTIONS

KIT# 523219-4

03/08/23
KS

ROADMASTER, Inc. 6110 NE 127th Ave. Vancouver, WA 98682 360-896-0407 fax 360-735-9300 www.roadmasterinc.com

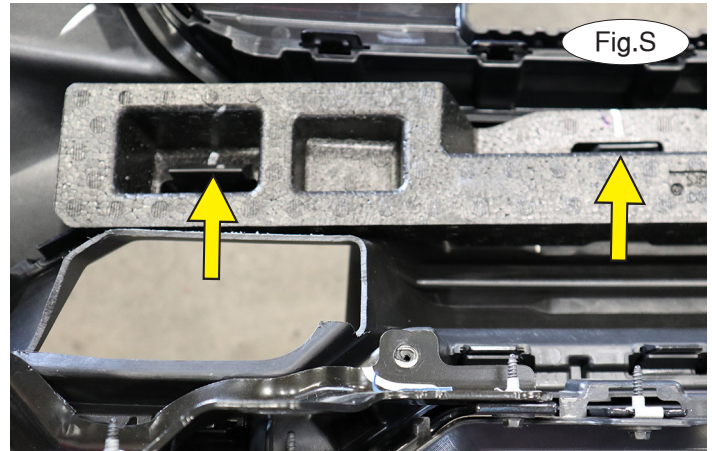
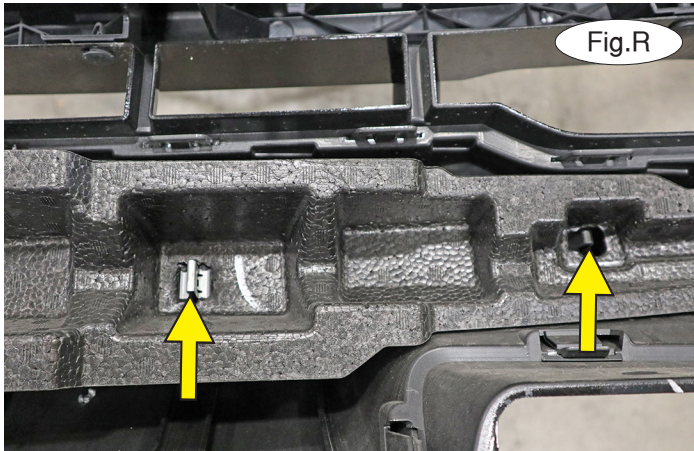

16. Reinstall the air dam by reversing step 10.

17. Permanently remove the shock absorption pad by releasing two clips on each side (Fig.R – Colorado models, Fig.S – Canyon models).

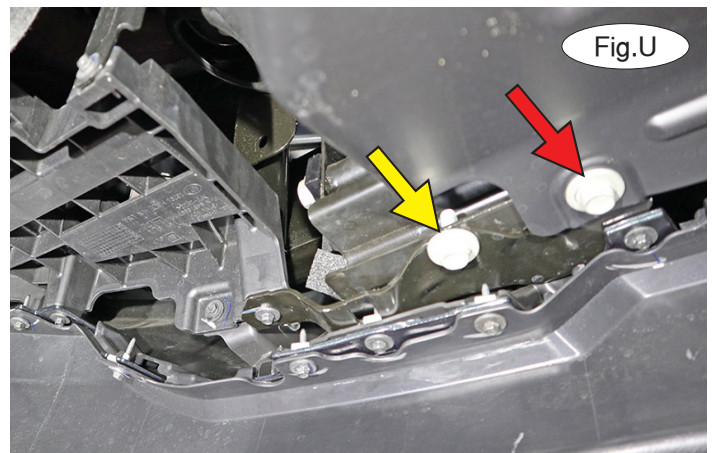
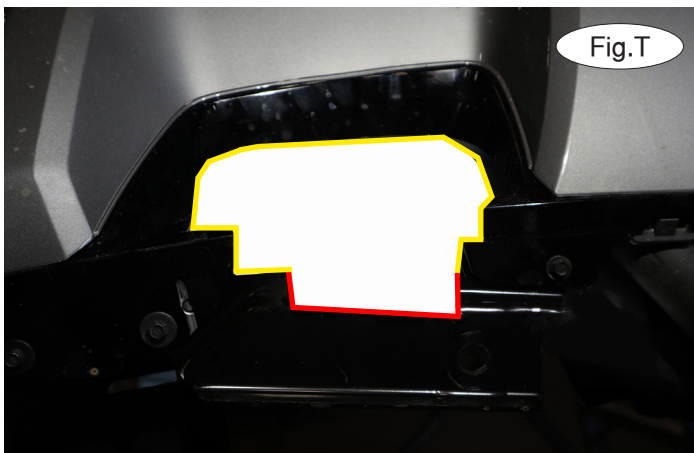

18. On each side, mark the tow hook opening and trim it (Fig.T – yellow lines). Then, test fit the fascia and trim any additional material as needed to allow clearance for the side-specific braces. *Note:* Due to manufacturing variances, you may also need to trim some of the lower metal section to allow for clearance (Fig.T – red lines).

19. Reinstall the fascia by reversing steps 1 through 7. *Note:* If you are using the supplied wiring plug bracket, you will need to remove the 15mm bolt indicated in Figure U – red arrow. The bolt indicated with the yellow arrow was already removed in a previous step.

20. On each side, remove six 7mm screws and one in the center attaching the lower air dam to the fascia (Fig.V). Pull toward the rear of the vehicle to loosen the locating clips and remove the lower air dam completely.

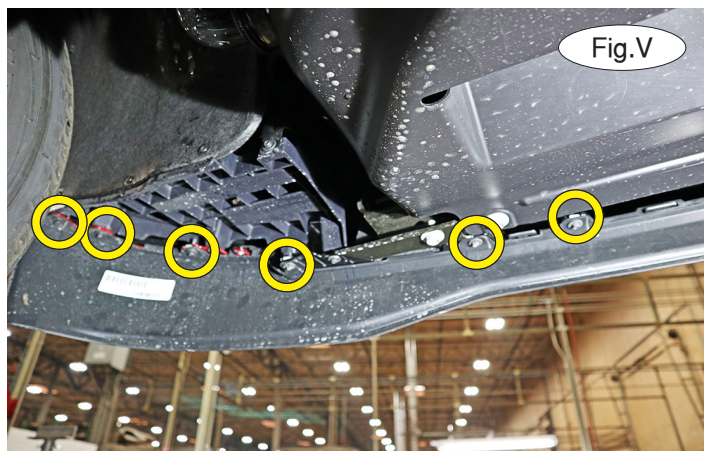



BASEPLATE KIT INSTALLATION INSTRUCTIONS

KIT# 523219-4

03/08/23
KS

ROADMASTER, Inc. 6110 NE 127th Ave. Vancouver, WA 98682 360-896-0407 fax 360-735-9300 www.roadmasterinc.com

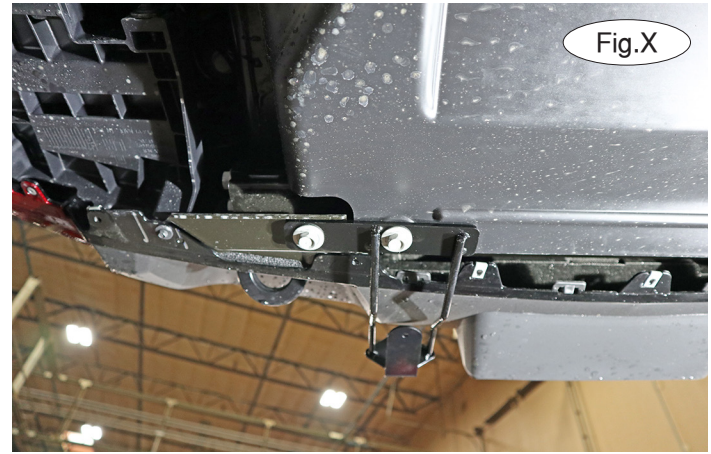
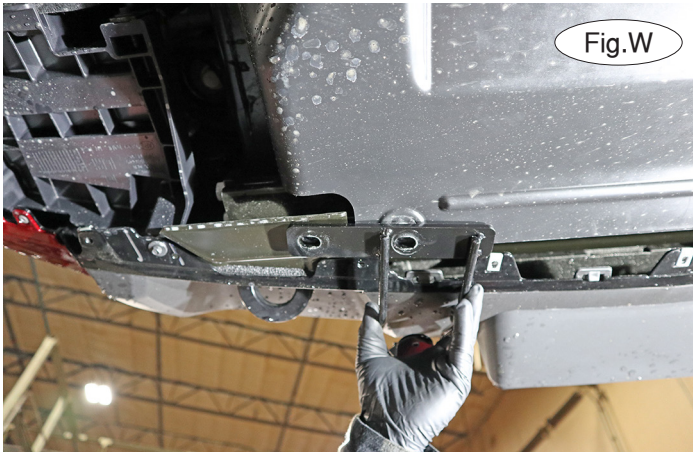

21. Place the wiring and Brakeaway combo bracket over the holes for the 15mm bolts (Fig.W) and replace the bolts and tighten (Fig.X). Hold the air dam in place over the bracket and mark it for trimming. Trim the lower air dam as shown and reinstall it (Fig.Y).



22. On each side, insert the removable front arm into the front receiver 90 degrees from its final towing position, depressing the spring-loaded pin against the receiver. Twist back 90 degrees until the spring-loaded pin snaps into place in the notch on the receiver, locking the arm into place in its final towing position.

Please note: It is the owner's responsibility to ensure the locking of the pins before towing. Otherwise, failure of the towing system will result.

23. Install the tow bar to the baseplate, according to the manufacturer's instructions.

IMPORTANT!

Safety cables are required by law. When towing, connect safety cables to the safety cable tabs illustrated on the first page and in Figure Z. Make certain there is adequate slack in the cables to allow a full turning radius; otherwise, damage will result. If necessary, longer cables or cable extensions are available.



BASEPLATE KIT INSTALLATION INSTRUCTIONS

KIT# 523219-4

03/08/23
KS

ROADMASTER, Inc. 6110 NE 127th Ave. Vancouver, WA 98682 360-896-0407 fax 360-735-9300 www.roadmasterinc.com

Three options for attaching the wiring plug to the main receiver brace

For six-wire plugs: use the two supplied $\frac{3}{4}$ " self-tapping screws to attach the electrical plug directly to the rods on the front of the main receiver brace.

For four-wire round plugs: attach to the plug mounting plate and then use the two supplied $\frac{3}{4}$ " self-tapping screws to attach the mounting plate to the rods on the front of the main receiver brace.

For four-wire flat plugs: place the plug through the mounting plug plate, and then secure it using the supplied zip tie on the front of the plug (Fig.AA). Use the two supplied $\frac{3}{4}$ " self-tapping screws to attach the mounting plate to the rods on the front of the main receiver brace.

