



# BASEPLATE KIT INSTALLATION INSTRUCTIONS

**KIT# 523226-5**

03/29/24  
KS

ROADMASTER, Inc. 6110 NE 127th Ave. Vancouver, WA 98682 360-896-0407 fax 360-735-9300 www.roadmasterinc.com

## Recommended Tools

Ratchets  
7mm, 13mm, 15mm sockets  
10mm wrench  
9/16" and 3/4" wrenches  
and sockets

T15 driver  
13/32" bit and drill  
Needlenose pliers  
Permanent marker

Panel tool  
Flathead screwdriver  
Utility knife or reciprocating saw  
Torque wrench  
Threadlocker

*Important  
Note: This baseplate will not accom-  
modate the Guardian rock shield, some  
models of the Tow Defender, or the  
StowMaster All Terrain tow bar.*

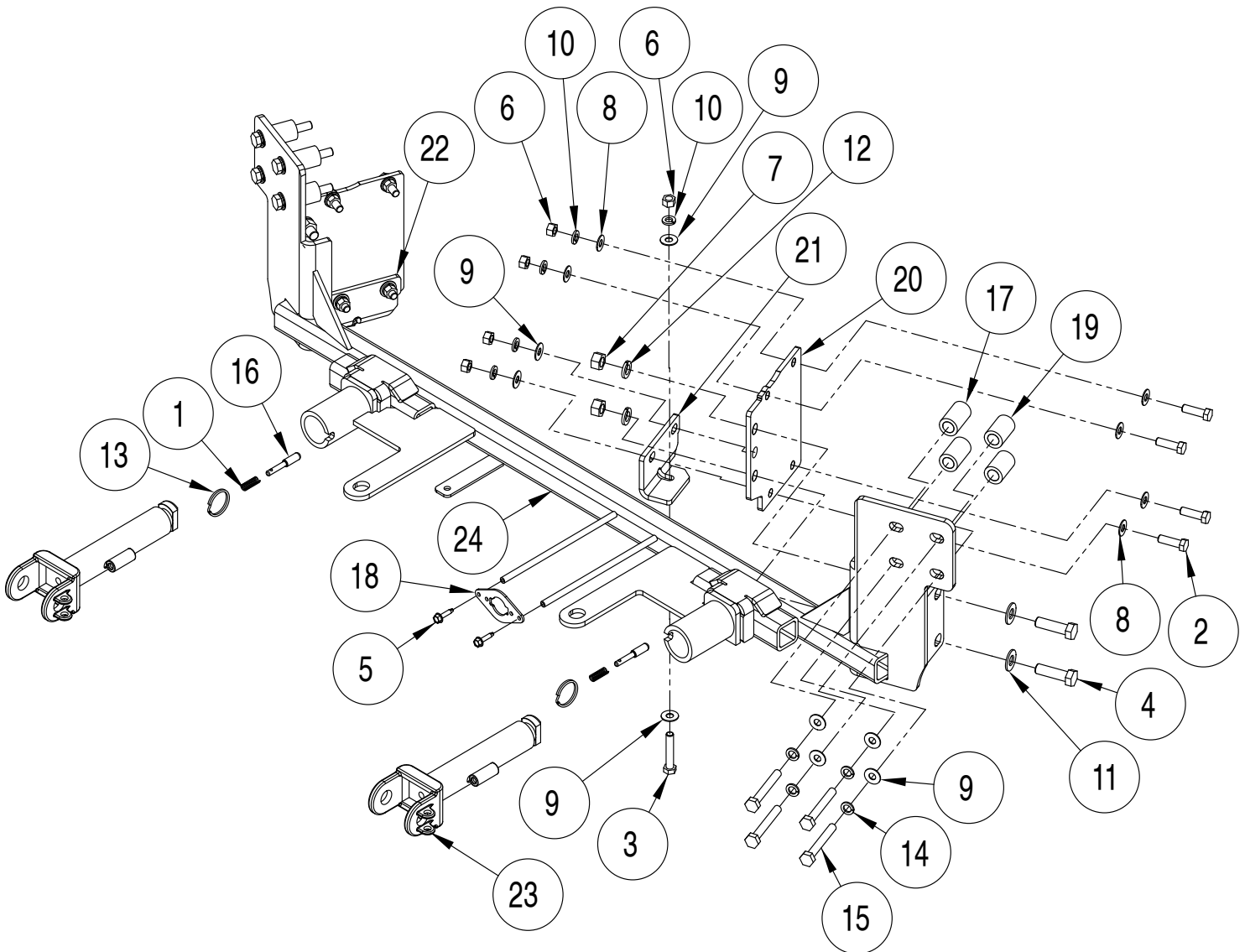

continued on next page



# BASEPLATE KIT INSTALLATION INSTRUCTIONS

**KIT# 523226-5**

03/29/24  
KS

ROADMASTER, Inc. 6110 NE 127th Ave. Vancouver, WA 98682 360-896-0407 fax 360-735-9300 www.roadmasterinc.com

## HARDWARE LIST

| ITEM    | QTY      | DESCRIPTION                          | PART NUMBER |
|---------|----------|--------------------------------------|-------------|
| 1.....  | 2 .....  | SPRING.....                          | 200146-00   |
| 2.....  | 8 .....  | 3/8" x 1 1/4" BOLT .....             | 350056-00   |
| 3.....  | 2 .....  | 3/8" x 2" BOLT .....                 | 350059-00   |
| 4.....  | 4 .....  | 1/2" x 1 3/4" BOLT .....             | 350096-00   |
| 5.....  | 2 .....  | #10 x 3/4" SELF DRILLING SCREW ..... | 350247-35   |
| 6.....  | 10 ..... | 3/8" HEX NUT .....                   | 350254-00   |
| 7.....  | 4 .....  | 1/2" HEX NUT .....                   | 350258-00   |
| 8.....  | 12 ..... | 3/8" SAE WASHER .....                | 350304-50   |
| 9.....  | 16 ..... | 3/8" FLAT WASHER.....                | 350304-00   |
| 10..... | 10 ..... | 3/8" LOCK WASHER.....                | 350305-00   |
| 11..... | 4 .....  | 1/2" SAE WASHER .....                | 350308-20   |
| 12..... | 4 .....  | 1/2" LOCK WASHER.....                | 350309-00   |
| 13..... | 2 .....  | RING .....                           | 350520-00   |
| 14..... | 8 .....  | M10 LOCK WASHER .....                | 355715-00   |
| 15..... | 8 .....  | M10 x 1.5 x 75 mm BOLT .....         | 356114-00   |
| 16..... | 2 .....  | LOCK PIN.....                        | A000008     |
| 17..... | 4 .....  | 1" O.D. x 1 5/8" SPACER.....         | A001442     |
| 18..... | 1 .....  | WIRE PLUG PLATE .....                | A003801     |
| 19..... | 4 .....  | 1" O.D. x 1 1/2" SPACER.....         | A002898     |
| 20..... | 2 .....  | PLATE .....                          | A006423     |
| 21..... | 1 .....  | DRIVER SIDE BRACE .....              | B003969     |
| 22..... | 1 .....  | PASSENGER SIDE BRACE.....            | B003970     |
| 23..... | 2 .....  | ARM .....                            | C002383     |
| 24..... | 1 .....  | MAIN RECEIVER .....                  | C003792     |



# BASEPLATE KIT INSTALLATION INSTRUCTIONS

**KIT# 523226-5**

03/29/24  
KS

ROADMASTER, Inc. 6110 NE 127th Ave. Vancouver, WA 98682 360-896-0407 fax 360-735-9300 www.roadmasterinc.com

This is one of our direct-connect baseplates, which allows the visible front portion of the baseplate to be easily removed from the front of the vehicle (Fig.A and Fig.B).

The kit mounts to the frame of the vehicle, and consists of two side-specific braces, a main receiver brace, two lower braces, two removable front braces, and a hardware pack.

Before starting the installation, lay out the kit components in order, as they will be used. This will give you a visual idea of how the components work, and will also confirm that everything is present and accounted for.



**IMPORTANT:** All baseplates **must** be assembled with all the bolts left loose for final adjustment and positioning (before tightening) unless otherwise instructed. All bolts **must** be torqued for proper strength. If more than one bolt is used per fastening point, the diagram may only show one. Use flat washers over all slotted holes and lock washers on all fasteners.

## WARNING

Failure to heed these warnings or follow the installation instructions may result in a voided warranty, loss of towed vehicle, personal injury or death.

- Do not weld or modify this baseplate or its components. Welding or modification will void the warranty.
- Do not use this document as a basis to design/fabricate a baseplate, as it may not show all parts or structural components.
- We strongly recommend professional installation.
- If the towed vehicle has been in an accident, it must be properly repaired before attaching the baseplate. Do not install the baseplate if any structural frame damage is found.
- The installer must use all bolts and parts supplied. If running changes were made by the vehicle manufacturer after this kit was designed, some bolts or other fasteners may no longer be the correct size. It is the installer's responsibility to verify this kit is securely fastened to the vehicle.
- Use Loctite® Red on all bolts used to secure this baseplate. Torque all bolts to the specifications found at the end of these instructions. Do not over-torque the bolts or failure may occur.
- The installer must inspect the baseplate to ensure adequate clearance, particularly around hoses, air conditioner lines, radiators, etc. or non-warranty failure may result.
- Roadmaster manufactures many styles of baseplates. If your baseplate has removable arms, they must be removed before driving the vehicle, unless the arms can be pinned or padlocked in place. If not secured, the arms could vibrate out.
- Some motorhome chassis have such a tight turning radius that you can damage your motorhome, towed vehicle, tow bar or baseplate while turning sharply. Before getting on the road, test your turning radius in an empty parking lot. Turning too sharply could result in non-warranty damage to your towing system, motorhome and/or towed vehicle.
- Do not back up with the towed vehicle attached or non-warranty damage will occur to your towing system or vehicles.
- The safety cables must connect the towing vehicle to the towed vehicle frame to frame, with the cables crossed, with enough slack for sharp turns. See cable instructions for proper routing. Failure to do so will result in non-warranty damage and/or the loss of the towed vehicle.
- This kit is designed for use with ROADMASTER tow bars and ROADMASTER adapters only. Using this kit with other brands, without an approved ROADMASTER adapter, may result in non-warranty damage or injury.
- Receiver extensions and out-of-level towing situations of 3 inches or more. This can cause the system to swing much higher and lower, causing excessive strain on the tow bar, baseplate and frame. That can cause the towing system to fail, causing property damage, personal injury or even death. If you must use a receiver extension or drop hitch to tow, it will reduce your receiver's weight capacity by 1/3 to avoid damaging your system. Never use more than one extension and/or drop hitch, as this will void your warranty.
- Every 3,000 miles, the owner must inspect all mounting points for cracks or fatigue, and check the fasteners for proper torque, according to the bolt torque requirements chart on the last page of these instructions.
- The owner must follow the vehicle manufacturer's instructions to prepare the vehicle for towing. Failure to do so may cause severe damage to the vehicle.
- This baseplate is only warranted for the original installation. Installing a used baseplate on another vehicle is not recommended and will void the warranty.



# BASEPLATE KIT INSTALLATION INSTRUCTIONS

**KIT# 523226-5**

03/29/24  
KS

ROADMASTER, Inc. 6110 NE 127th Ave. Vancouver, WA 98682 360-896-0407 fax 360-735-9300 www.roadmasterinc.com

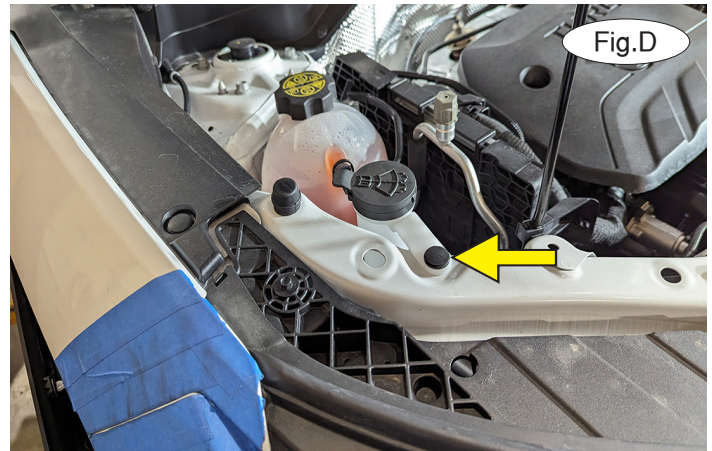
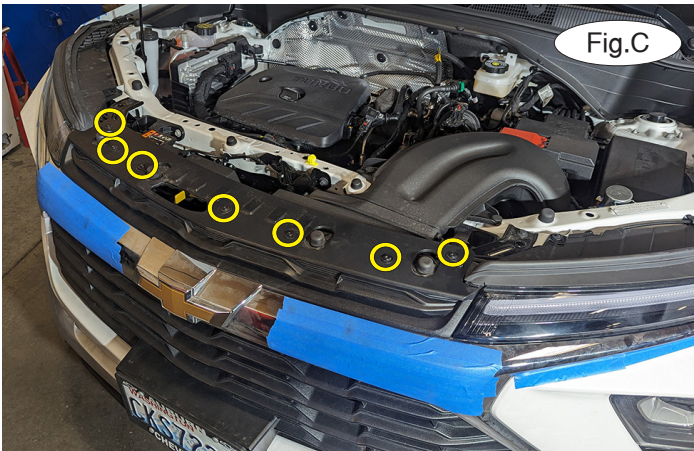

**Important: Please use all supplied bolts and parts and read all instructions carefully before beginning this installation. The majority of questions you may have can be answered within the text, and proper installation will ensure safe and secure travel.**

1. Remove seven T15 screws attaching the top of the fascia to the core support (Fig.C).
2. On the passenger side, use a panel tool to remove one plastic fastener attaching the filler neck of the washer bottle to the core support (Fig.D). Twist while pulling up to remove it, and set it aside for now.



3. On each side, remove eight T15 screws (Fig.E – circles) and two 7mm screws (arrows) attaching the bottom of the fascia to the subframe.
4. On each side, turn the tire inward and remove four T15 screws (circles) and one plastic clip (arrow) attaching the fender liner to the fascia (Fig.F).
5. On each side, pull down on the fender liner and release the clips on the fender trim until you can access a 7mm screw (Fig.G). Remove the screw. *Note: It may be helpful to reach behind the fender and squeeze the clips with a pair of needlenose pliers.*

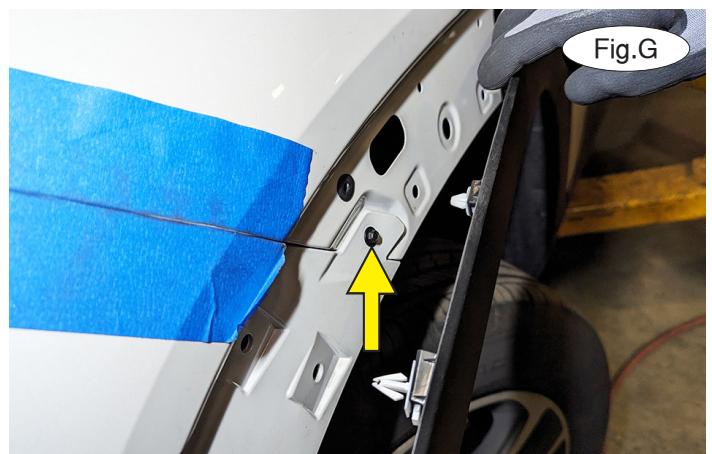



# BASEPLATE KIT INSTALLATION INSTRUCTIONS

**KIT# 523226-5**

03/29/24  
KS

ROADMASTER, Inc. 6110 NE 127th Ave. Vancouver, WA 98682 360-896-0407 fax 360-735-9300 www.roadmasterinc.com



6. On each side, lift up on the top of the fascia (Fig.H) and then release the fascia along the fender seam (Fig.I). Unplug any remaining wiring harnesses, and set it aside for now.

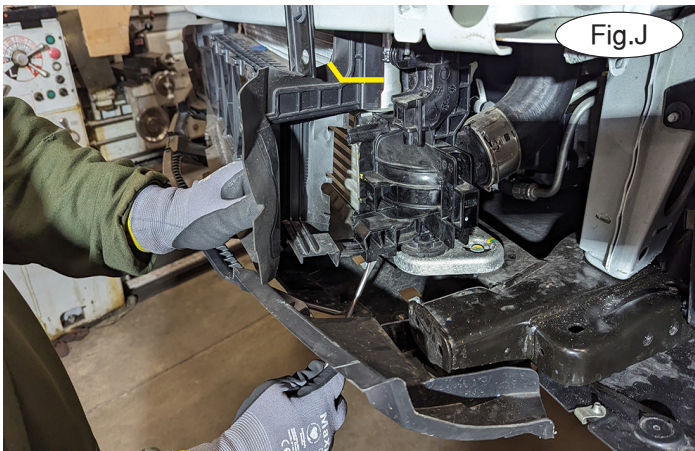

7. On each side, use a utility knife or reciprocating saw to separate the lower air dam (Figure J, yellow lines). Then, use a flathead screwdriver or panel tool to release the clip and pull straight out to remove it. It will not be replaced.

8. On each side, carefully trim the upper intercooler end cap as indicated with yellow lines in Figure K.

9. On the driver's side only, remove two 10mm nuts attaching the computer box to the frame (Fig.L). Then, use a flat-head screwdriver to pop out the plastic clip (Fig.M).

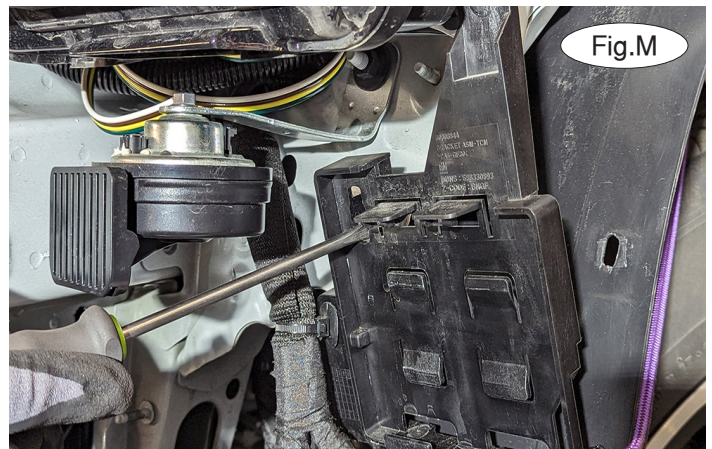
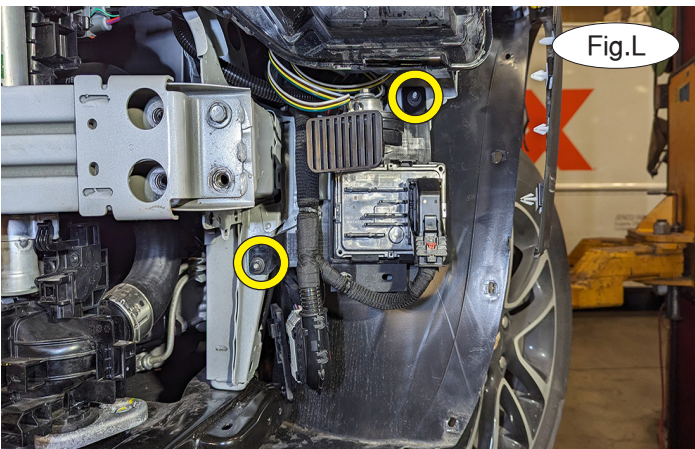



# BASEPLATE KIT INSTALLATION INSTRUCTIONS

**KIT# 523226-5**

03/29/24  
KS

ROADMASTER, Inc. 6110 NE 127th Ave. Vancouver, WA 98682 360-896-0407 fax 360-735-9300 www.roadmasterinc.com

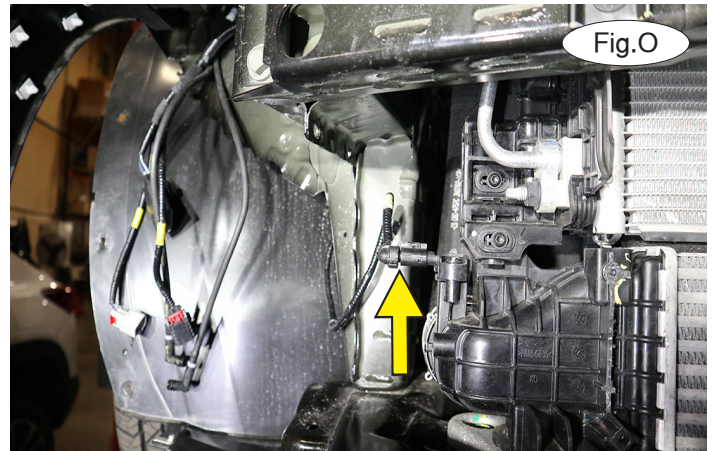
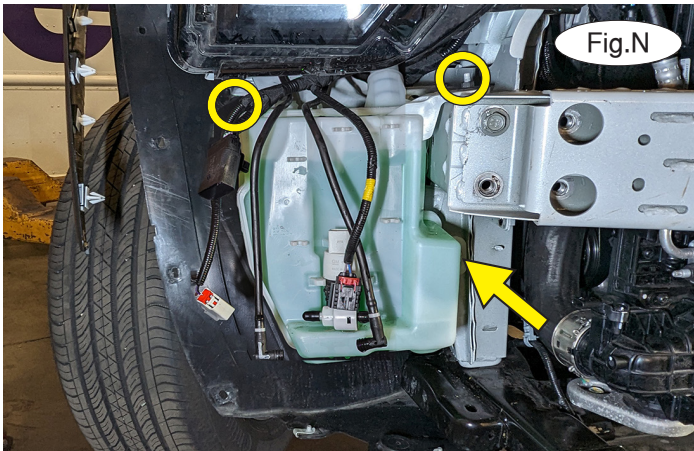

10. Now, working on the passenger side, disconnect all of the wiring harnesses and fluid lines for the washer bottle. *Note: When disconnecting the fluid lines, be prepared to cap the outlet lines to eliminate fluid loss.* Now, remove two 10mm nuts (Fig.N – circles) and one 10mm bolt (arrow) attaching the washer bottle to the frame and carefully set it aside for now.

11. On the passenger side only, disconnect the air flow sensor for the intercooler and let it hang down for now (Fig.O).

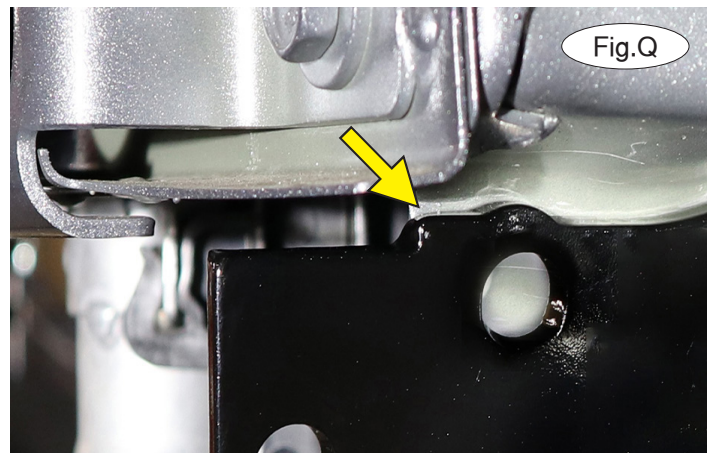

12. Starting on the driver's side, use the drawing on page 1 to locate the side-specific main receiver brace. Hold it in place as shown in Figure P and use a Sharpie or paint marker to mark the two upper mounting holes in the pinch weld for drilling. *Note: The raised edge of the plate should align with the forward edge of the pinch weld (Fig.Q).*

13. Use a 13/32" drill bit to drill out the two holes you marked in the previous step (Fig.R).

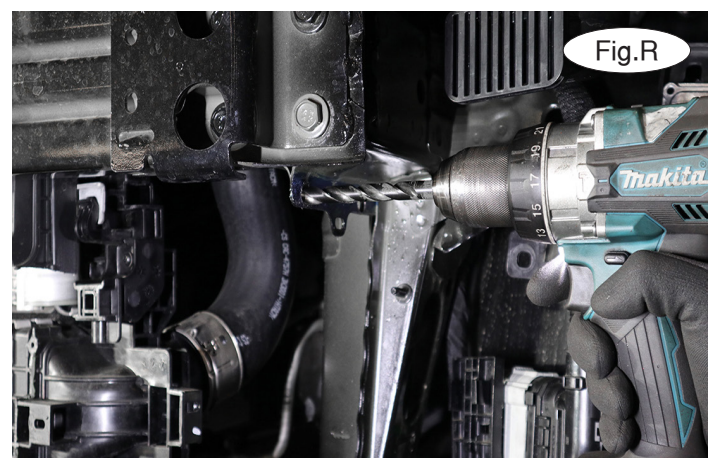



# BASEPLATE KIT INSTALLATION INSTRUCTIONS

**KIT# 523226-5**

03/29/24  
KS

ROADMASTER, Inc. 6110 NE 127th Ave. Vancouver, WA 98682 360-896-0407 fax 360-735-9300 www.roadmasterinc.com

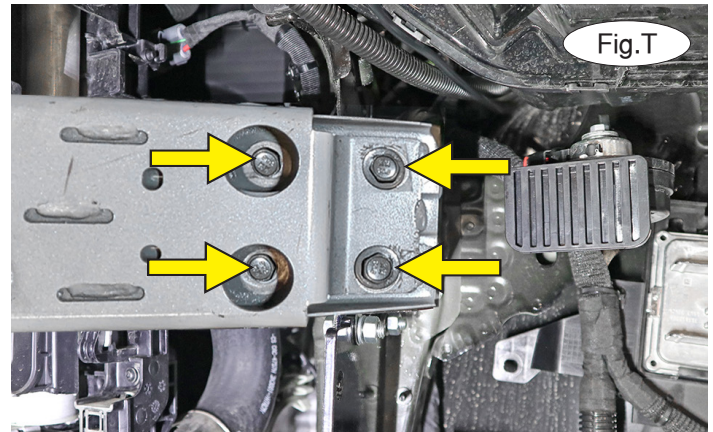
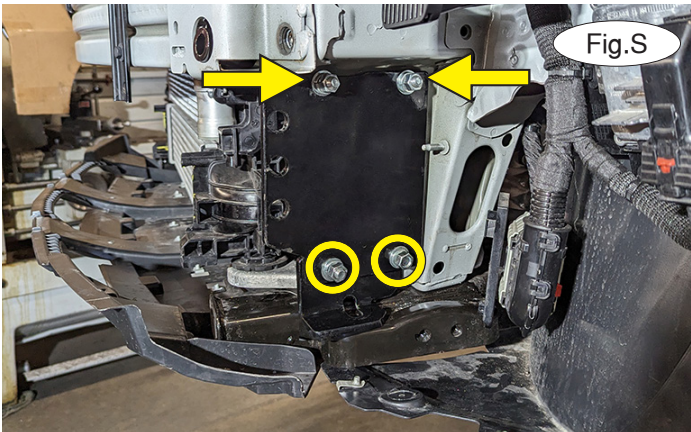

14. Working on the driver's side only, use the drawing on page 1 to locate the side-specific lower and upper braces. Place two of the supplied  $3/8"$  x  $1/4"$  bolts through the upper side-specific plate and pinch weld holes you drilled in the previous step. Finish the bolts with  $3/8"$  lock washers,  $3/8"$  small flat washers and  $3/8"$  nuts (Fig.S – arrows).

Now, place two  $3/8"$  x  $1/4"$  bolts through the lower brace to the upper brace. Finish with  $3/8"$  flat washers, lock washers and nuts (Fig.S – circles). *Note: Leave everything finger tight for now.*

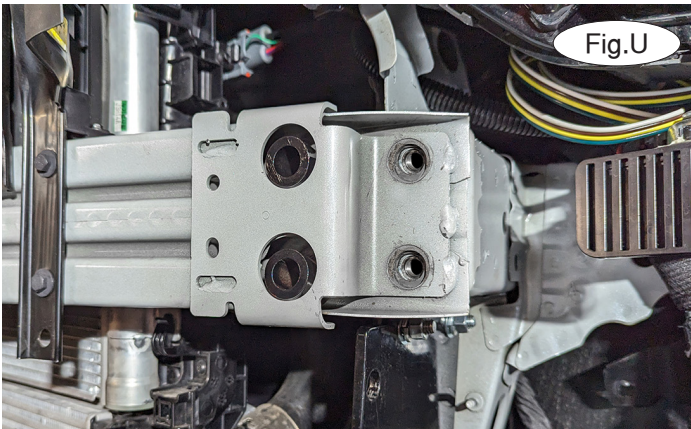

15. Remove the four 15mm bolts attaching the bumper core to the frame (Fig.T).

16. Insert two of the 1" O.D. x .188 wall x 1-5/8" spacers over the innermost holes you exposed in the previous step (Fig.U).

17. Place M10 lock washers and  $3/8"$  flat washers over four M10 x 1.5 x 75mm bolts. With the assistance of a second person, lift the baseplate over the bumper core and pass the M10 bolts through the baseplate and the pipe spacers you installed in the previous step. Thread the bolts in just enough to hold the baseplate in place.

Now, on the two outermost holes on each side, place a 1" O.D. x .188 wall x  $1/2"$  pipe spacer between the bumper core and the baseplate. Then, bolt through the baseplate, the pipe spacer and into the bumper core mounts using the two remaining M10 bolts, M10 lock washers and  $3/8"$  flat washers (Fig.V).

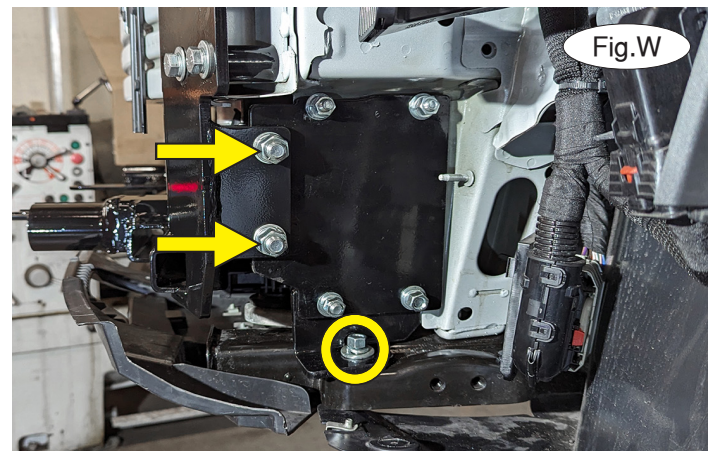

18. Bolt the upper brace to the main receiver using the supplied  $1/2"$  x  $1 3/4"$  bolts and  $1/2"$  SAE washers and finish with  $1/2"$  lock washers and  $1/2"$  nuts (Fig.W – arrows). Place a  $3/8"$  flat washer and threadlocker over a  $3/8"$  x 2" bolt and bolt up through the existing hole in the bottom of the subframe, through the lower mount, and finish with a  $3/8"$  flat washer,  $3/8"$  lock washer and  $3/8"$  nut (Fig.W – circle).



# BASEPLATE KIT INSTALLATION INSTRUCTIONS

**KIT# 523226-5**

03/29/24  
KS

ROADMASTER, Inc. 6110 NE 127th Ave. Vancouver, WA 98682 360-896-0407 fax 360-735-9300 www.roadmasterinc.com

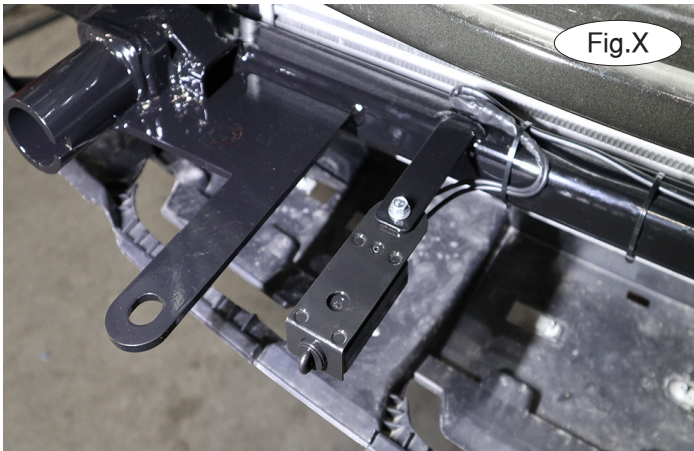

Fig.X



Fig.Y

19. Repeat steps 14-18 for the passenger side. Then, tighten all bolts to the torque requirements found at the end of these instructions. **Note: Use threadlocker on all nuts and bolts.**

20. If you are using our Brakeaway switch, use the included mount as shown in Figure X.

21. Trim the foam shock absorption pad as shown in Figure Y.



Fig.Z

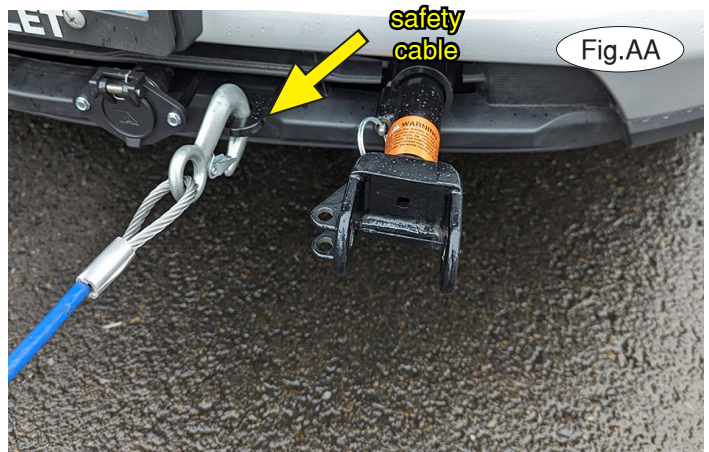

Fig.AA

22. Hold the fascia up to the vehicle and mark it for trimming to allow clearance for the receivers, safety cable tabs and the Brakeaway mount, if applicable (Fig.Z). Reinstall the fascia, reversing steps 1 through 6.

23. Re-connect the computer on the driver's side by reversing step 9.

24. Re-connect the washer bottle and the air flow sensor by reversing steps 10 and 11.

## **IMPORTANT!**

**Safety cables are required by law. When towing, connect safety cables to the safety cable tabs illustrated on the first page and in Figure AA. Make certain there is adequate slack in the cables to allow a full turning radius; otherwise, damage will result. If necessary, longer cables or cable extensions are available.**



# BASEPLATE KIT INSTALLATION INSTRUCTIONS

**KIT# 523226-5**

03/29/24  
KS

ROADMASTER, Inc. 6110 NE 127th Ave. Vancouver, WA 98682 360-896-0407 fax 360-735-9300 www.roadmasterinc.com

## Three options for attaching the wiring plug to the main receiver brace

**For six-wire plugs:** Use the two supplied 3/4" self-tapping screws to attach the electrical plug directly to the rods on the front of the main receiver brace.

**For four-wire round plugs:** Attach to the plug mounting plate and then use the two supplied 3/4" self-tapping screws to attach the mounting plate to the rods on the front of the main receiver brace.

**For four-wire flat plugs:** Place the plug through the mounting plug plate, and then secure it using the supplied zip tie on the front of the plug (Fig.BB). Use the two supplied 3/4" self-tapping screws to attach the mounting plate to the rods on the front of the main receiver brace.

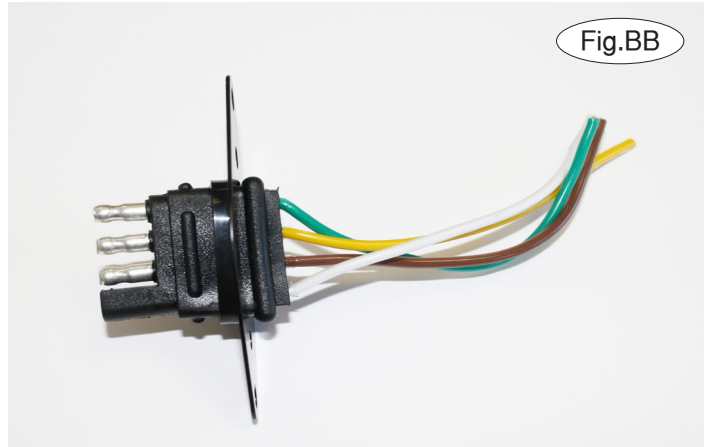

### BOLT TORQUE REQUIREMENTS

Note: The torque values represented below are intended as general guidelines. Torque requirements for specific applications may vary. Roadmaster does not warrant this information to be accurate for all applications and disclaims all liability for any claims or damages which may result from its use.

#### STANDARD BOLTS

| Thread Size | Grade | Torque      |
|-------------|-------|-------------|
| 5/16-18     | 5     | 13 ft./lb.  |
| 3/8-16      | 5     | 23 ft./lb.  |
| 7/16-14     | 5     | 37 ft./lb.  |
| 1/2-13      | 5     | 57 ft./lb.  |
| 5/8-11      | 5     | 112 ft./lb. |

#### METRIC BOLTS

| Thread Size | Grade | Torque     |
|-------------|-------|------------|
| 6mm-1.0     | 8.8   | 6 ft./lb.  |
| 8mm-1.0     | 8.8   | 18 ft./lb. |
| 8mm-1.25    | 8.8   | 16 ft./lb. |
| 10mm-1.25   | 8.8   | 36 ft./lb. |
| 10mm-1.5    | 8.8   | 31 ft./lb. |

#### METRIC BOLTS

| Thread Size | Grade | Torque     |
|-------------|-------|------------|
| 12mm-1.25   | 8.8   | 64 ft./lb. |
| 12mm-1.5    | 8.8   | 60 ft./lb. |
| 12mm-1.75   | 8.8   | 55 ft./lb. |
| 14mm-2.0    | 8.8   | 88 ft./lb. |

All illustrations and specifications contained herein are based on the latest information available at the time of publication approval. ROADMASTER, INC. reserves the right to make changes at any time without notice in material, specification and models or to discontinue models.