



# BASEPLATE KIT INSTALLATION INSTRUCTIONS

**KIT# 524434-4**

08/09/13  
KS

ROADMASTER, Inc. 6110 NE 127th Ave. Vancouver, WA 98682 360-896-0407 fax 360-735-9300 www.roadmasterinc.com

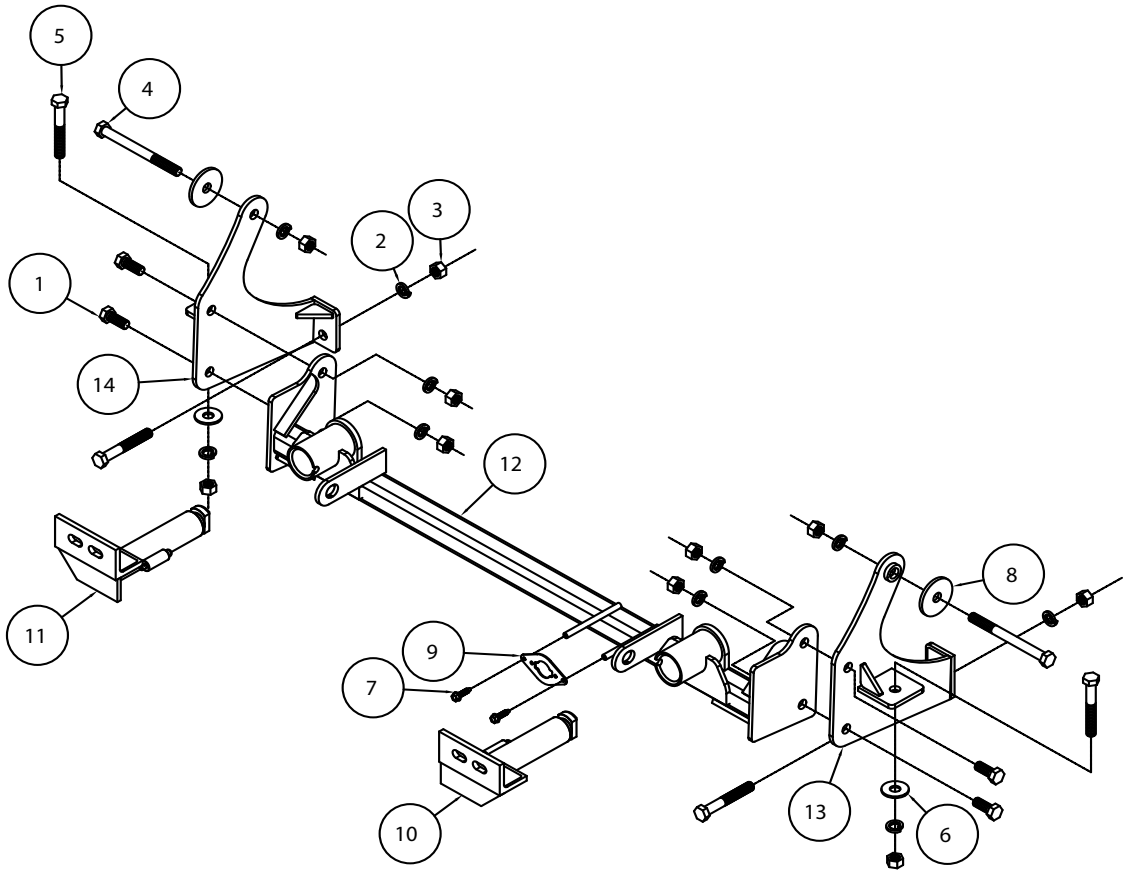

ITEM	QTY	NAME	PART #
1.....4.....	4	1/2" x 1 1/4" BOLT .....	350094-00
2.....10.....	10	1/2" LOCK WASHER.....	350309-00
3.....10.....	10	1/2" HEX NUT.....	350258-00
4.....2.....	2	1/2" x 5 1/2" BOLT .....	350108-00
5.....4.....	4	1/2" x 3 1/2" BOLT .....	350103-00
6.....2.....	2	1/2" FLAT WASHER .....	350308-00
7.....2.....	2	SELF TAPPING SCREW .....	350247-35
8.....2.....	2	1/2" PLATE WASHER .....	A-003086
9.....1.....	1	WIRE MOUNTING PLATE .....	A-003801
10.....1.....	1	DRIVER SIDE ARM .....	C-002540
11.....1.....	1	PASSENGER SIDE ARM.....	C-002541
12.....1.....	1	MAIN RECEIVER .....	C-002542
13.....1.....	1	DRIVER SIDE BRACE .....	C-002543
14.....1.....	1	PASSENGER SIDE BRACE .....	C-002544



# BASEPLATE KIT INSTALLATION INSTRUCTIONS

**KIT# 524434-4**

08/09/13  
KS

ROADMASTER, Inc. 6110 NE 127th Ave. Vancouver, WA 98682 360-896-0407 fax 360-735-9300 www.roadmasterinc.com

This is one of our EZ4 Twistlock series brackets, which allows the visible front portion of the bracket to be easily removed from the front of the vehicle (Fig.A and Fig.B). The bracket consists of a main receiver brace, two removable front braces, two rear support bracket and a hardware pack.

The main receiver brace mounts to the sub-frame, bumper core and rear support plates. The removable front braces install in the main receiver brace.

Before starting the installation, lay out the kit components in order, as they will be used. This will give you a visual idea of how the components work, and will also confirm that everything is present and accounted for.

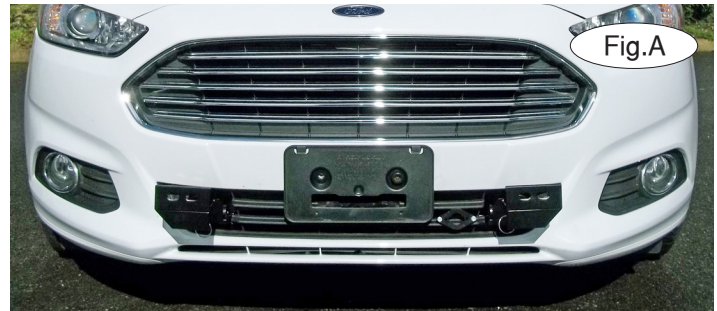

**IMPORTANT:** All baseplates **must** be assembled with all the bolts left loose for final adjustment and positioning (before tightening) unless otherwise instructed. All bolts **must** be torqued for proper strength. If more than one bolt is used per fastening point, the diagram may only show one. Use flat washers over all slotted holes and lock washers on all fasteners.

## WARNING

Failure to heed these warnings or follow the installation instructions may result in a voided warranty, loss of towed vehicle, personal injury or death.

- Do not weld or modify this baseplate or its components. Welding or modification will void the warranty.
- Do not use this document as a basis to design/fabricate a baseplate, as it may not show all parts or structural components.
- We strongly recommend professional installation.
- If the towed vehicle has been in an accident, it must be properly repaired before attaching the baseplate. Do not install the baseplate if any structural frame damage is found.
- The installer must use all bolts and parts supplied. If running changes were made by the vehicle manufacturer after this kit was designed, some bolts or other fasteners may no longer be the correct size. It is the installer's responsibility to verify this kit is securely fastened to the vehicle.
- Use Loctite® Red on all bolts used to secure this baseplate. Torque all bolts to the specifications found at the end of these instructions. Do not over-torque the bolts or failure may occur.
- The installer must inspect the baseplate to ensure adequate clearance, particularly around hoses, air conditioner lines, radiators, etc. or non-warranty failure may result.
- Roadmaster manufactures many styles of baseplates. If your baseplate has removable arms, they must be removed before driving the vehicle, unless the arms can be pinned or padlocked in place. If not secured, the arms could vibrate out.
- Some motorhome chassis have such a tight turning radius that you can damage your motorhome, towed vehicle, tow bar or baseplate while turning sharply. Before getting on the road, test your turning radius in an empty parking lot. Turning too sharply could result in non-warranty damage to your towing system, motorhome and/or towed vehicle.
- Do not back up with the towed vehicle attached or non-warranty damage will occur to your towing system or vehicles.
- The safety cables must connect the towing vehicle to the towed vehicle frame to frame, with the cables crossed, with enough slack for sharp turns. See cable instructions for proper routing. Failure to do so will result in non-warranty damage and/or the loss of the towed vehicle.
- This kit is designed for use with ROADMASTER tow bars and ROADMASTER adapters only. Using this kit with other brands, without an approved ROADMASTER adapter, may result in non-warranty damage or injury.
- Receiver extensions and out-of-level towing situations of 3 inches or more. This can cause the system to swing much higher and lower, causing excessive strain on the tow bar, baseplate and frame. That can cause the towing system to fail, causing property damage, personal injury or even death. If you must use a receiver extension or drop hitch to tow, it will reduce your receiver's weight capacity by 1/3 to avoid damaging your system. Never use more than one extension and/or drop hitch, as this will void your warranty.
- Every 3,000 miles, the owner must inspect all mounting points for cracks or fatigue, and check the fasteners for proper torque, according to the bolt torque requirements chart on the last page of these instructions.
- The owner must follow the vehicle manufacturer's instructions to prepare the vehicle for towing. Failure to do so may cause severe damage to the vehicle.
- This baseplate is only warranted for the original installation. Installing a used baseplate on another vehicle is not recommended and will void the warranty.



# BASEPLATE KIT INSTALLATION INSTRUCTIONS

**KIT# 524434-4**

08/09/13  
KS

ROADMASTER, Inc. 6110 NE 127th Ave. Vancouver, WA 98682 360-896-0407 fax 360-735-9300 www.roadmasterinc.com

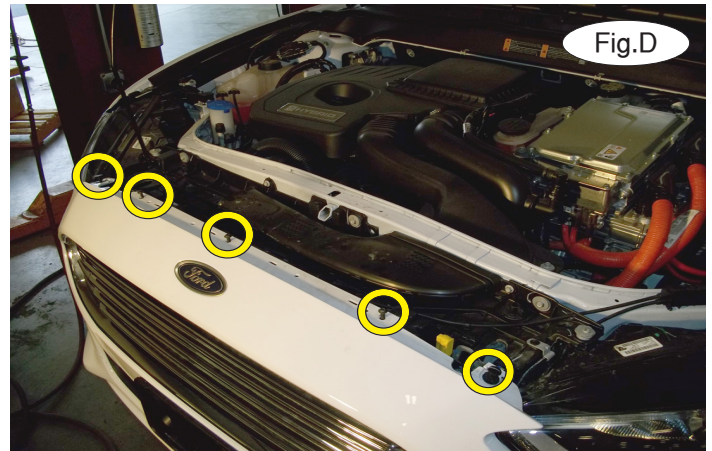
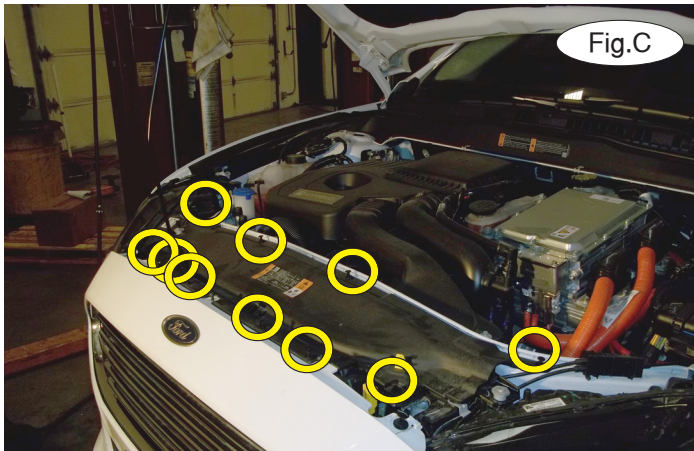

1. **Important:** please use all supplied bolts and parts and read all instructions carefully before beginning this installation. The majority of questions you may have can be answered within the text, and proper installation will ensure safe and secure travel. Now, begin the installation. Remove 10 plastic fasteners attaching the radiator cover to the core support (Fig.C).

2. Remove three T25 Torx screws and two plastic fasteners attaching the upper fascia to the core support (Fig.D).

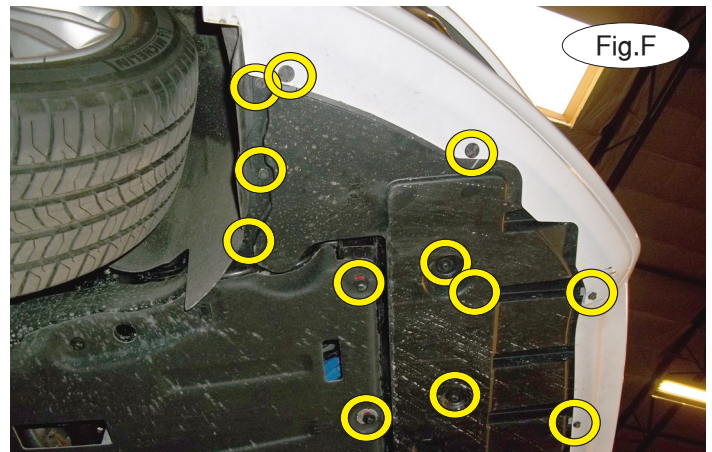
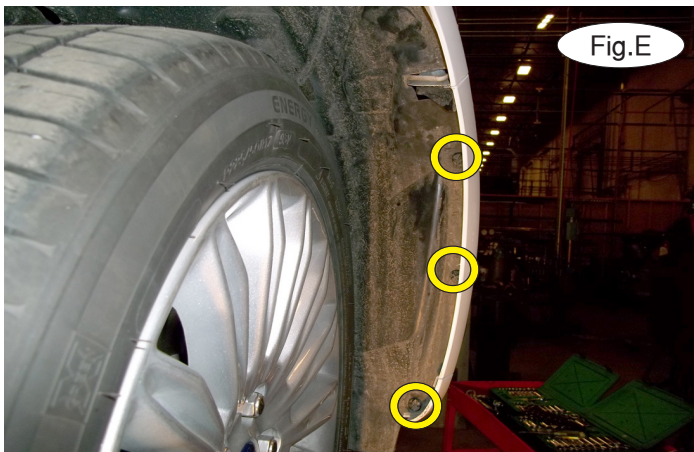

3. On each side, three plastic fasteners attaching the fender liner to the fascia (Fig.E).

4. Remove 11 10mm (head) screws, four plastic fasteners and eight T30 Torx attaching the splash shield to the fascia and core support. Use the yellow circles in Figure F (passenger side) to approximate the location of all fasteners on the driver's side and in the middle of the splash shield.

5. Remove 11 T30 Torx screws and release two plastic clips attaching the secondary splash shielding to the undercarriage (Fig.G).





# BASEPLATE KIT INSTALLATION INSTRUCTIONS

**KIT# 524434-4**

08/09/13  
KS

ROADMASTER, Inc. 6110 NE 127th Ave. Vancouver, WA 98682 360-896-0407 fax 360-735-9300 www.roadmasterinc.com

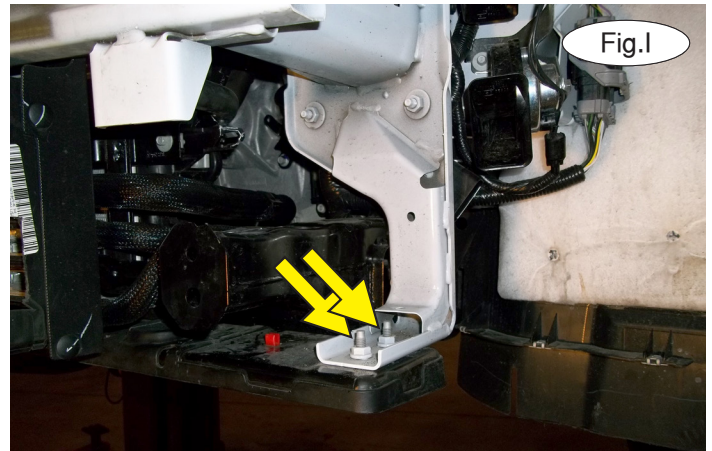

6. Pull out and forward carefully on each corner of the fascia to release it from the locking strip (Fig.H). Disconnect the fog lights, ambient temperature sensor and louvers, if the vehicle is so equipped.

7. On each side, remove two 10mm (head) bolts attaching the radiator support to the frame (Fig.I). Gently lower the radiator and let it hang down for now (Fig.J).

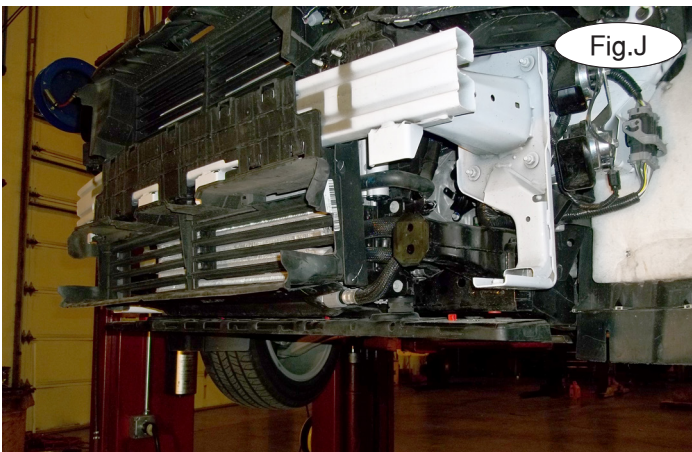

8. On each side, use a 1/2" drill to enlarge the pre-existing holes in the bottom and top of the sub frame (Fig.K).

9. On each side, mark a point for drilling that is centered on the side of the bumper core from top to bottom and 2" from the backside of the bumper core (Fig.L). Now, use a 1/2" drill to drill through the outside of the bumper core and through a pre-existing hole on the inside of the bumper core (Fig.M). If you experience difficulty in drilling due to the hard composition of the bumper core, drill a pilot hole first. Make certain you use a sharp drill bit. *Note:* use a piece of metal as a buffer between the drill bit and the engine components.

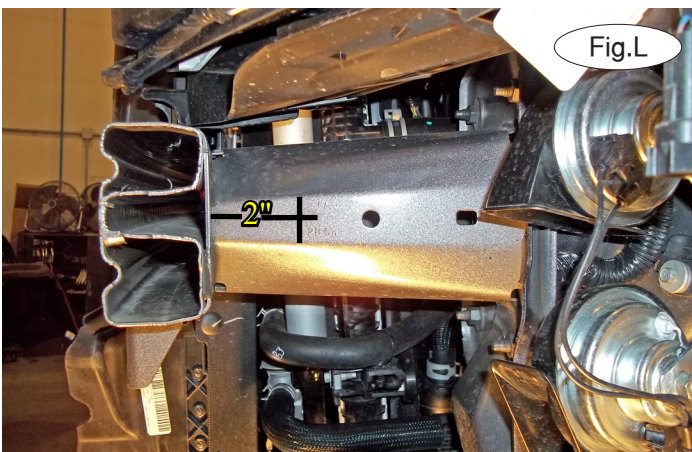



# BASEPLATE KIT INSTALLATION INSTRUCTIONS

**KIT# 524434-4**

08/09/13  
KS

ROADMASTER, Inc. 6110 NE 127th Ave. Vancouver, WA 98682 360-896-0407 fax 360-735-9300 www.roadmasterinc.com



Fig.N



Fig.O

10. On each side, place the rear support bracket over the top of the subframe (Fig.N), aligning it with the hole you just drilled in step 9 (Fig.O).

11. On each side, place one of the supplied  $\frac{1}{2}$ " plate washers over a  $\frac{1}{2}$ " x  $5\frac{1}{2}$ " bolt and bolt through the bumper core and rear support bracket and finish with a  $\frac{1}{2}$ " lock washer and nut (Fig.P). *Note:* ensure proper alignment, as the bolts will receive Loctite® Red and will be torqued at the end of these instructions.

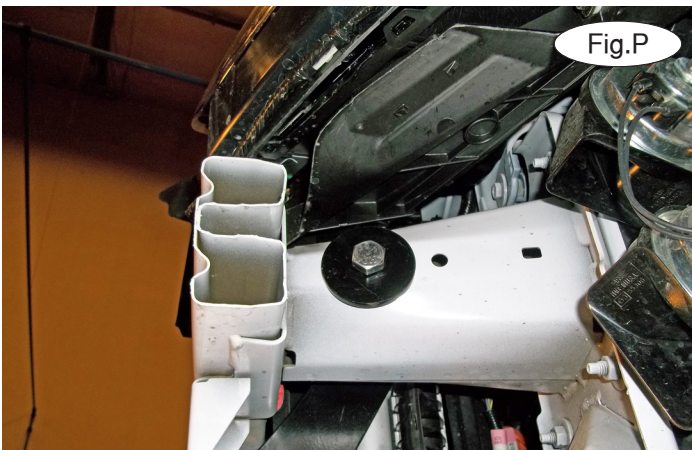

Fig.P

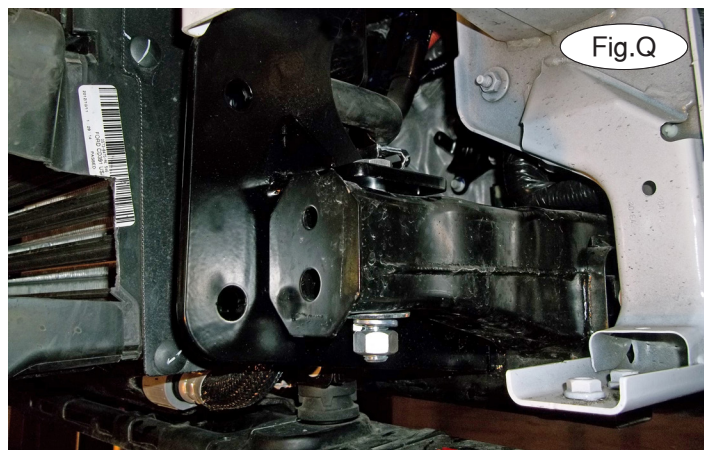

Fig.Q

12. On each side, using one of the supplied  $\frac{1}{2}$ " x  $3\frac{1}{2}$ " bolts, bolt down through the rear support plate and subframe and finish with a  $\frac{1}{2}$ " lock washer and nut (Fig.Q).

13. On each side, using one of the supplied  $\frac{1}{2}$ " x  $3\frac{1}{2}$ " bolts, bolt through the rear support plate and back of the subframe, and finish with a  $\frac{1}{2}$ " flat washer, lock washer and nut (Fig.R).



Fig.R



# BASEPLATE KIT INSTALLATION INSTRUCTIONS

**KIT# 524434-4**

08/09/13  
KS

ROADMASTER, Inc. 6110 NE 127th Ave. Vancouver, WA 98682 360-896-0407 fax 360-735-9300 www.roadmasterinc.com

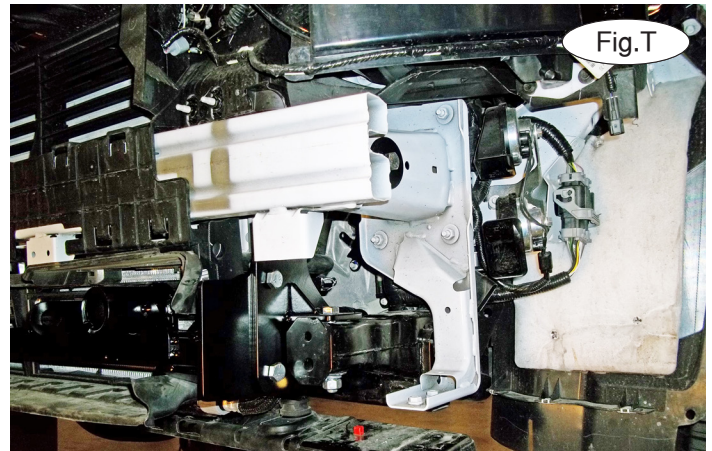
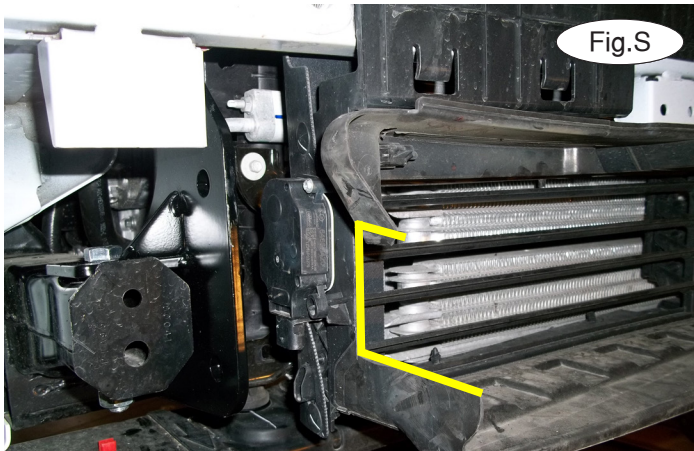

14. On each side, trim the louver shroud as shown in Figure S.

15. Place the main receiver brace between the two rear support plates and bolt it to the plates on each side using two of the supplied  $\frac{1}{2}$ " x  $1\frac{1}{4}$ " bolts, lock washers and nuts (Fig.T).



16. On each side, trim the fascia as shown in Figure U.

17. Ensure the main receiver brace is level, and then tighten all bolts to the bolt torque requirements found at the end of these instructions. *Note: use Loctite® Red on all nuts and bolts.*

18. Reinstall the fascia and radiator, reversing steps 1-7.

19. **Note: the following four images are for illustration purposes only, as your specific application may be slightly different.**

The spring-loaded pin on the removable arm snaps into a notch on the receiver, locking the removable arm into its final towing position. Before inserting each arm into the receiver, verify that the spring is working by ensuring that the spring-loaded pin moves easily back and forth within the barrel when pulled and that it can be pulled flush with the face of the barrel (Fig.V and Fig.W).





# BASEPLATE KIT INSTALLATION INSTRUCTIONS

**KIT# 524434-4**

08/09/13  
KS

ROADMASTER, Inc. 6110 NE 127th Ave. Vancouver, WA 98682 360-896-0407 fax 360-735-9300 www.roadmasterinc.com

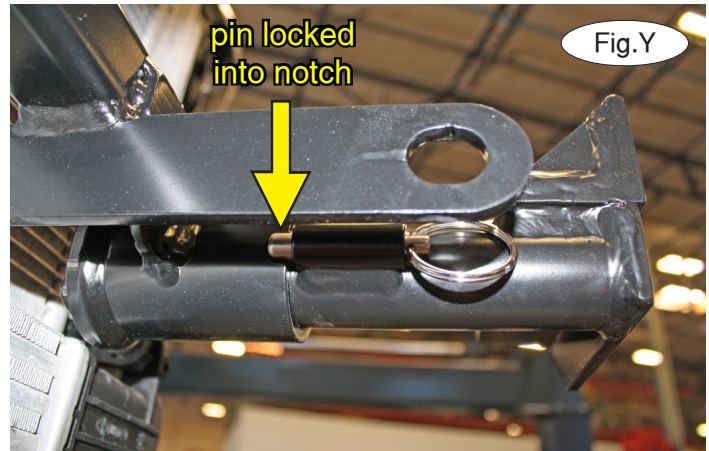
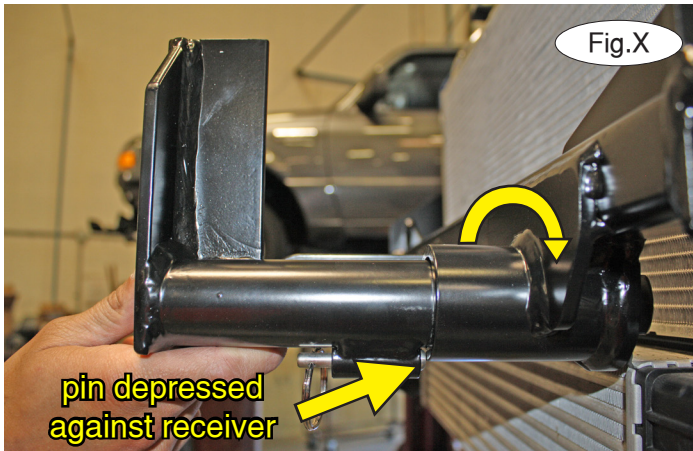

20. On each side, insert the removable front bracket arm into the front receiver 90 degrees from its final towing position, depressing the spring-loaded pin against the receiver (Fig.X). Now, twist back 90 degrees until the spring-loaded pin snaps into place in the notch on the receiver, locking the arm into place in its final towing position (Fig.Y).

**Please note: it is the owner's responsibility to ensure the locking of the pins before towing. Otherwise, failure of the towing system will result.**

21. Install the tow bar to the mounting bracket according to the manufacturer's instructions.

### **IMPORTANT!**

**Safety cables are required by law. When towing, connect safety cables to the safety cable tabs shown in Figure Z. Make certain there is adequate slack in the cables to allow a full turning radius; otherwise, damage will result. If necessary, longer cables or cable extensions are available.**

*Note:* if the bracket is so equipped, the holes in the alignment tabs which are welded to the arms and main receivers are for padlocks only. Under no circumstances should you bolt the alignment tabs together. Bolting the alignment tabs together may result in non-warranty damage to the bracket.

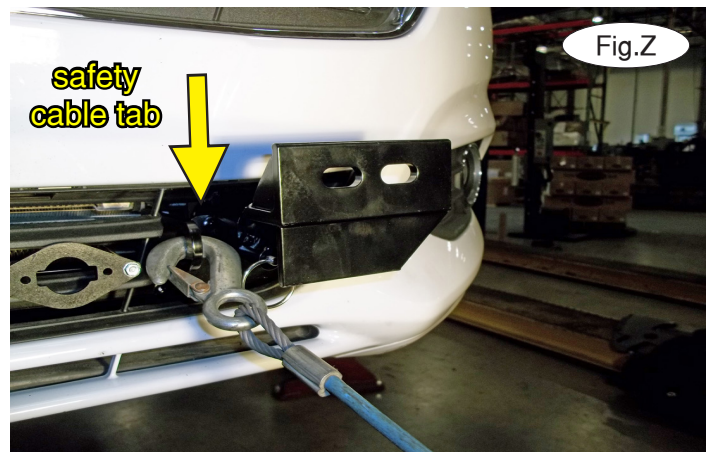



# BASEPLATE KIT INSTALLATION INSTRUCTIONS

**KIT# 524434-4**

08/09/13  
KS

ROADMASTER, Inc. 6110 NE 127th Ave. Vancouver, WA 98682 360-896-0407 fax 360-735-9300 www.roadmasterinc.com

## Three options for attaching the wiring plug to the main receiver brace

**For six-wire plugs:** use the two supplied 3/4" self-tapping screws to attach the electrical plug directly to the rods on the front of the main receiver brace.

**For four-wire round plugs:** attach to the plug mounting plate and then use the two supplied 3/4" self-tapping screws to attach the mounting plate to the rods on the front of the main receiver brace.

**For four-wire flat plugs:** place the plug through the mounting plug plate, and then secure it using the supplied zip tie on the front of the plug (Fig.AA). Use the two supplied 3/4" self-tapping screws to attach the mounting plate to the rods on the front of the main receiver brace.

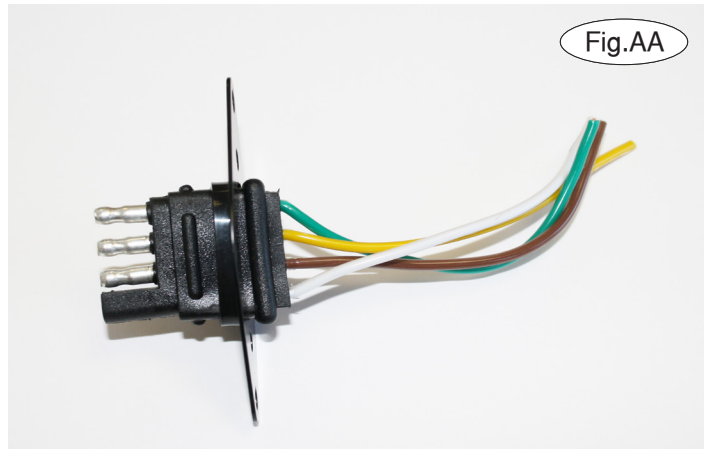

## BOLT TORQUE REQUIREMENTS

Note: The torque values represented below are intended as general guidelines. Torque requirements for specific applications may vary. Roadmaster does not warrant this information to be accurate for all applications and disclaims all liability for any claims or damages which may result from its use.

### STANDARD BOLTS

Thread Size	Grade	Torque
5/16.....	5.....	13 ft./lb.
3/8.....	5.....	23 ft./lb.
7/16.....	5.....	37 ft./lb.
1/2.....	5.....	56 ft./lb.
5/8.....	5.....	150 ft./lb.

### METRIC BOLTS

Thread Size	Grade	Plated / Unplated
8mm-1.0.....	8.8.....	20 ft./lb. 18 ft./lb.
8mm-1.25.....	8.8.....	19 ft./lb. 18 ft./lb.
10mm-1.25.....	8.8.....	38 ft./lb. 36 ft./lb.
10mm-1.5.....	8.8.....	37 ft./lb. 35 ft./lb.

### METRIC BOLTS

Thread Size	Grade	Plated / Unplated
12mm-1.25.....	8.8.....	70 ft./lb. 65 ft./lb.
12mm-1.5.....	8.8.....	66 ft./lb. 61 ft./lb.
12mm-1.75.....	8.8.....	65 ft./lb. 60 ft./lb.
14mm-2.0.....	8.8.....	104 ft./lb. 97 ft./lb.

All illustrations and specifications contained herein are based on the latest information available at the time of publication approval. ROADMASTER, INC. reserves the right to make changes at any time without notice in material, specification and models or to discontinue models.