



# BASEPLATE KIT INSTALLATION INSTRUCTIONS

**KIT# 524440-4A**

04/05/17  
KS

ROADMASTER, Inc. 6110 NE 127th Ave. Vancouver, WA 98682 360-896-0407 fax 360-735-9300 www.roadmasterinc.com

*Special tools needed:  
plastic pop rivet gun*

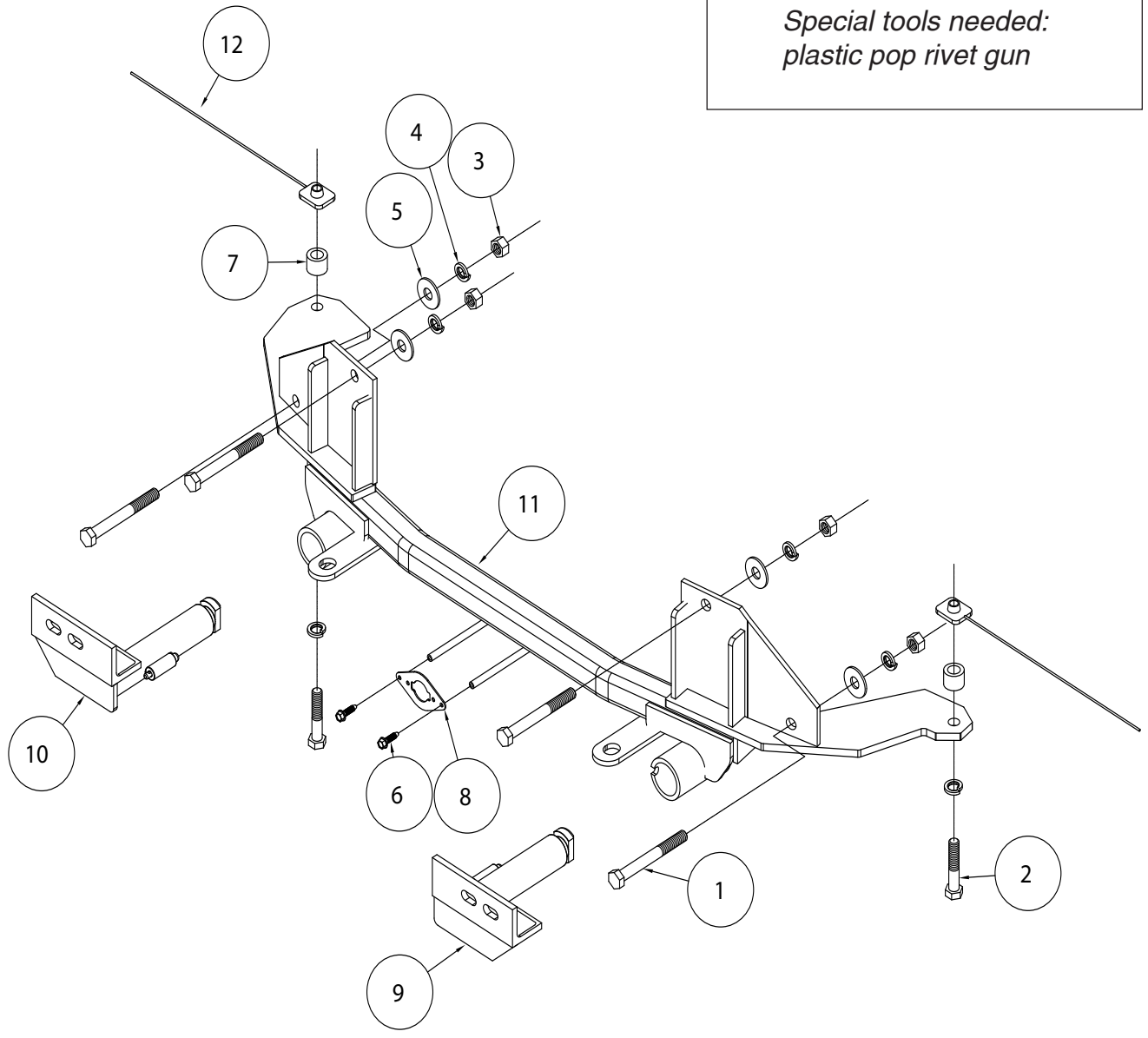

ITEM	QTY	NAME	PART #
1	4	1/2" x 4 1/2" BOLT	350106-00
2	2	1/2" x 2 1/2" BOLT	350099-00
3	4	1/2" HEX NUT	350258-00
4	6	1/2" LOCK WASHER	350309-00
5	4	1/2" FLAT WASHER	350308-00
6	2	#10 x 3/4" SELF DRILLING SCREW	350247-35
7	2	1" x 3/4" SPACER	A-000112
8	1	WIRE PLUG PLATE	A-003801
9	1	DRIVER SIDE ARM	C-002709
10	1	PASSENGER SIDE ARM	C-002710
11	1	MAIN RECEIVER	C-002711
12	2	1 1/4" x 1 1/2" THREADED BACKING PLATE W/12" ROD	C-002712
13	3	PLASTIC POP RIVET	350431-00



# BASEPLATE KIT INSTALLATION INSTRUCTIONS

**KIT# 524440-4A**

04/05/17  
KS

ROADMASTER, Inc. 6110 NE 127th Ave. Vancouver, WA 98682 360-896-0407 fax 360-735-9300 www.roadmasterinc.com

This is one of our EZ4 Twistlock series brackets, which allows the visible front portion of the bracket to be easily removed from the front of the vehicle (Fig.A and Fig.B). The bracket consists of a main receiver brace, two removable front braces and a hardware pack.

The main receiver brace mounts to the bumper core and frame rails. The removable front braces install in the main receiver brace.

Before starting the installation, lay out the kit components in order, as they will be used. This will give you a visual idea of how the components work, and will also confirm that everything is present and accounted for.



**IMPORTANT:** All baseplates **must** be assembled with all the bolts left loose for final adjustment and positioning (before tightening) unless otherwise instructed. All bolts **must** be torqued for proper strength. If more than one bolt is used per fastening point, the diagram may only show one. Use flat washers over all slotted holes and lock washers on all fasteners.

## WARNING

Failure to heed these warnings or follow the installation instructions may result in a voided warranty, loss of towed vehicle, personal injury or death.

- Do not weld or modify this baseplate or its components. Welding or modification will void the warranty.
- Do not use this document as a basis to design/fabricate a baseplate, as it may not show all parts or structural components.
- We strongly recommend professional installation.
- If the towed vehicle has been in an accident, it must be properly repaired before attaching the baseplate. Do not install the baseplate if any structural frame damage is found.
- The installer must use all bolts and parts supplied. If running changes were made by the vehicle manufacturer after this kit was designed, some bolts or other fasteners may no longer be the correct size. It is the installer's responsibility to verify this kit is securely fastened to the vehicle.
- Use Loctite® Red on all bolts used to secure this baseplate. Torque all bolts to the specifications found at the end of these instructions. Do not over-torque the bolts or failure may occur.
- The installer must inspect the baseplate to ensure adequate clearance, particularly around hoses, air conditioner lines, radiators, etc. or non-warranty failure may result.
- Roadmaster manufactures many styles of baseplates. If your baseplate has removable arms, they must be removed before driving the vehicle, unless the arms can be pinned or padlocked in place. If not secured, the arms could vibrate out.
- Some motorhome chassis have such a tight turning radius that you can damage your motorhome, towed vehicle, tow bar or baseplate while turning sharply. Before getting on the road, test your turning radius in an empty parking lot. Turning too sharply could result in non-warranty damage to your towing system, motorhome and/or towed vehicle.
- Do not back up with the towed vehicle attached or non-warranty damage will occur to your towing system or vehicles.
- The safety cables must connect the towing vehicle to the towed vehicle frame to frame, with the cables crossed, with enough slack for sharp turns. See cable instructions for proper routing. Failure to do so will result in non-warranty damage and/or the loss of the towed vehicle.
- This kit is designed for use with ROADMASTER tow bars and ROADMASTER adapters only. Using this kit with other brands, without an approved ROADMASTER adapter, may result in non-warranty damage or injury.
- Receiver extensions and out-of-level towing situations of 3 inches or more. This can cause the system to swing much higher and lower, causing excessive strain on the tow bar, baseplate and frame. That can cause the towing system to fail, causing property damage, personal injury or even death. If you must use a receiver extension or drop hitch to tow, it will reduce your receiver's weight capacity by 1/3 to avoid damaging your system. Never use more than one extension and/or drop hitch, as this will void your warranty.
- Every 3,000 miles, the owner must inspect all mounting points for cracks or fatigue, and check the fasteners for proper torque, according to the bolt torque requirements chart on the last page of these instructions.
- The owner must follow the vehicle manufacturer's instructions to prepare the vehicle for towing. Failure to do so may cause severe damage to the vehicle.
- This baseplate is only warranted for the original installation. Installing a used baseplate on another vehicle is not recommended and will void the warranty.



# BASEPLATE KIT INSTALLATION INSTRUCTIONS

**KIT# 524440-4A**

04/05/17  
KS

ROADMASTER, Inc. 6110 NE 127th Ave. Vancouver, WA 98682 360-896-0407 fax 360-735-9300 www.roadmasterinc.com

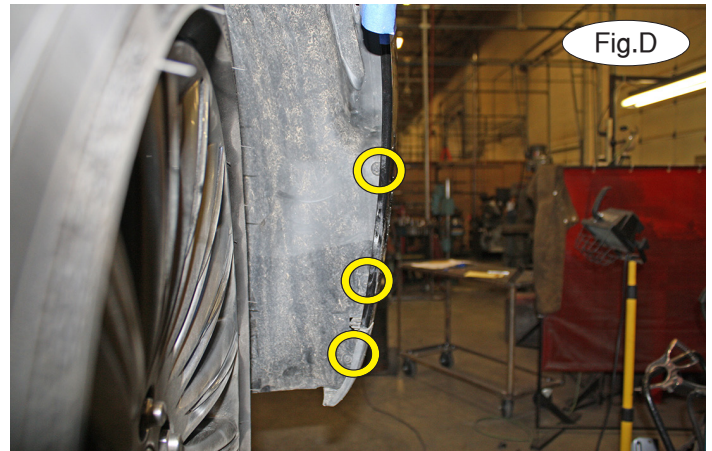
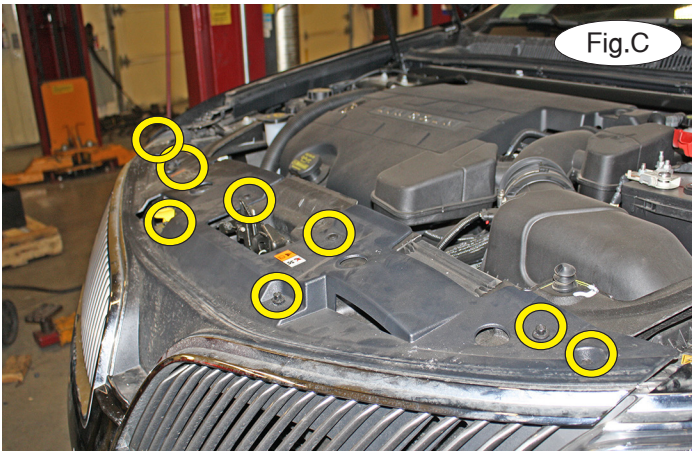

1. **Important:** please use all supplied bolts and parts and read all instructions carefully before beginning this installation. The majority of questions you may have can be answered within the text, and proper installation will ensure safe and secure travel. Now, begin the installation. Remove six 10mm (head) bolts and two plastic fasteners at attaching the top of the fascia to the core support (Fig.C).

2. On each side, remove three 5.5mm screws attaching the fender liner to the fascia (Fig.D).

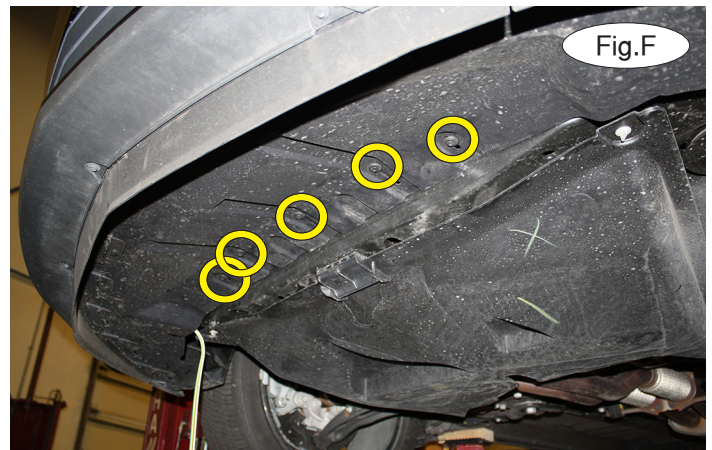

3. On each side, remove one 8mm (head) bolt attaching the fender liner to the splash shield (Fig.E). Then, remove five plastic fasteners attaching the splash shield to the core support (Fig.F).

4. On the driver's side only, pull out on the fender liner and disconnect the large wiring harness (Fig.G).

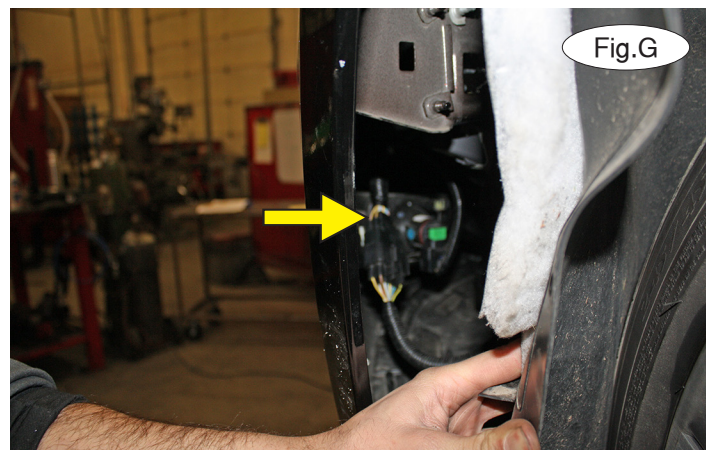



# BASEPLATE KIT INSTALLATION INSTRUCTIONS

**KIT# 524440-4A**

04/05/17  
KS

ROADMASTER, Inc. 6110 NE 127th Ave. Vancouver, WA 98682 360-896-0407 fax 360-735-9300 www.roadmasterinc.com

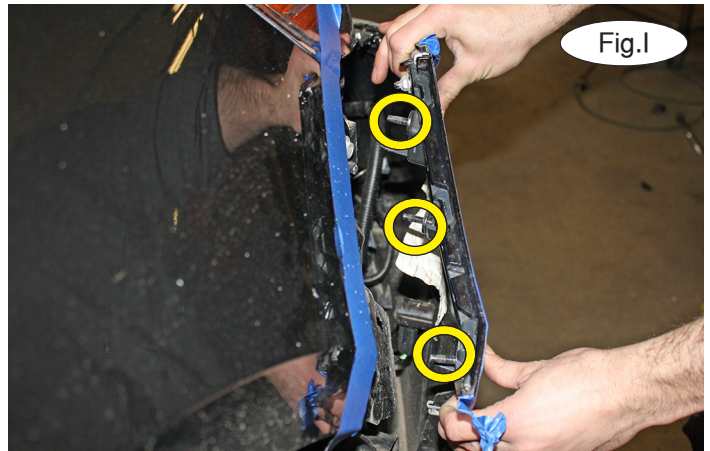
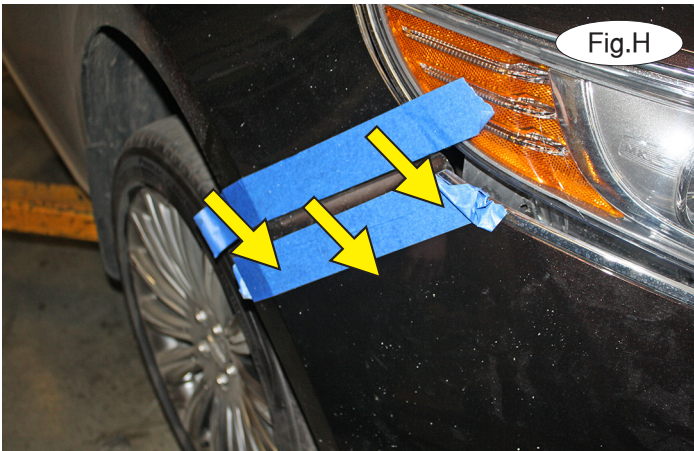

5. On each side, reach up inside the fender liner and behind the fascia and remove three 10mm nuts attaching the corner of the fascia to the fender. Their approximate location is shown in Figure H. Figure I also shows the studs.
6. Pull out and forward carefully on each corner of the fascia to remove it (Fig.I).

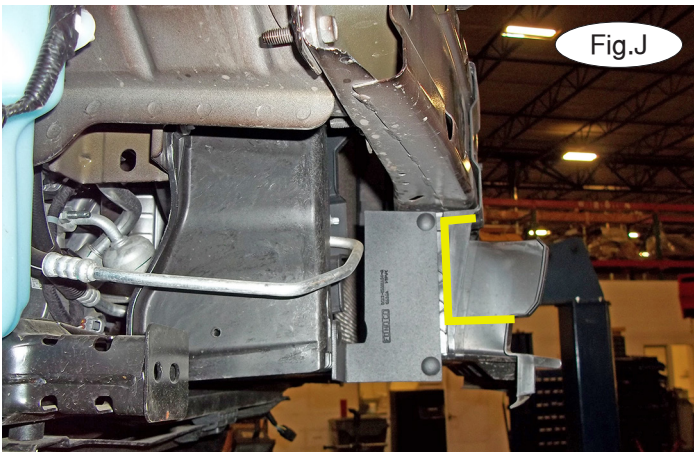

7. On each side, trim the louver housing as shown in Figure J.
8. On the driver's side, carefully maneuver the main receiver brace between the bumper core and the Active Cruise Control sensor. (Fig.K). Ensure it is flush with the bottom and the face of the bumper core and then clamp it in place (Fig.L). **Note:** Figure M shows where the bracket should be flush. **Caution! Under no circumstances should you attempt to move, adjust or disconnect the ACC unit (indicated in red in Figure L). Doing so may cause cruise control malfunction and/or computer error codes that may require the dealership to repair or reset.**

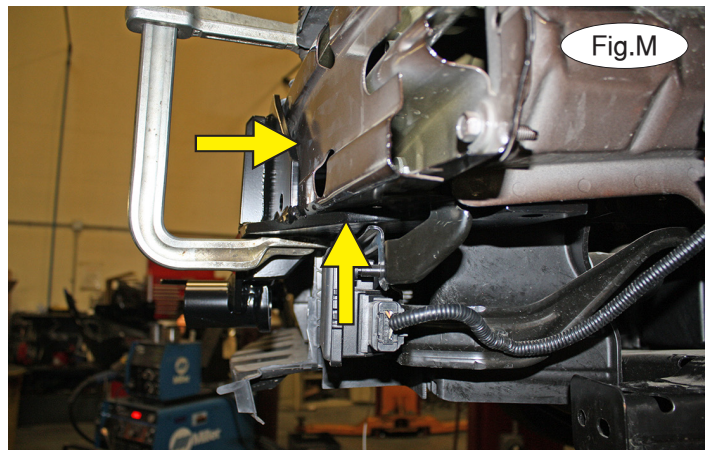
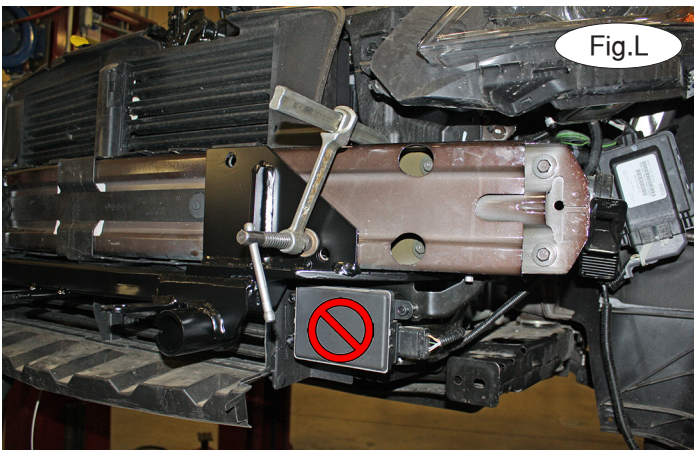



# BASEPLATE KIT INSTALLATION INSTRUCTIONS

**KIT# 524440-4A**

04/05/17  
KS

ROADMASTER, Inc. 6110 NE 127th Ave. Vancouver, WA 98682 360-896-0407 fax 360-735-9300 www.roadmasterinc.com

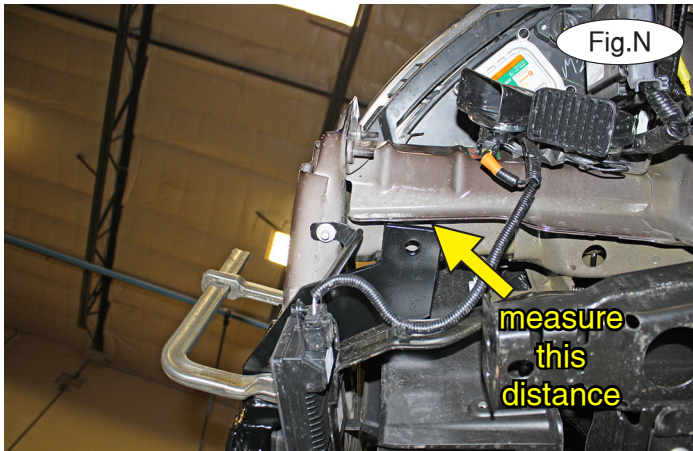

9. On each side, measure the space between the bracket and the pinch weld to ensure that they are the same on both sides of the vehicle (Fig.N).

10. On each side, drill a ½" hole up through the bottom mounting hole of the main receiver brace (Fig.O).

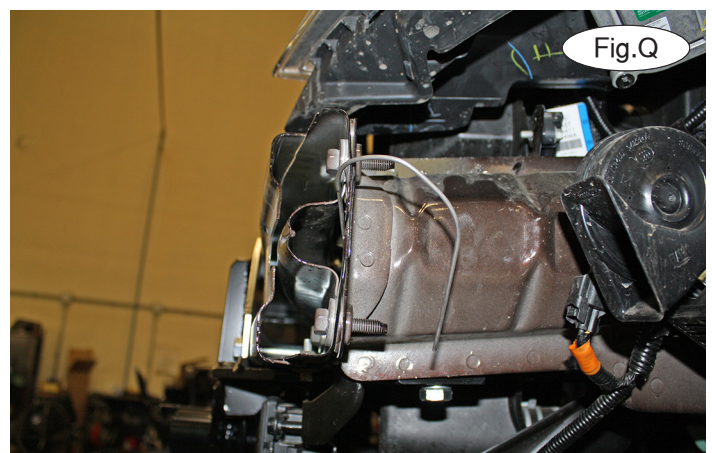
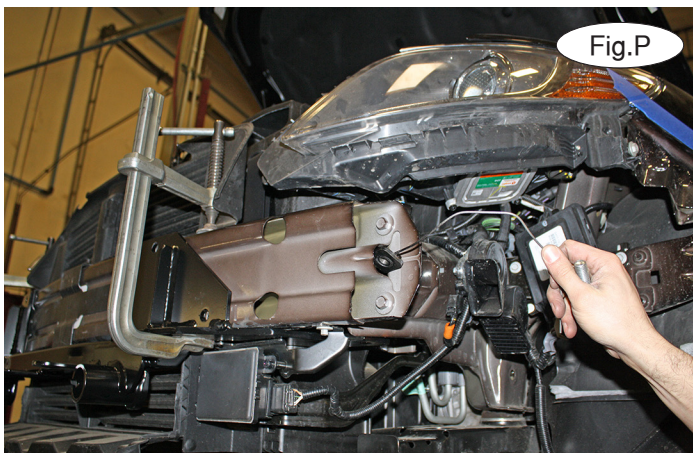

11. On each side, place one of the supplied ¾" x 1" x .188 wall pipe spacers between the main receiver brace and the frame rail, over the hole you drilled in the previous step. Now, place one of the supplied 3/16" x 1¼" x 1½" threaded backing plates with rod into the end of the frame rail and over the pipe spacer (Fig.P). Then, place a ½" lock washer over a ½" x 2½" bolt and bolt through the main receiver brace, pipe spacer, frame rail and into the threaded backing plate (Fig.Q). *Note:* ensure proper alignment, as the bolts will receive Loctite® Red and will be torqued at the end of these instructions.

12. On each side, using the two forwardmost mounting points of the main receiver brace as templates for drilling, drill all the way through the bumper core (Fig.R). *Note:* make certain to use the proper length drill bit to avoid drilling into engine components.





# BASEPLATE KIT INSTALLATION INSTRUCTIONS

**KIT# 524440-4A**

04/05/17  
KS

ROADMASTER, Inc. 6110 NE 127th Ave. Vancouver, WA 98682 360-896-0407 fax 360-735-9300 www.roadmasterinc.com

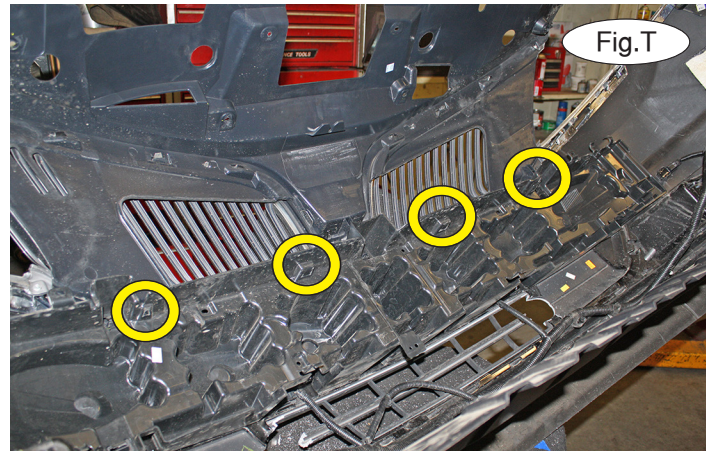
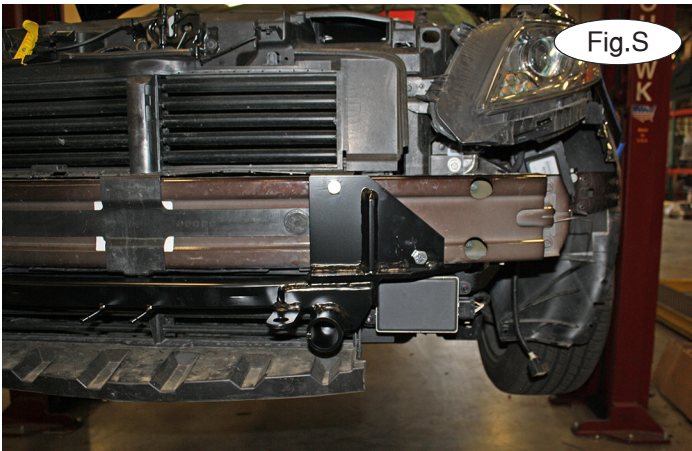

13. On each side, using two of the supplied  $\frac{1}{2}$ " x  $4\frac{1}{2}$ " bolts, bolt through the two holes you drilled in the previous step and finish with two  $\frac{1}{2}$ " flat washers, lock washers and nuts (Fig.S).

14. Tighten all bolts to the bolt torque requirements found at the end of these instructions. *Note:* use Loctite® Red on all nuts and bolts.

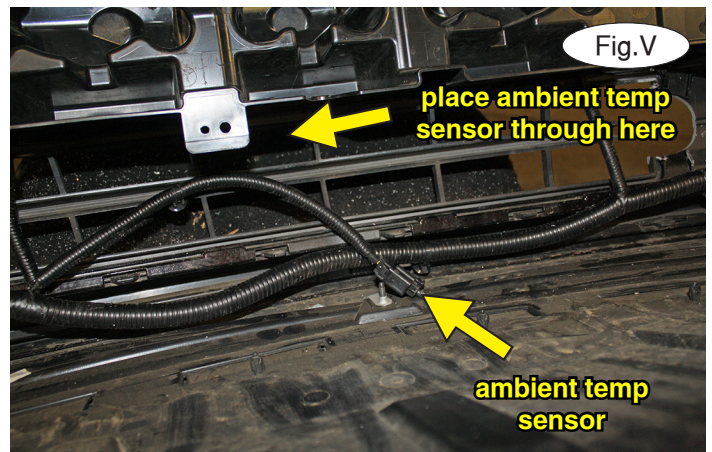
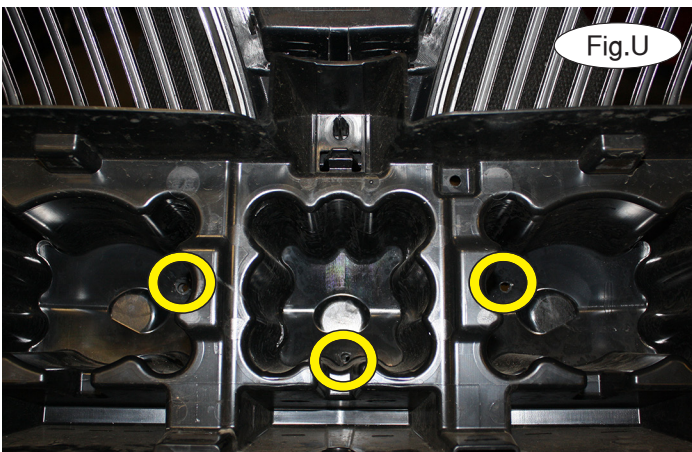

15. Disconnect the wiring harness and the ambient temperature sensor from the shock absorption pad and then release the four clips attaching the shock absorption pad to the back of the fascia (Fig.T). *Note:* if the vehicle is equipped with a riveted license plate holder, use a  $\frac{1}{4}$ " drill to drill out the three rivets attaching the license plate frame to the fascia to remove the shock absorption pad (Fig.U). It will not be replaced. Retain the shock absorption pad in case the bracket is ever removed. If you drilled out the pop rivets, use the supplied pop rivets to replace the license plate holder.

16. Run the wiring loom along the bottom of the fascia and place the ambient temperature sensor through the upper center hole of the grille opening (Fig.V). *Note:* it will be secured in a future step.



# BASEPLATE KIT INSTALLATION INSTRUCTIONS

**KIT# 524440-4A**

04/05/17  
KS

ROADMASTER, Inc. 6110 NE 127th Ave. Vancouver, WA 98682 360-896-0407 fax 360-735-9300 www.roadmasterinc.com

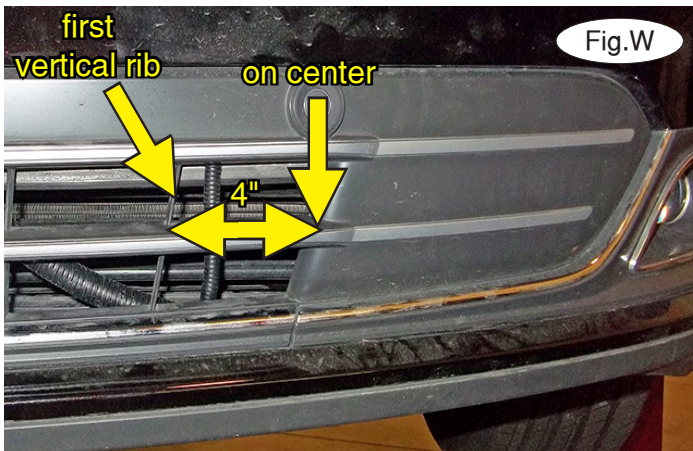

17. Hold the fascia in place over the main receiver brace. On each side, locate the first vertical rib and measure 4" toward the outside of the vehicle, mark on center in the center of the middle rib and cut a hole approximately 2" in diameter to allow clearance for the receiver (Fig.W and Fig.X).

18. Reinstall the fascia, reversing steps 1 through 6.

19. Loop the supplied zip tie over the center of the ambient temperature sensor and tighten it around the wire mount plug, and then slide it back behind the grille opening (Fig.Y).



20. **Note: the following four images are for illustration purposes only, as your specific application may be slightly different.**

The spring-loaded pin on the removable arm snaps into a notch on the receiver, locking the removable arm into its final towing position. Before inserting each arm into the receiver, verify that the spring is working by ensuring that the spring-loaded pin moves easily back and forth within the barrel when pulled and that it can be pulled flush with the face of the barrel (Fig.Z and Fig.AA).





# BASEPLATE KIT INSTALLATION INSTRUCTIONS

**KIT# 524440-4A**

04/05/17  
KS

ROADMASTER, Inc. 6110 NE 127th Ave. Vancouver, WA 98682 360-896-0407 fax 360-735-9300 www.roadmasterinc.com

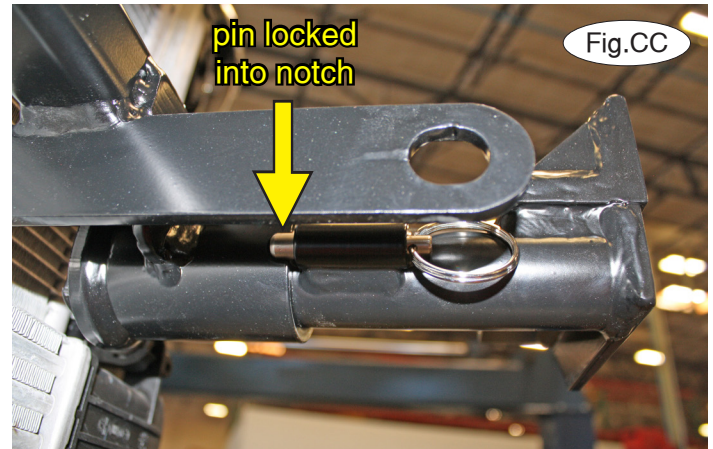
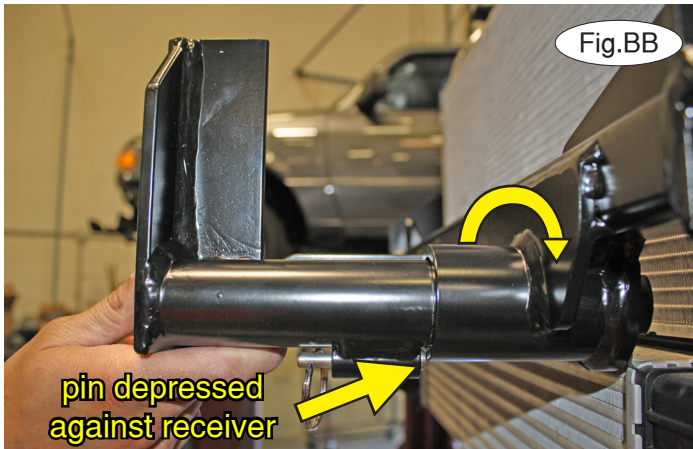

21. On each side, insert the removable front bracket arm into the front receiver 90 degrees from its final towing position, depressing the spring-loaded pin against the receiver (Fig.BB). Now, twist back 90 degrees until the spring-loaded pin snaps into place in the notch on the receiver, locking the arm into place in its final towing position (Fig.CC).

**Please note: it is the owner's responsibility to ensure the locking of the pins before towing. Otherwise, failure of the towing system will result.**

22. Install the tow bar to the mounting bracket according to the manufacturer's instructions.

### **IMPORTANT!**

**Safety cables are required by law. When towing, connect safety cables to the safety cable tabs illustrated in Figure DD. Make certain there is adequate slack in the cables to allow a full turning radius; otherwise, damage will result. If necessary, longer cables or cable extensions are available.**

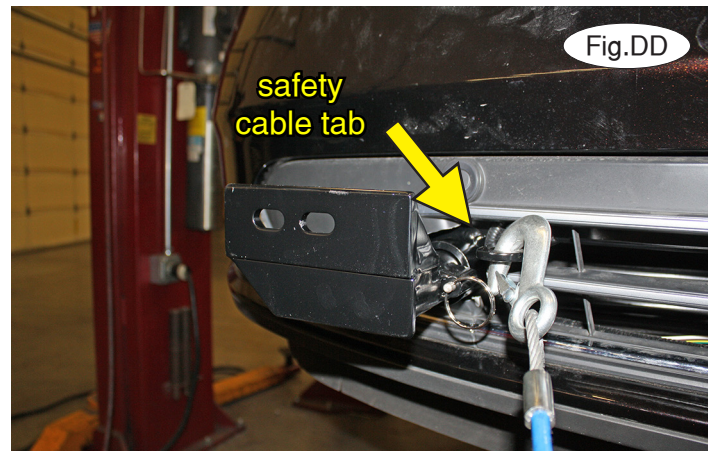



# BASEPLATE KIT INSTALLATION INSTRUCTIONS

**KIT# 524440-4A**

04/05/17  
KS

ROADMASTER, Inc. 6110 NE 127th Ave. Vancouver, WA 98682 360-896-0407 fax 360-735-9300 www.roadmasterinc.com

## Three options for attaching the wiring plug to the main receiver brace

**For six-wire plugs:** use the two supplied 3/4" self-tapping screws to attach the electrical plug directly to the rods on the front of the main receiver brace.

**For four-wire round plugs:** attach to the plug mounting plate and then use the two supplied 3/4" self-tapping screws to attach the mounting plate to the rods on the front of the main receiver brace.

**For four-wire flat plugs:** place the plug through the mounting plug plate, and then secure it using the supplied zip tie on the front of the plug (Fig.EE). Use the two supplied 3/4" self-tapping screws to attach the mounting plate to the rods on the front of the main receiver brace.

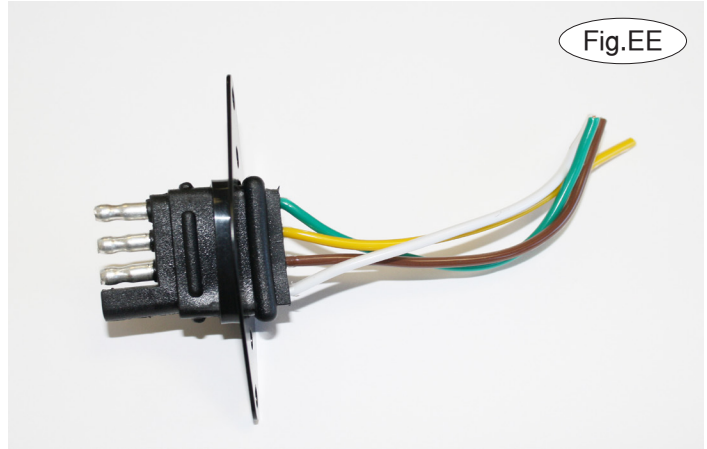

## BOLT TORQUE REQUIREMENTS

Note: The torque values represented below are intended as general guidelines. Torque requirements for specific applications may vary. Roadmaster does not warrant this information to be accurate for all applications and disclaims all liability for any claims or damages which may result from its use.

### STANDARD BOLTS

Thread Size	Grade	Torque
5/16.....	5.....	13 ft./lb.
3/8.....	5.....	23 ft./lb.
7/16.....	5.....	37 ft./lb.
1/2.....	5.....	56 ft./lb.
5/8.....	5.....	150 ft./lb.

### METRIC BOLTS

Thread Size	Grade	Plated / Unplated
8mm-1.0.....	8.8.....	20 ft./lb. 18 ft./lb.
8mm-1.25.....	8.8.....	19 ft./lb. 18 ft./lb.
10mm-1.25.....	8.8.....	38 ft./lb. 36 ft./lb.
10mm-1.5.....	8.8.....	37 ft./lb. 35 ft./lb.

### METRIC BOLTS

Thread Size	Grade	Plated / Unplated
12mm-1.25.....	8.8.....	70 ft./lb. 65 ft./lb.
12mm-1.5.....	8.8.....	66 ft./lb. 61 ft./lb.
12mm-1.75.....	8.8.....	65 ft./lb. 60 ft./lb.
14mm-2.0.....	8.8.....	104 ft./lb. 97 ft./lb.

All illustrations and specifications contained herein are based on the latest information available at the time of publication approval. ROADMASTER, INC. reserves the right to make changes at any time without notice in material, specification and models or to discontinue models.