



BASEPLATE KIT INSTALLATION INSTRUCTIONS

KIT# 524442-4

07/19/17
KS

ROADMASTER, Inc. 6110 NE 127th Ave. Vancouver, WA 98682 360-896-0407 fax 360-735-9300 www.roadmasterinc.com

Special Tools Needed

Reciprocating Saw
Die Grinder

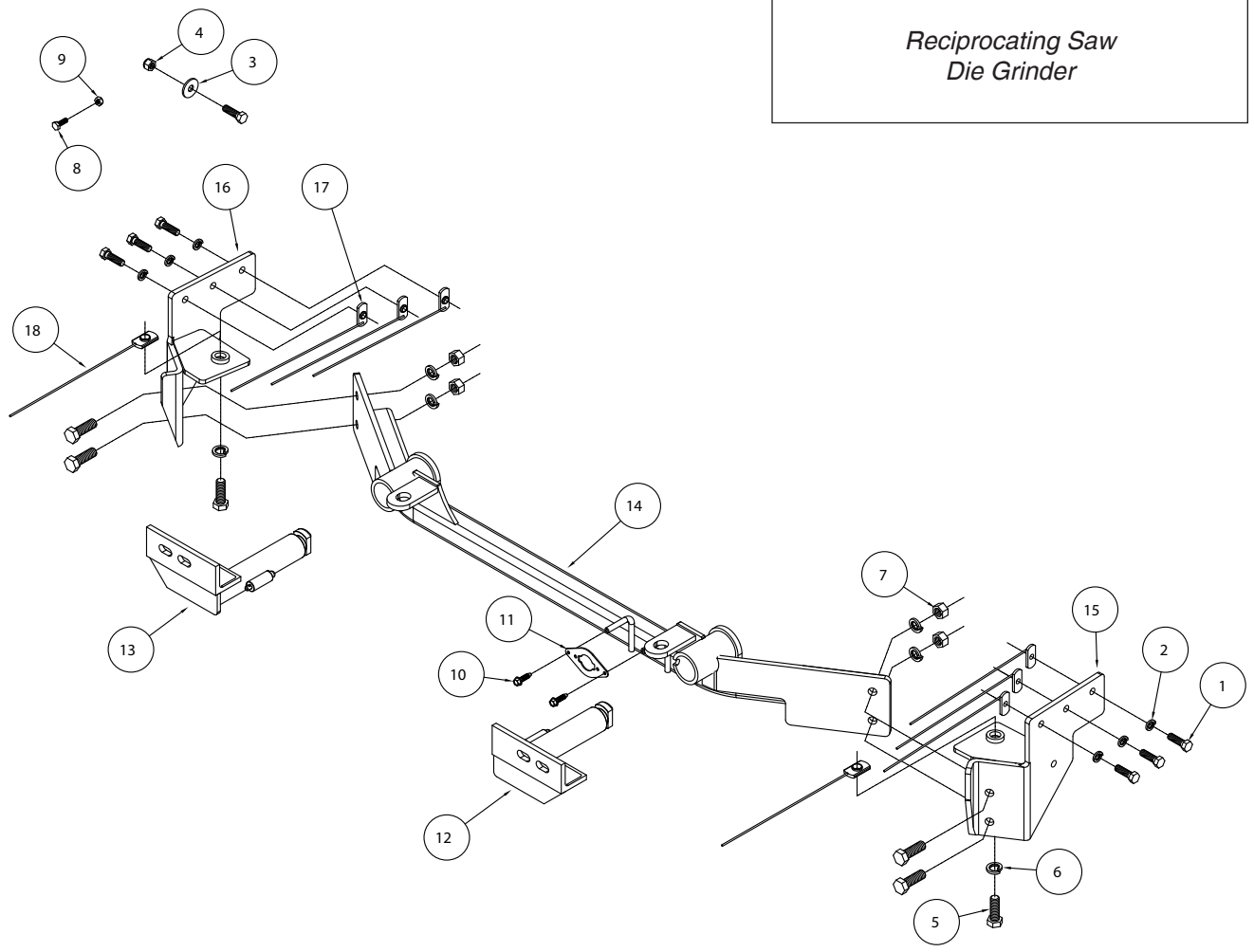

ITEM	QTY	NAME	PART #
1.....	7	3/8" x 1 1/4" BOLT	350056-00
2.....	6	3/8" LOCK WASHER	350305-00
3.....	1	3/8" FLAT WASHER	350304-00
4.....	1	3/8" NYLOCK NUT	350255-00
5.....	6	1/2" x 1 1/2" BOLT	350095-00
6.....	6	1/2" LOCK WASHER	350309-00
7.....	4	1/2" HEX NUT	350258-00
8.....	1	1/4" x 1" BOLT	350005-00
9.....	1	1/4" NYLOCK NUT	350251-00
10.....	2	#10 x 3/4" SELF DRILLING SCREW	350247-35
11.....	1	WIRE PLUG PLATE	A-003801
12.....	1	DRIVER SIDE ARM	C-002813
13.....	1	PASSENGER SIDE ARM	C-002814
14.....	1	MAIN RECEIVER	C-002815
15.....	1	DRIVER SIDE BRACE	C-002816
16.....	1	PASSENGER SIDE BRACE	C-002817
17.....	6	3/8" TAB WELDNUT WITH 10" ROD	C-002819
18.....	2	1/2" TAB WELDNUT WITH 10" ROD	C-002820



BASEPLATE KIT INSTALLATION INSTRUCTIONS

KIT# 524442-4

07/19/17
KS

ROADMASTER, Inc. 6110 NE 127th Ave. Vancouver, WA 98682 360-896-0407 fax 360-735-9300 www.roadmasterinc.com

This is one of our EZ4 Twistlock series brackets, which allows the visible front portion of the bracket to be easily removed from the front of the vehicle (Fig.A and Fig.B). The bracket consists of a main receiver brace, two support brackets, two removable front braces, and a hardware pack.

The main receiver brace mounts to the support braces. The removable front braces install in the main receiver brace.

Before starting the installation, lay out the kit components in order, as they will be used. This will give you a visual idea of how the components work, and will also confirm that everything is present and accounted for.



IMPORTANT: All baseplates **must** be assembled with all the bolts left loose for final adjustment and positioning (before tightening) unless otherwise instructed. All bolts **must** be torqued for proper strength. If more than one bolt is used per fastening point, the diagram may only show one. Use flat washers over all slotted holes and lock washers on all fasteners.

WARNING

Failure to heed these warnings or follow the installation instructions may result in a voided warranty, loss of towed vehicle, personal injury or death.

- Do not weld or modify this baseplate or its components. Welding or modification will void the warranty.
- Do not use this document as a basis to design/fabricate a baseplate, as it may not show all parts or structural components.
- We strongly recommend professional installation.
- If the towed vehicle has been in an accident, it must be properly repaired before attaching the baseplate. Do not install the baseplate if any structural frame damage is found.
- The installer must use all bolts and parts supplied. If running changes were made by the vehicle manufacturer after this kit was designed, some bolts or other fasteners may no longer be the correct size. It is the installer's responsibility to verify this kit is securely fastened to the vehicle.
- Use Loctite® Red on all bolts used to secure this baseplate. Torque all bolts to the specifications found at the end of these instructions. Do not over-torque the bolts or failure may occur.
- The installer must inspect the baseplate to ensure adequate clearance, particularly around hoses, air conditioner lines, radiators, etc. or non-warranty failure may result.
- Roadmaster manufactures many styles of baseplates. If your baseplate has removable arms, they must be removed before driving the vehicle, unless the arms can be pinned or padlocked in place. If not secured, the arms could vibrate out.
- Some motorhome chassis have such a tight turning radius that you can damage your motorhome, towed vehicle, tow bar or baseplate while turning sharply. Before getting on the road, test your turning radius in an empty parking lot. Turning too sharply could result in non-warranty damage to your towing system, motorhome and/or towed vehicle.
- Do not back up with the towed vehicle attached or non-warranty damage will occur to your towing system or vehicles.
- The safety cables must connect the towing vehicle to the towed vehicle frame to frame, with the cables crossed, with enough slack for sharp turns. See cable instructions for proper routing. Failure to do so will result in non-warranty damage and/or the loss of the towed vehicle.
- This kit is designed for use with ROADMASTER tow bars and ROADMASTER adapters only. Using this kit with other brands, without an approved ROADMASTER adapter, may result in non-warranty damage or injury.
- Receiver extensions and out-of-level towing situations of 3 inches or more. This can cause the system to swing much higher and lower, causing excessive strain on the tow bar, baseplate and frame. That can cause the towing system to fail, causing property damage, personal injury or even death. If you must use a receiver extension or drop hitch to tow, it will reduce your receiver's weight capacity by 1/3 to avoid damaging your system. Never use more than one extension and/or drop hitch, as this will void your warranty.
- Every 3,000 miles, the owner must inspect all mounting points for cracks or fatigue, and check the fasteners for proper torque, according to the bolt torque requirements chart on the last page of these instructions.
- The owner must follow the vehicle manufacturer's instructions to prepare the vehicle for towing. Failure to do so may cause severe damage to the vehicle.
- This baseplate is only warranted for the original installation. Installing a used baseplate on another vehicle is not recommended and will void the warranty.



BASEPLATE KIT INSTALLATION INSTRUCTIONS

KIT# 524442-4

07/19/17
KS

ROADMASTER, Inc. 6110 NE 127th Ave. Vancouver, WA 98682 360-896-0407 fax 360-735-9300 www.roadmasterinc.com



1. **Important:** please use all supplied bolts and parts and read all instructions carefully before beginning this installation. The majority of questions you may have can be answered within the text, and proper installation will ensure safe and secure travel. Now, begin the installation. Start by removing four plastic fasteners and two T30 torx screws attaching the fascia to the core support (Fig.C).

2. On each side, remove two T30 torx screws attaching the headlights to the vehicle (Figure D). Disconnect the headlights, and set aside for now.

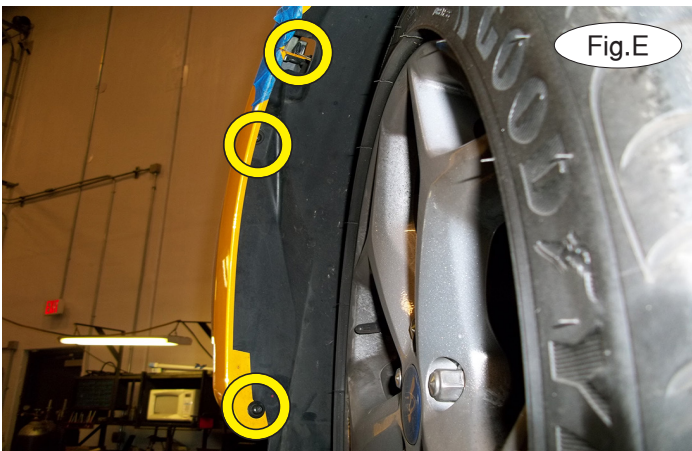

3. On each side, remove one plastic fastener and two T27 Torx screws attaching the fascia to the fender and the fender liner (Fig.E).

4. Now, on each side, remove three plastic fasteners and two T27 Torx screws attaching the splash shield to the fascia and fender liner (Fig.F).

5. Pry the hood latch cable from the lever bracket, and then disconnect the cable from the lever (Fig.G).





BASEPLATE KIT INSTALLATION INSTRUCTIONS

KIT# 524442-4

07/19/17
KS

ROADMASTER, Inc. 6110 NE 127th Ave. Vancouver, WA 98682 360-896-0407 fax 360-735-9300 www.roadmasterinc.com

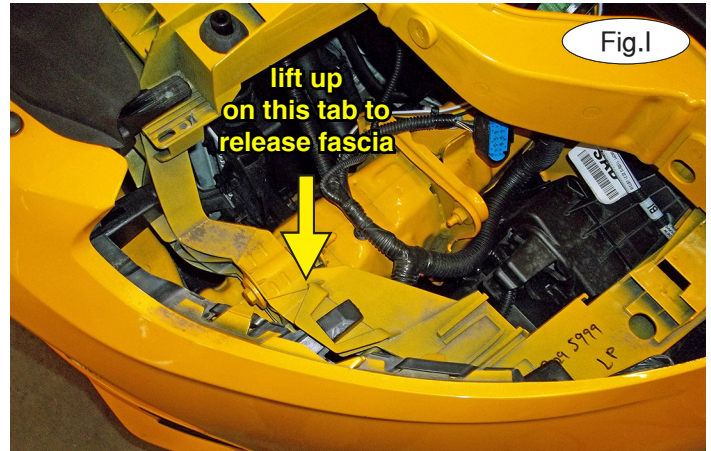
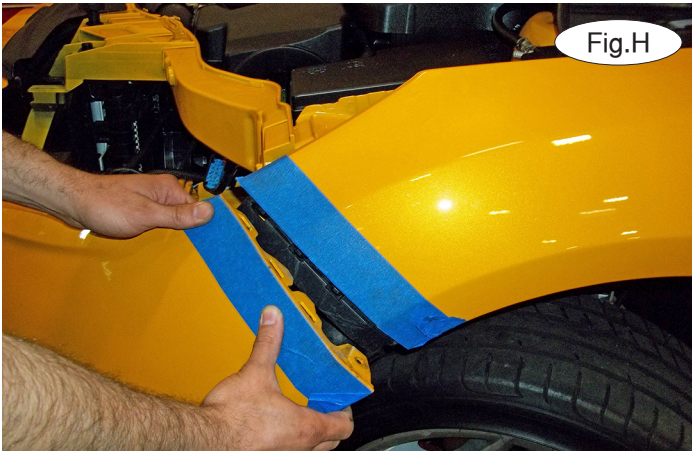

6. On each side, remove the fascia by pulling out on the corners to release the locking strip (Fig.H), and then lift up on the core support tabs (Fig.I).

7. Remove two T30 torx screws attaching the louver cowling to the frame (Fig.J). The louver cowling will not be replaced. *Note:* retain the louver cowling and attachment hardware so that it can be replaced if the bracket is ever removed.

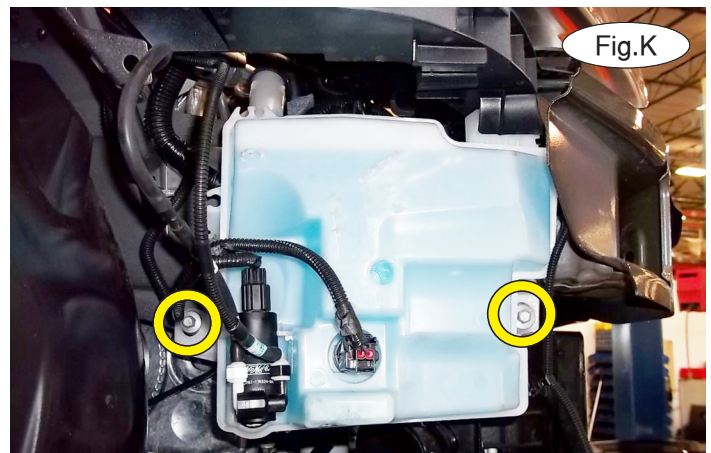

8. On the passenger side only, remove two 10mm (head) bolts attaching the washer bottle to the frame (Fig.K). Slide the bottle back to remove it. Drain the washer bottle, to be refilled later, or secure it away from the frame.

9. Now, remove one 10mm (head) bolt attaching the horns to the frame (Fig.L).

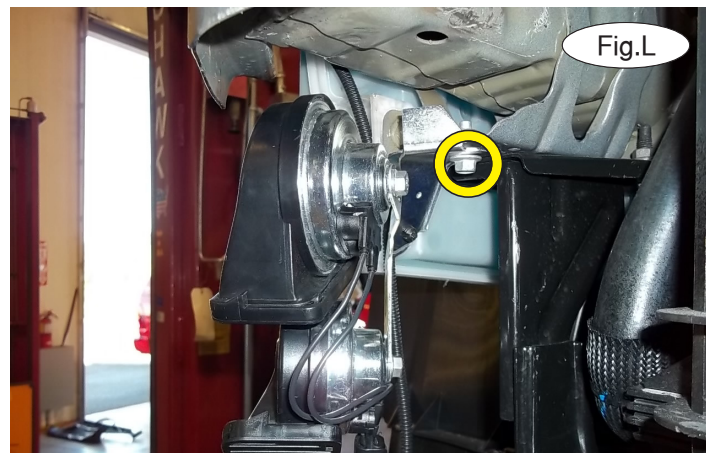



BASEPLATE KIT INSTALLATION INSTRUCTIONS

KIT# 524442-4

07/19/17
KS

ROADMASTER, Inc. 6110 NE 127th Ave. Vancouver, WA 98682 360-896-0407 fax 360-735-9300 www.roadmasterinc.com



10. Now, use a reciprocating saw to remove the washer bottle and horn bracket using the yellow line in Figure M as a reference for trimming.

11. On each side, use a ½" drill bit to drill through the face of the bumper, in line with the center of the frame rail. Then, enlarge the hole to 1½" using a die grinder. This will allow access to the interior of the frame rail. Figure N shows the completed drilling indicated with a yellow arrow.



12. Place the driver's side support bracket against the side of the frame, aligning the three holes in the bracket with the existing holes in the frame. Then, temporarily place 3/8" x 1¼" bolts in the two outermost holes. Place one of the 3/8" tab weldnut with rod into the frame rail and align it with the center hole of the support bracket (Fig.O). Bend the rod as necessary to fit it in the frame rail. Now, place one of the supplied 3/8" lock washers over a 3/8" x 1¼" bolt and bolt through the center hole of the support bracket and into the 3/8" tab weldnut with rod. Repeat for the remaining two outer holes on each side after removing the bolts.

13. On each side, place one of the supplied ½" tab weldnuts with rod inside the frame, aligning it with the hole in the bottom of the frame and the support bracket. Place a ½" lock washer over a ½" x 1½" bolt and bolt through the support bracket and into the tab weldnut (Fig.P).



BASEPLATE KIT INSTALLATION INSTRUCTIONS

KIT# 524442-4

07/19/17
KS

ROADMASTER, Inc. 6110 NE 127th Ave. Vancouver, WA 98682 360-896-0407 fax 360-735-9300 www.roadmasterinc.com

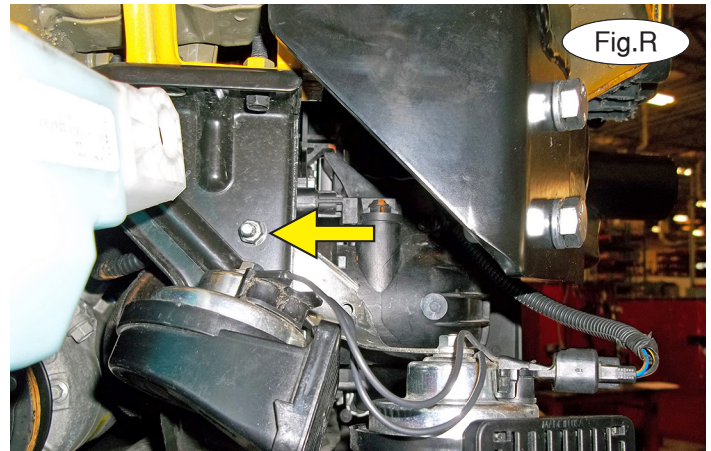

14. On each side, hold the main receiver brace up behind the support bracket. Using two $\frac{1}{2}$ " lock washers, $\frac{1}{2}$ "x 1 $\frac{1}{2}$ " bolts, and $\frac{1}{2}$ " nuts, bolt the main bracket to the support bracket (Fig.Q).

15. Use a pair of pliers to bend the horn bracket flat, and in such a way that you can mount it to the back side of the radiator support. Then, bolt the horn to the radiator support bracket using a $\frac{1}{4}$ " x 1" bolt and a $\frac{1}{4}$ " nylock nut (Fig.R).

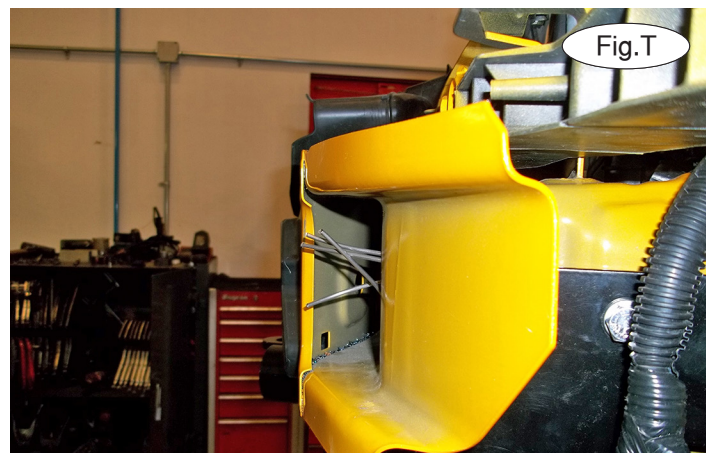
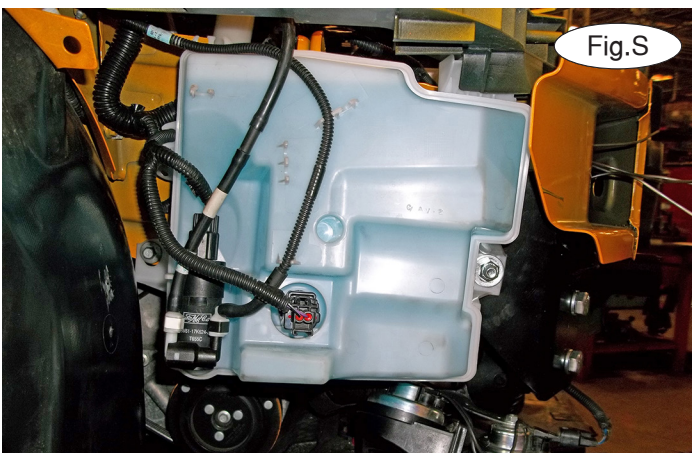

16. Reinstall the washer bottle but bolt the forwardmost mount to the side of the bracket using the supplied $\frac{3}{8}$ " x $1\frac{1}{4}$ " bolt, $\frac{3}{8}$ " washer, and $\frac{3}{8}$ " nylock nut (Fig.S).

17. On each side, trim the wire from the backing plates so they are flush with the face of the bumper core (Fig.T).

18. Tighten all bolts to the bolt torque requirements found at the end of these instructions. *Note:* use Loctite® Red on all nuts and bolts.

19. Trim the fascia as shown in Figure U as a guide to allow clearance for the main receiver brace.

20. Reinstall the fascia, reversing steps 1-6.





BASEPLATE KIT INSTALLATION INSTRUCTIONS

KIT# 524442-4

07/19/17
KS

ROADMASTER, Inc. 6110 NE 127th Ave. Vancouver, WA 98682 360-896-0407 fax 360-735-9300 www.roadmasterinc.com

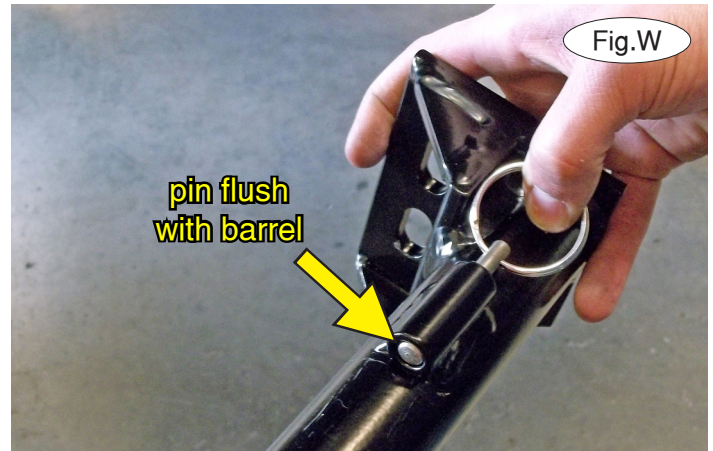
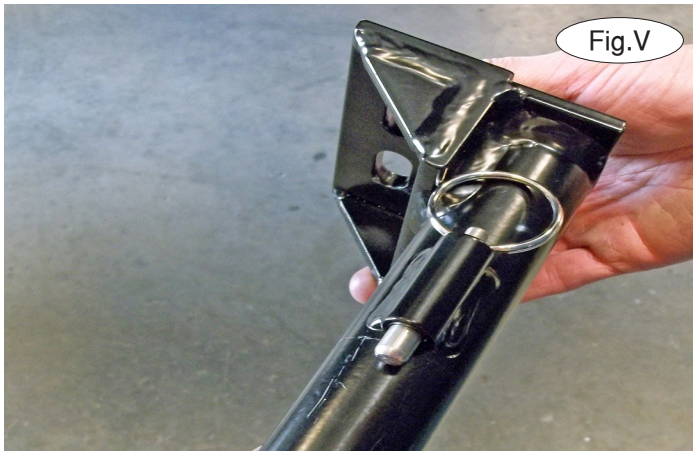

21. **Note: the following four images are for illustration purposes only, as your specific application may be slightly different.**

The spring-loaded pin on the removable arm snaps into a notch on the receiver, locking the removable arm into its final towing position. Before inserting each arm into the receiver, verify that the spring is working by ensuring that the spring-loaded pin moves easily back and forth within the barrel when pulled and that it can be pulled flush with the face of the barrel (Fig.V and Fig.W).

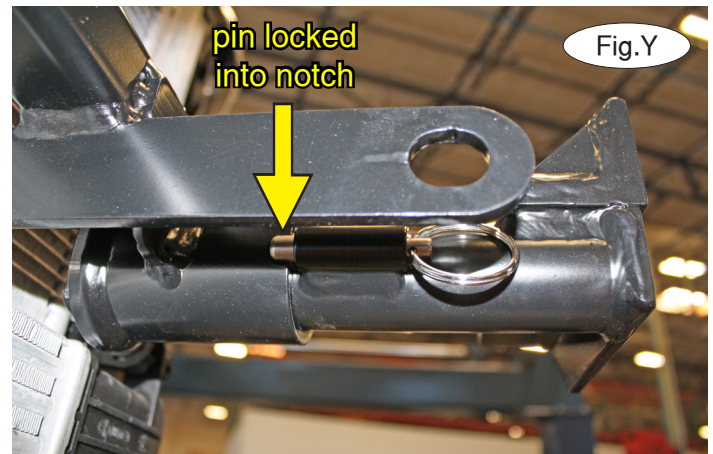
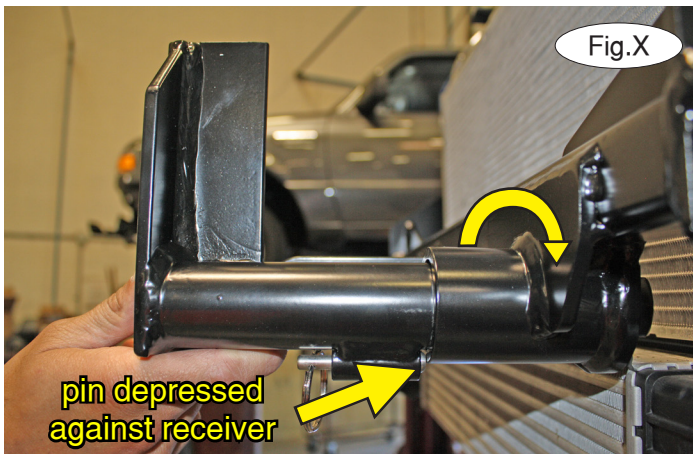

22. On each side, insert the removable front bracket arm into the front receiver 90 degrees from its final towing position, depressing the spring-loaded pin against the receiver (Fig.X). Now, twist back 90 degrees until the spring-loaded pin snaps into place in the notch on the receiver, locking the arm into place in its final towing position (Fig.Y).

Please note: it is the owner's responsibility to ensure the locking of the pins before towing. Otherwise, failure of the towing system will result.

23. Install the tow bar to the mounting bracket according to the manufacturer's instructions.



BASEPLATE KIT INSTALLATION INSTRUCTIONS

KIT# 524442-4

07/19/17
KS

ROADMASTER, Inc. 6110 NE 127th Ave. Vancouver, WA 98682 360-896-0407 fax 360-735-9300 www.roadmasterinc.com

IMPORTANT!

Safety cables are required by law. When towing, connect safety cables to the safety cable tab shown in Figure Z. Make certain there is adequate slack in the cables to allow a full turning radius; otherwise, damage will result. If necessary, longer cables or cable extensions are available.

Note: if the bracket is so equipped, the holes in the alignment tabs which are welded to the arms and main receiver braces are for padlocks only. Under no circumstances should you bolt the alignment tabs together. Bolting the alignment tabs together may result in non-warranty damage to the bracket.

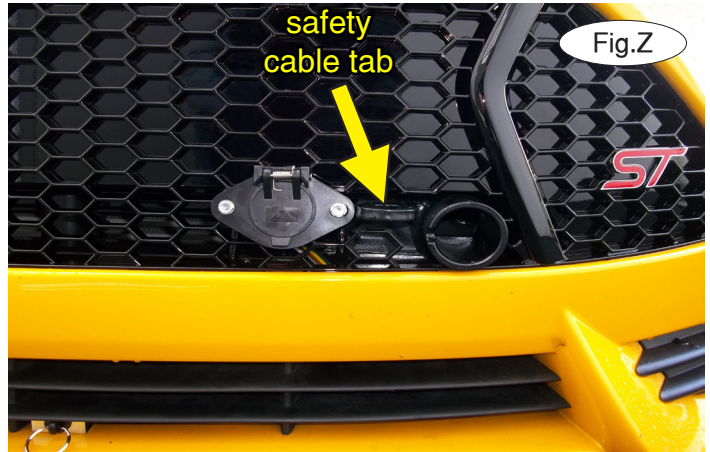

Three options for attaching the wiring plug to the main receiver brace

For six-wire plugs: use the two supplied 3/4" self-tapping screws to attach the electrical plug directly to the rods on the front of the main receiver brace.

For four-wire round plugs: attach to the plug mounting plate and then use the two supplied 3/4" self-tapping screws to attach the mounting plate to the rods on the front of the main receiver brace.

For four-wire flat plugs: place the plug through the mounting plug plate, and then secure it using the supplied zip tie on the front of the plug (Fig.AA). Use the two supplied 3/4" self-tapping screws to attach the mounting plate to the rods on the front of the main receiver brace.

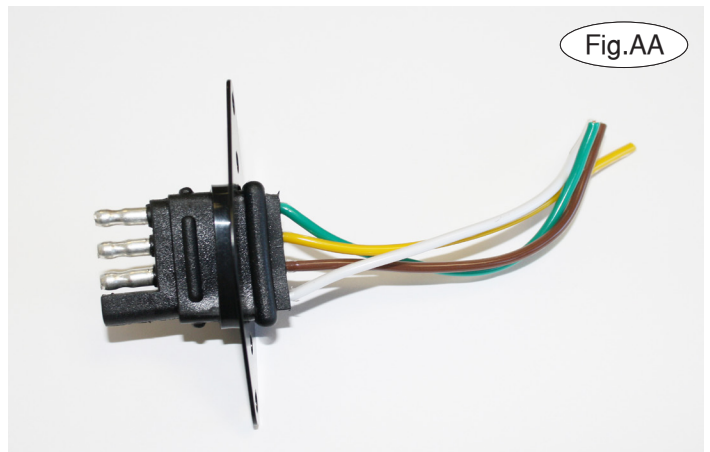

BOLT TORQUE REQUIREMENTS

Note: The torque values represented below are intended as general guidelines. Torque requirements for specific applications may vary. Roadmaster does not warrant this information to be accurate for all applications and disclaims all liability for any claims or damages which may result from its use.

STANDARD BOLTS

Thread Size	Grade	Torque
3/8.....	5.....	13 ft./lb.
3/8.....	5.....	23 ft./lb.
7/16.....	5.....	37 ft./lb.
1/2.....	5.....	56 ft./lb.
5/8.....	5.....	150 ft./lb.

METRIC BOLTS

Thread Size	Grade	Plated / Unplated
8mm-1.0.....	8.8.....	20 ft./lb. 18 ft./lb.
8mm-1.25.....	8.8.....	19 ft./lb. 18 ft./lb.
10mm-1.25.....	8.8.....	38 ft./lb. 36 ft./lb.
10mm-1.5.....	8.8.....	37 ft./lb. 35 ft./lb.

METRIC BOLTS

Thread Size	Grade	Plated / Unplated
12mm-1.25.....	8.8.....	70 ft./lb. 65 ft./lb.
12mm-1.5.....	8.8.....	66 ft./lb. 61 ft./lb.
12mm-1.75.....	8.8.....	65 ft./lb. 60 ft./lb.
14mm-2.0.....	8.8.....	104 ft./lb. 97 ft./lb.

All illustrations and specifications contained herein are based on the latest information available at the time of publication approval. ROADMASTER, INC. reserves the right to make changes at any time without notice in material, specification and models or to discontinue models.