



# BASEPLATE KIT INSTALLATION INSTRUCTIONS

**KIT# 524453-4**

12/28/17  
KS

ROADMASTER, Inc. 6110 NE 127th Ave. Vancouver, WA 98682 360-896-0407 fax 360-735-9300 www.roadmasterinc.com

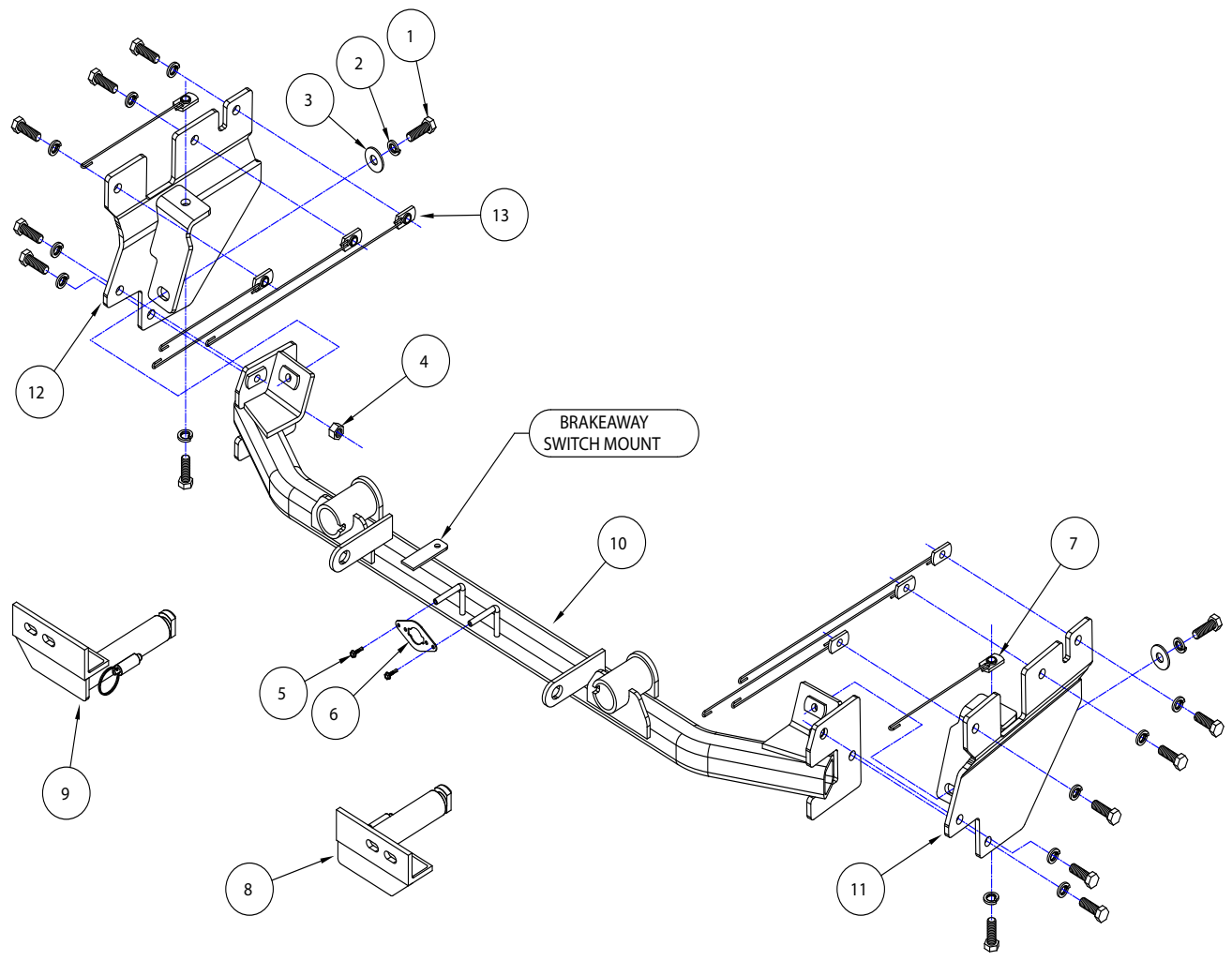

ITEM	QTY	NAME	PART #
1.....	14.....	1/2" x 1 1/2" BOLT.....	350095-00
2.....	14.....	1/2" LOCK WASHER.....	350309-00
3.....	2.....	1/2" FLAT WASHER.....	350308-00
4.....	2.....	1/2" NUT.....	350258-00
5.....	2.....	#10 x 3/4" SELF DRILLING SCREW.....	350247-35
6.....	1.....	WIRE PLUG PLATE.....	A-003801
7.....	4.....	1/2" WELD NUT WITH 8" ROD.....	C-002886
8.....	1.....	DRIVER SIDE ARM.....	C-003151
9.....	1.....	PASSENGER SIDE ARM.....	C-003152
10.....	1.....	MAIN RECEIVER BRACE.....	C-003156
11.....	1.....	DRIVER SIDE BRACE.....	C-003157
12.....	1.....	PASSENGER SIDE BRACE.....	C-003158
13.....	4.....	1/2" WELD NUT WITH 16" ROD.....	C-003159



# BASEPLATE KIT INSTALLATION INSTRUCTIONS

**KIT# 524453-4**

12/28/17  
KS

ROADMASTER, Inc. 6110 NE 127th Ave. Vancouver, WA 98682 360-896-0407 fax 360-735-9300 www.roadmasterinc.com

This is one of our crossbar-style series, which allows the visible front portion of the baseplate to be easily removed from the front of the vehicle (Fig.A and Fig.B). This kit consists of a main receiver brace, two removable front braces, and a hardware pack.

The support braces mount to the frame and the bracket mounts to the support braces. The removable front braces install in the main receiver brace.

Before starting the installation, lay out the kit components in order, as they will be used. This will give you a visual idea of how the components work, and will also confirm that everything is present and accounted for.



**IMPORTANT:** All baseplates **must** be assembled with all the bolts left loose for final adjustment and positioning (before tightening) unless otherwise instructed. All bolts **must** be torqued for proper strength. If more than one bolt is used per fastening point, the diagram may only show one. Use flat washers over all slotted holes and lock washers on all fasteners.

## WARNING

Failure to heed these warnings or follow the installation instructions may result in a voided warranty, loss of towed vehicle, personal injury or death.

- Do not weld or modify this baseplate or its components. Welding or modification will void the warranty.
- Do not use this document as a basis to design/fabricate a baseplate, as it may not show all parts or structural components.
- We strongly recommend professional installation.
- If the towed vehicle has been in an accident, it must be properly repaired before attaching the baseplate. Do not install the baseplate if any structural frame damage is found.
- The installer must use all bolts and parts supplied. If running changes were made by the vehicle manufacturer after this kit was designed, some bolts or other fasteners may no longer be the correct size. It is the installer's responsibility to verify this kit is securely fastened to the vehicle.
- Use Loctite® Red on all bolts used to secure this baseplate. Torque all bolts to the specifications found at the end of these instructions. Do not over-torque the bolts or failure may occur.
- The installer must inspect the baseplate to ensure adequate clearance, particularly around hoses, air conditioner lines, radiators, etc. or non-warranty failure may result.
- Roadmaster manufactures many styles of baseplates. If your baseplate has removable arms, they must be removed before driving the vehicle, unless the arms can be pinned or padlocked in place. If not secured, the arms could vibrate out.
- Some motorhome chassis have such a tight turning radius that you can damage your motorhome, towed vehicle, tow bar or baseplate while turning sharply. Before getting on the road, test your turning radius in an empty parking lot. Turning too sharply could result in non-warranty damage to your towing system, motorhome and/or towed vehicle.
- Do not back up with the towed vehicle attached or non-warranty damage will occur to your towing system or vehicles.
- The safety cables must connect the towing vehicle to the towed vehicle frame to frame, with the cables crossed, with enough slack for sharp turns. See cable instructions for proper routing. Failure to do so will result in non-warranty damage and/or the loss of the towed vehicle.
- This kit is designed for use with ROADMASTER tow bars and ROADMASTER adapters only. Using this kit with other brands, without an approved ROADMASTER adapter, may result in non-warranty damage or injury.
- Receiver extensions and out-of-level towing situations of 3 inches or more. This can cause the system to swing much higher and lower, causing excessive strain on the tow bar, baseplate and frame. That can cause the towing system to fail, causing property damage, personal injury or even death. If you must use a receiver extension or drop hitch to tow, it will reduce your receiver's weight capacity by 1/3 to avoid damaging your system. Never use more than one extension and/or drop hitch, as this will void your warranty.
- Every 3,000 miles, the owner must inspect all mounting points for cracks or fatigue, and check the fasteners for proper torque, according to the bolt torque requirements chart on the last page of these instructions.
- The owner must follow the vehicle manufacturer's instructions to prepare the vehicle for towing. Failure to do so may cause severe damage to the vehicle.
- This baseplate is only warranted for the original installation. Installing a used baseplate on another vehicle is not recommended and will void the warranty.



# BASEPLATE KIT INSTALLATION INSTRUCTIONS

**KIT# 524453-4**

12/28/17  
KS

ROADMASTER, Inc. 6110 NE 127th Ave. Vancouver, WA 98682 360-896-0407 fax 360-735-9300 www.roadmasterinc.com

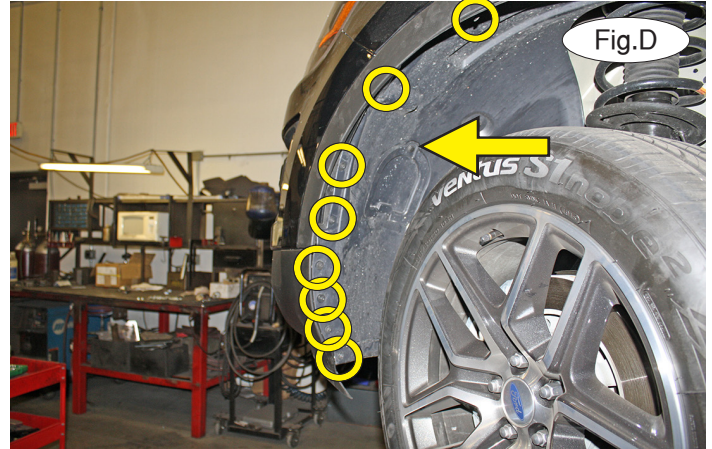
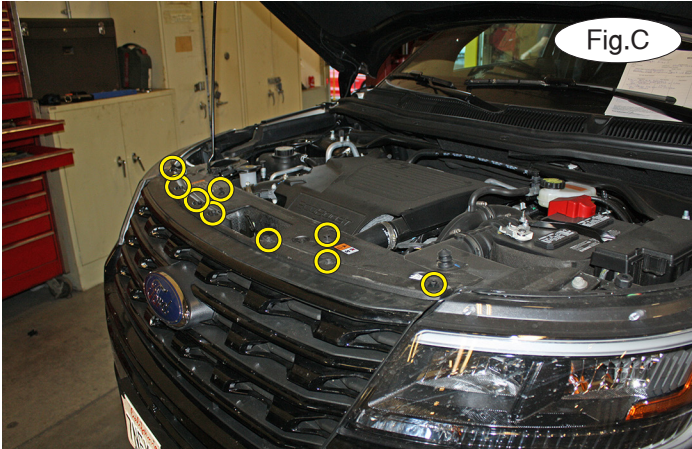

1. **Important:** please use all supplied bolts and parts and read all instructions carefully before beginning this installation. The majority of questions you may have can be answered within the text, and proper installation will ensure safe and secure travel. Now, begin the installation by removing seven 10mm (head) bolts and two plastic fasteners attaching the radiator cover to the core support (Fig.C).

2. On each side, remove seven 5.5mm (head) screws and one plastic fastener attaching the fender liner to the fascia and one plastic fastener attaching the access port to the fender liner, and then remove it (Fig.D).

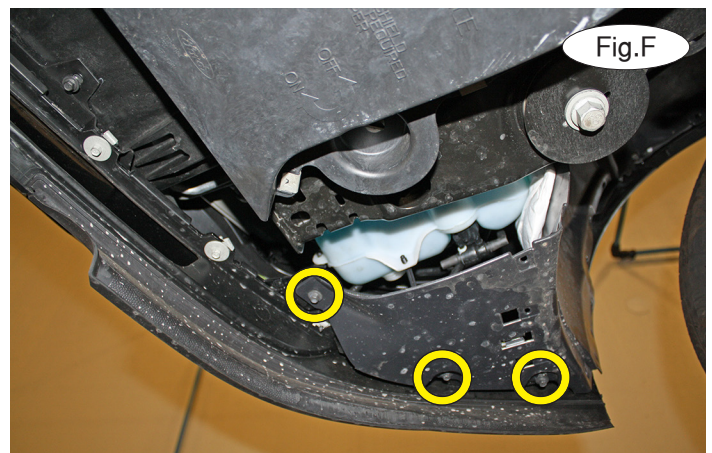
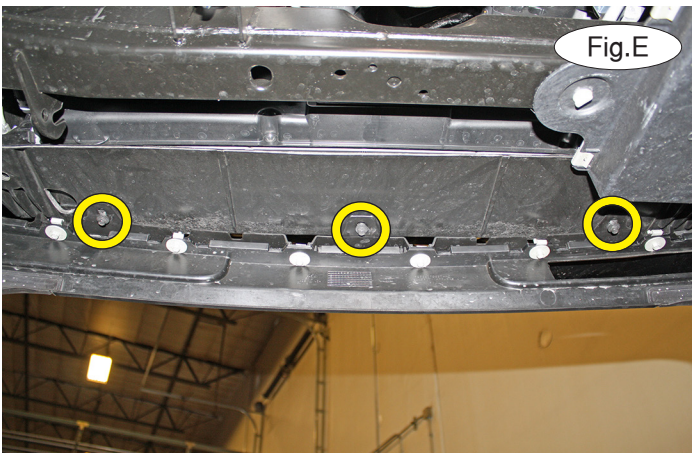

3. Remove nine 8mm (head) bolts attaching the fascia to the core support and fender liners. There are three across the middle (Fig.E) and three on each corner (Fig.F – passenger side).

4. On the driver's side only, pull out the fender liner and disconnect the main wiring harness (Fig.G).

5. On each side, pull out the three clips along the forward edge of the fender trim (Fig.H).

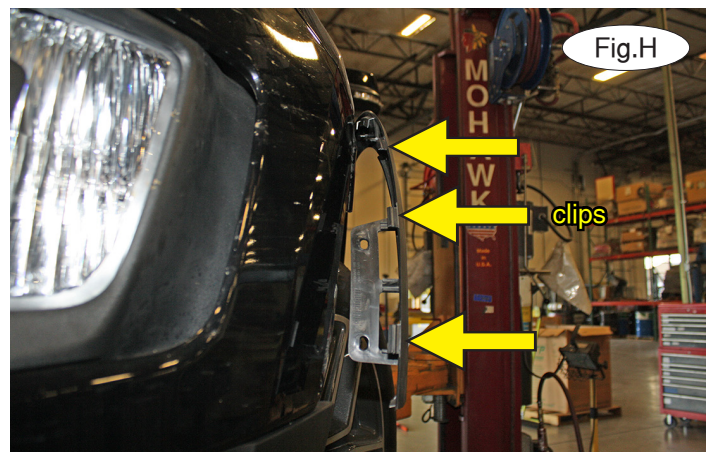



# BASEPLATE KIT INSTALLATION INSTRUCTIONS

**KIT# 524453-4**

12/28/17  
KS

ROADMASTER, Inc. 6110 NE 127th Ave. Vancouver, WA 98682 360-896-0407 fax 360-735-9300 www.roadmasterinc.com

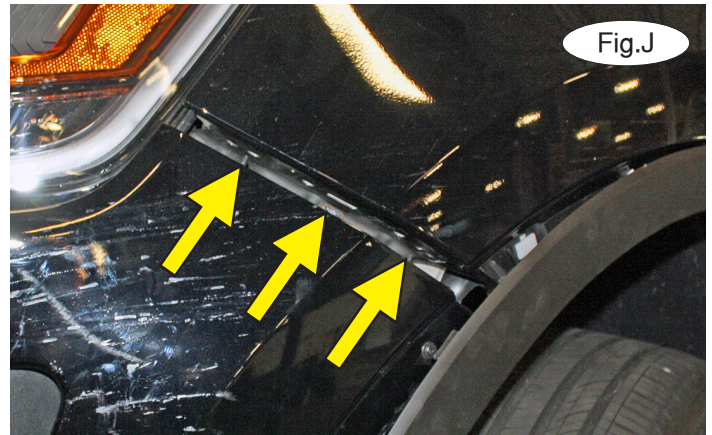
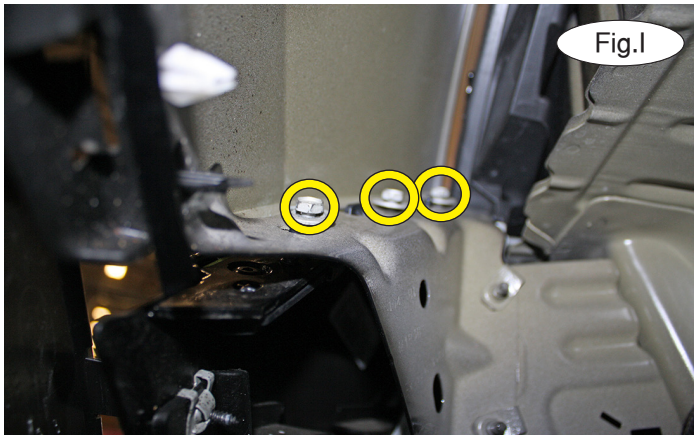

6. On each side, pull out the fender liner far enough to gain access to three 10mm (head) bolts attaching the fascia to the fender (Fig.I – passenger side). Remove them.

7. On each side, pull the fascia away from the fender, directly perpendicular to the seam to release two aligning pins and one clip (Fig.J). *Note:* it may be necessary to manually release the center clip from the inside of the fender. *Note:* depending upon the model, the fascia may still be attached via the sprayer hose at this point. The assistance of a second person may be required to hold up the fascia. Review step 8 before proceeding.

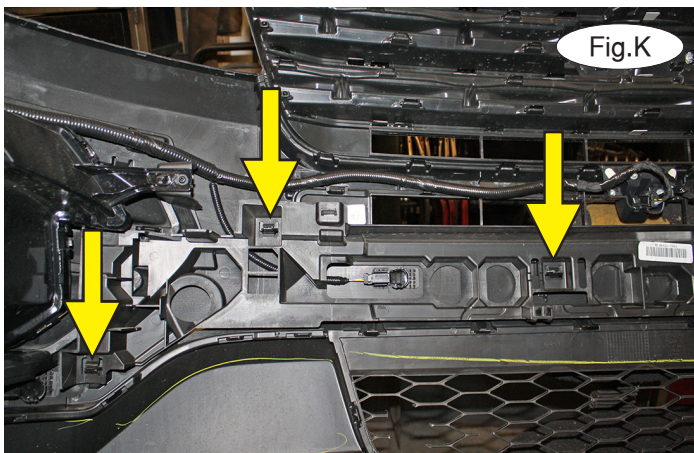

8. On the back of the fascia, release three clips on each side attaching the shock absorption pad to the back of the fascia and remove it to allow access to the front camera sprayer hose (Fig.K). Disconnect the sprayer hose and follow it, disconnecting all clips attaching it to the fascia (Fig.L), which may require holding the hose above the reservoir to avoid dripping.

9. On the passenger side only, remove two plastic fasteners attaching the wiring loom to the frame (Fig.M – circles) and remove two hoses from the plastic clip on the washer bottle (Fig.M – arrow).

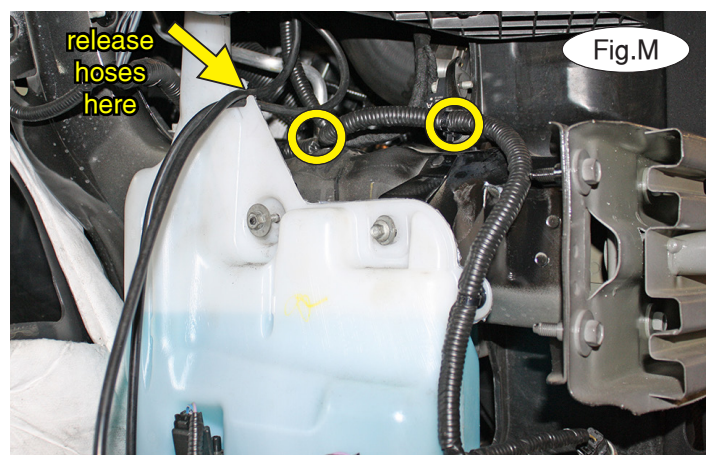



# BASEPLATE KIT INSTALLATION INSTRUCTIONS

**KIT# 524453-4**

12/28/17  
KS

ROADMASTER, Inc. 6110 NE 127th Ave. Vancouver, WA 98682 360-896-0407 fax 360-735-9300 www.roadmasterinc.com

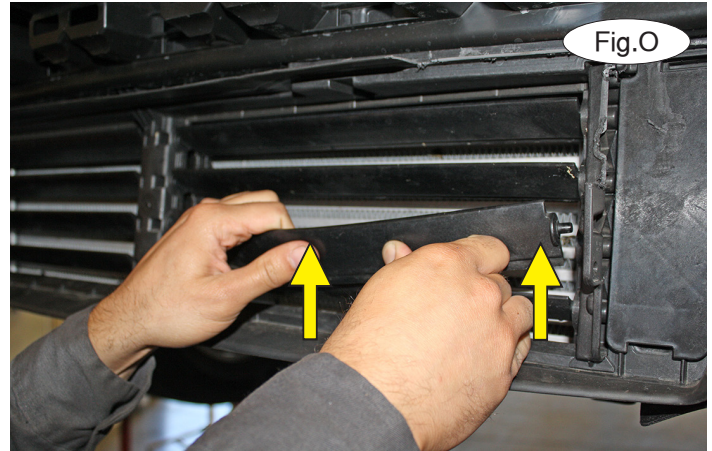
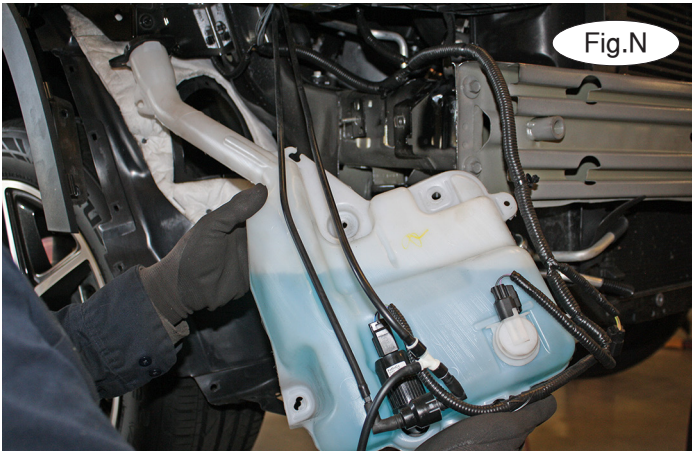

10. On the passenger side, remove one 8mm (head) bolt and two 11mm (socket) nuts attaching the washer bottle to the frame and then maneuver the washer bottle neck carefully out of the frame (Fig.N) and secure the washer bottle away from the frame for now. *Note:* if the washer bottle has a wiring harness attached to a cooling line, unplug it.

11. On each side, slightly bend the two bottom louvers to pull out the hinge pins (Fig.O). The louvers will not be replaced. *Note:* retain the louvers for replacement in case the bracket is ever removed.

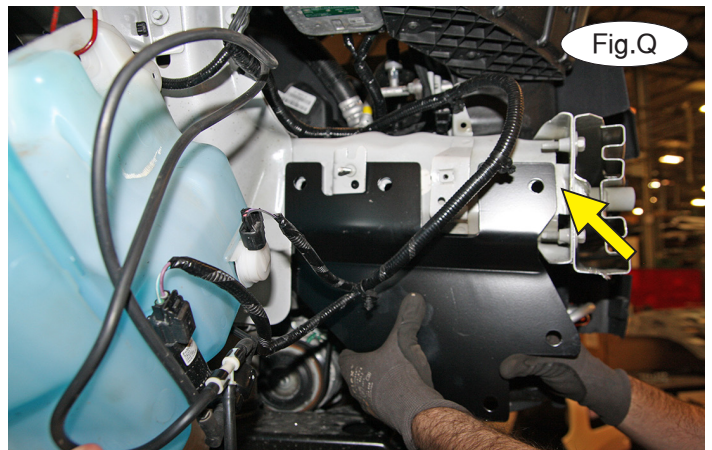
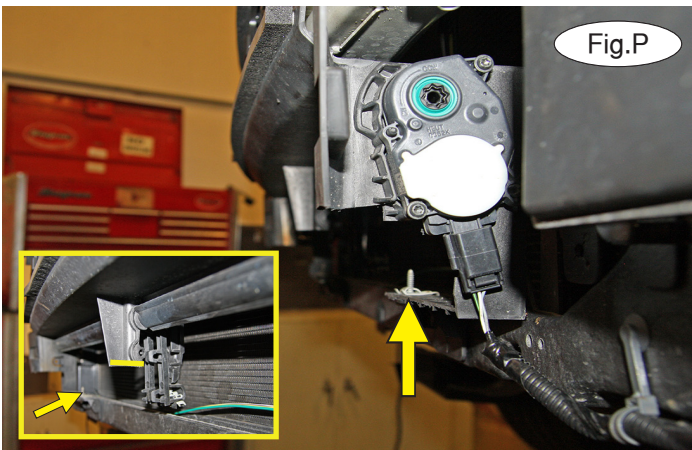

12. Completely trim off the lower half of the louver housing to allow clearance for the main receiver brace but be sure to leave the slipnuts in place (Fig.P and P, inset – arrows). *Note:* if the vehicle is equipped with a louver motor, on the driver's side, carefully cut just around the edges of it.

13. On each side, place the rear support brace against the side of the frame, aligning the forward edge with the forward edge of the sheet metal frame and against the bottom of the bumper core (Fig.Q). Mark the three side holes and the bottom hole for drilling, remove the brace and drill out the holes using a 1/2" drill (Fig.R).





# BASEPLATE KIT INSTALLATION INSTRUCTIONS

**KIT# 524453-4**

12/28/17  
KS

ROADMASTER, Inc. 6110 NE 127th Ave. Vancouver, WA 98682 360-896-0407 fax 360-735-9300 www.roadmasterinc.com

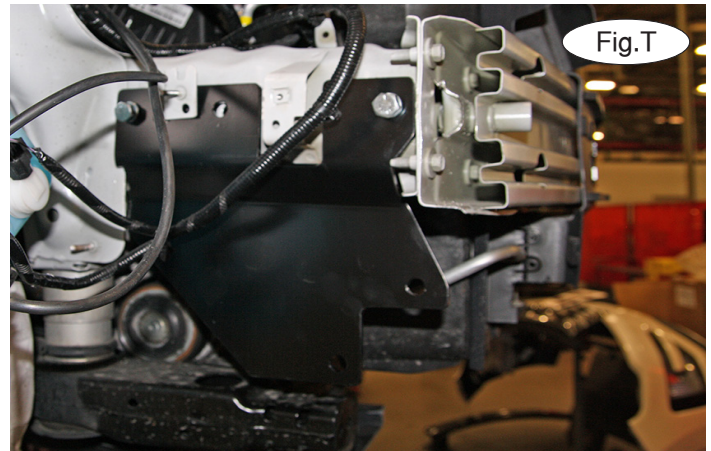
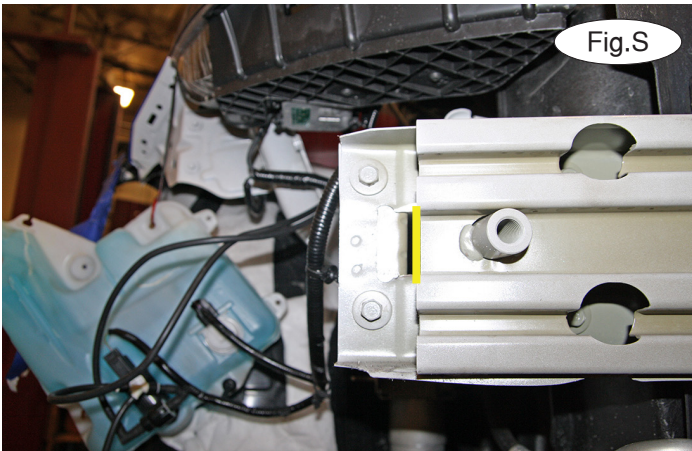

14. On each side, trim the corner of the bumper core as shown to allow clearance for the 1/2" weldnuts with wire that will be installed in future steps (Fig.S).

15. On each side, temporarily bolt the rear support brace to the frame on each side using two of the supplied 1/2" x 1 1/2" bolts in order to hold the brace against the frame (Fig.T). While the brace is supported by the two outside bolts, place one of the 1/2" weldnuts with 16" rod through the bumper core access hole you trimmed in the previous step, and into the frame and over the center hole. Bolt through the hole and into the weldnut with rod using the supplied 1/2" x 1 1/2" bolt and 1/2" lock washer. Repeat this process on the rear hole (Fig.U – circles).

Now, use the remaining weldnuts with shorter rods on the forwardmost mount and bottom hole, bolting into them using 1/2" x 1 1/2" bolts and 1/2" lock washers (Fig.U – arrow). *Note:* the bottom mount can be seen in Figure W.

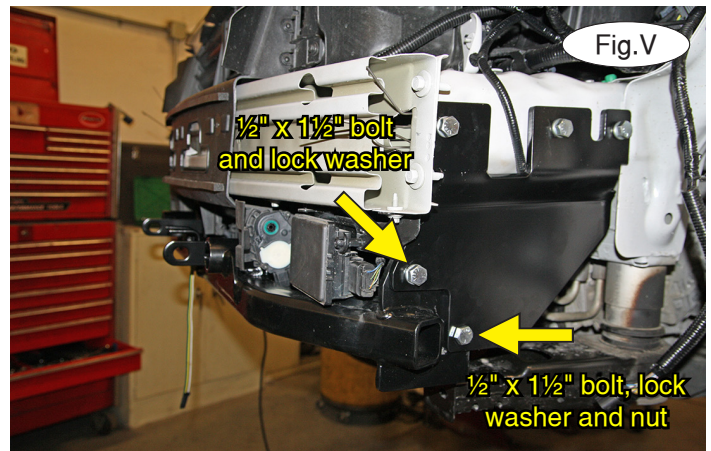
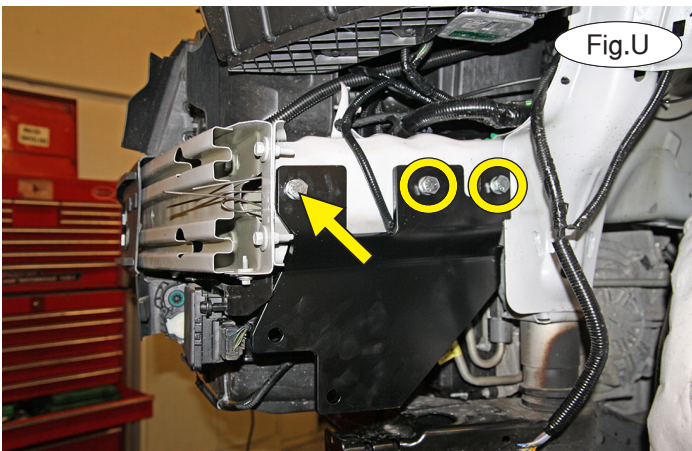

16. Lift the main receiver brace into place, aligning the existing holes with the holes in the rear support braces. On each side, bolt through the forwardmost lower mount using a 1/2" x 1 1/2" bolt and 1/2" lock washer and through the rear-most hole using a 1/2" x 1 1/2" bolt, 1/2" lock washer and 1/2" nut (Fig.V). Then, bolt through the bottom mount using a 1/2" x 1 1/2" bolt, 1/2" lock washer and 1/2" flat washer (Fig.W).

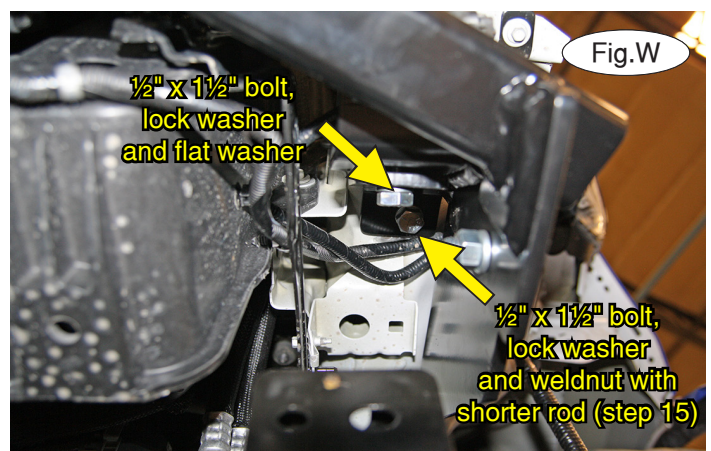



# BASEPLATE KIT INSTALLATION INSTRUCTIONS

**KIT# 524453-4**

12/28/17  
KS

ROADMASTER, Inc. 6110 NE 127th Ave. Vancouver, WA 98682 360-896-0407 fax 360-735-9300 www.roadmasterinc.com



17. Reinstall the washer bottle, reversing step 10 and using the supplied 1" x .188 wall x 1/2" pipe spacers on each mount. For the forwardmost mount, replace the factory bolt with the supplied 6mm x 1.0 x 35mm bolt, 6mm lock washer and 1/4" flat washer (Fig.X).

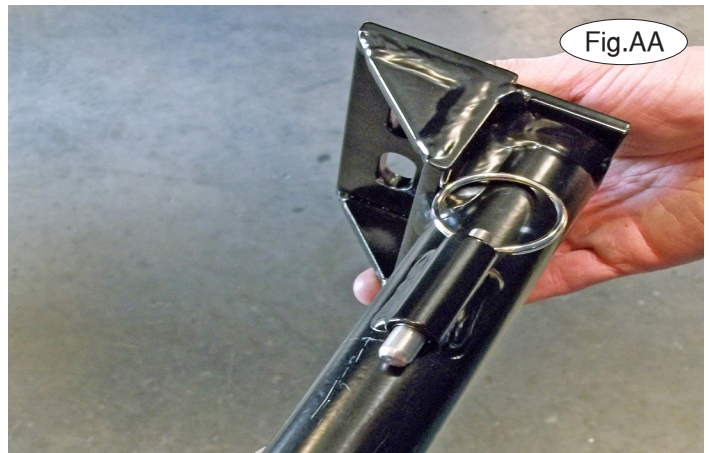

18. Tighten all bolts to the bolt torque requirements found at the end of these instructions. *Note:* use Loctite® Red on all nuts and bolts.

19. Hold the fascia over the main receiver brace and trim it as necessary to allow clearance. **For '16-'17 models:** trim as shown in Figure Y. **For '18 and later models:** trim as shown in Figure Z.

20. Reinstall the fascia, reversing steps 1 through 8.

21. *Note: the following four images are for illustration purposes only, as your specific application may be slightly different.*

The spring-loaded pin on the removable arm snaps into a notch on the receiver, locking the removable arm into its final towing position. Before inserting each arm into the receiver, verify that the spring is working by ensuring that the spring-loaded pin moves easily back and forth within the barrel when pulled and that it can be pulled flush with the face of the barrel (Fig.AA and Fig.BB).





# BASEPLATE KIT INSTALLATION INSTRUCTIONS

**KIT# 524453-4**

12/28/17  
KS

ROADMASTER, Inc. 6110 NE 127th Ave. Vancouver, WA 98682 360-896-0407 fax 360-735-9300 www.roadmasterinc.com

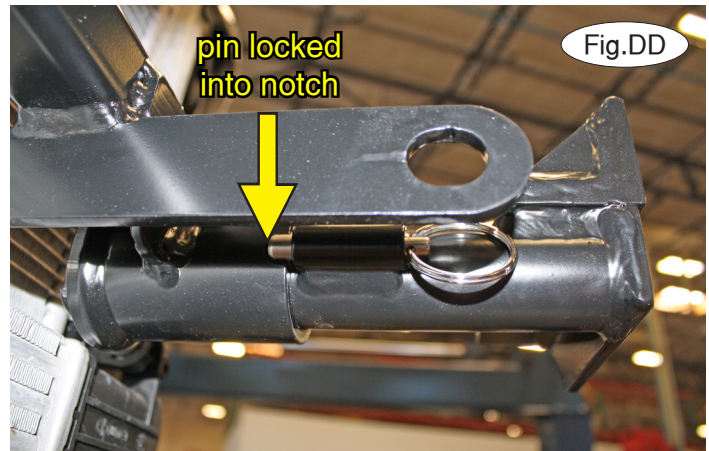
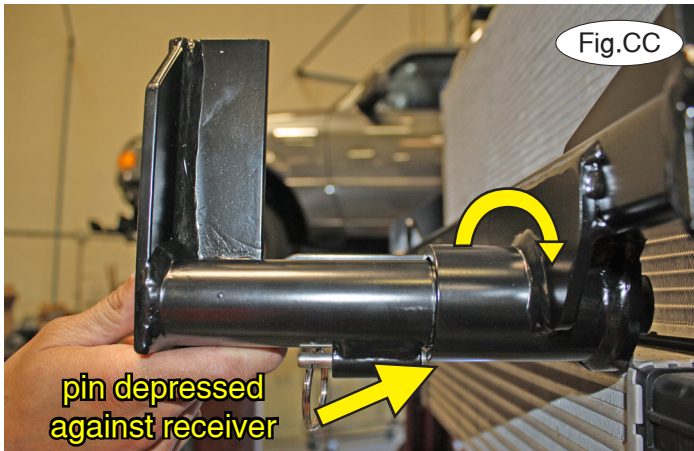

22. On each side, insert the removable front bracket arm into the front receiver 90 degrees from its final towing position, depressing the spring-loaded pin against the receiver (Fig.CC). Now, twist back 90 degrees until the spring-loaded pin snaps into place in the notch on the receiver, locking the arm into place in its final towing position (Fig.DD).

**Please note: it is the owner's responsibility to ensure the locking of the pins before towing. Otherwise, failure of the towing system will result.**

23. Install the tow bar to the mounting bracket according to the manufacturer's instructions.

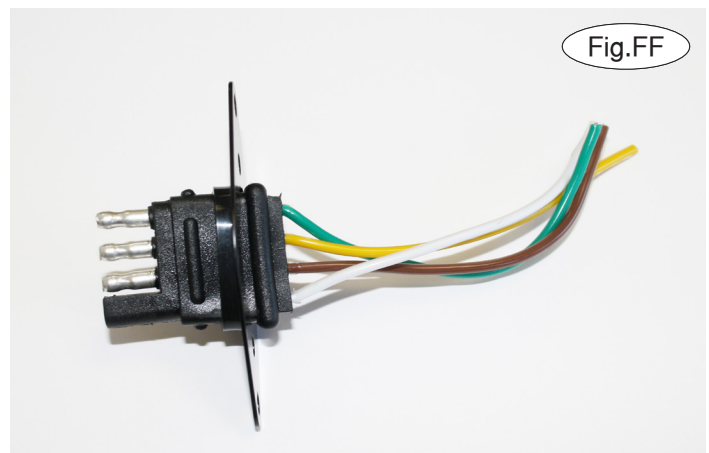

## **IMPORTANT!**

**Safety cables are required by law. When towing, connect safety cables to the safety cable tabs illustrated on the first page and in Figure EE. Make certain there is adequate slack in the cables to allow a full turning radius; otherwise, damage will result. If necessary, longer cables or cable extensions are available.**

### **Three options for attaching the wiring plug to the main receiver brace**

**For six-wire plugs:** use the two supplied  $\frac{3}{4}$ " self-tapping screws to attach the electrical plug directly to the rods on the front of the main receiver brace.

**For four-wire round plugs:** attach to the plug mounting plate and then use the two supplied  $\frac{3}{4}$ " self-tapping screws to attach the mounting plate to the rods on the front of the main receiver brace.

**For four-wire flat plugs:** place the plug through the mounting plug plate, and then secure it using the supplied zip tie on the front of the plug (Fig.FF). Use the two supplied  $\frac{3}{4}$ " self-tapping screws to attach the mounting plate to the rods on the front of the main receiver brace.



# BASEPLATE KIT INSTALLATION INSTRUCTIONS

**KIT# 524453-4**

12/28/17  
KS

ROADMASTER, Inc. 6110 NE 127th Ave. Vancouver, WA 98682 360-896-0407 fax 360-735-9300 www.roadmasterinc.com

## BOLT TORQUE REQUIREMENTS

Note: The torque values represented below are intended as general guidelines. Torque requirements for specific applications may vary. Roadmaster does not warrant this information to be accurate for all applications and disclaims all liability for any claims or damages which may result from its use.

### STANDARD BOLTS

Thread Size	Grade	Torque
5/16.....	5.....	13 ft./lb.
3/8.....	5.....	23 ft./lb.
7/16.....	5.....	37 ft./lb.
1/2.....	5.....	56 ft./lb.
5/8.....	5.....	150 ft./lb.

### METRIC BOLTS

Thread Size	Grade	Plated / Unplated
8mm-1.0.....	8.8.....	20 ft./lb. 18 ft./lb.
8mm-1.25.....	8.8.....	19 ft./lb. 18 ft./lb.
10mm-1.25.....	8.8.....	38 ft./lb. 36 ft./lb.
10mm-1.5.....	8.8.....	37 ft./lb. 35 ft./lb.

### METRIC BOLTS

Thread Size	Grade	Plated / Unplated
12mm-1.25.....	8.8.....	70 ft./lb. 65 ft./lb.
12mm-1.5.....	8.8.....	66 ft./lb. 61 ft./lb.
12mm-1.75.....	8.8.....	65 ft./lb. 60 ft./lb.
14mm-2.0.....	8.8.....	104 ft./lb. 97 ft./lb.

All illustrations and specifications contained herein are based on the latest information available at the time of publication approval. ROADMASTER, INC. reserves the right to make changes at any time without notice in material, specification and models or to discontinue models.