



BASEPLATE KIT INSTALLATION INSTRUCTIONS

KIT# 524470-5

12/25
RS

ROADMASTER, Inc.

6110 NE 127th Ave.

Vancouver, WA 98682

360-896-0407

www.RoadmasterInc.com

Second person to assist
T30 Torx driver
7, 10, 13 and 15mm sockets
5/16", 3/8" and 3/4" sockets
Ratchets

What You'll Need

3/4" wrench
11mm wrench
Flathead screwdriver

Permanent marker
Panel tool
Reciprocating saw
Torque wrench
Threadlocker Red or Blue

Important
Note: This baseplate will not accommodate the Guardian rock shield, some models of the Tow Defender, or any StowMaster All Terrain tow bar.

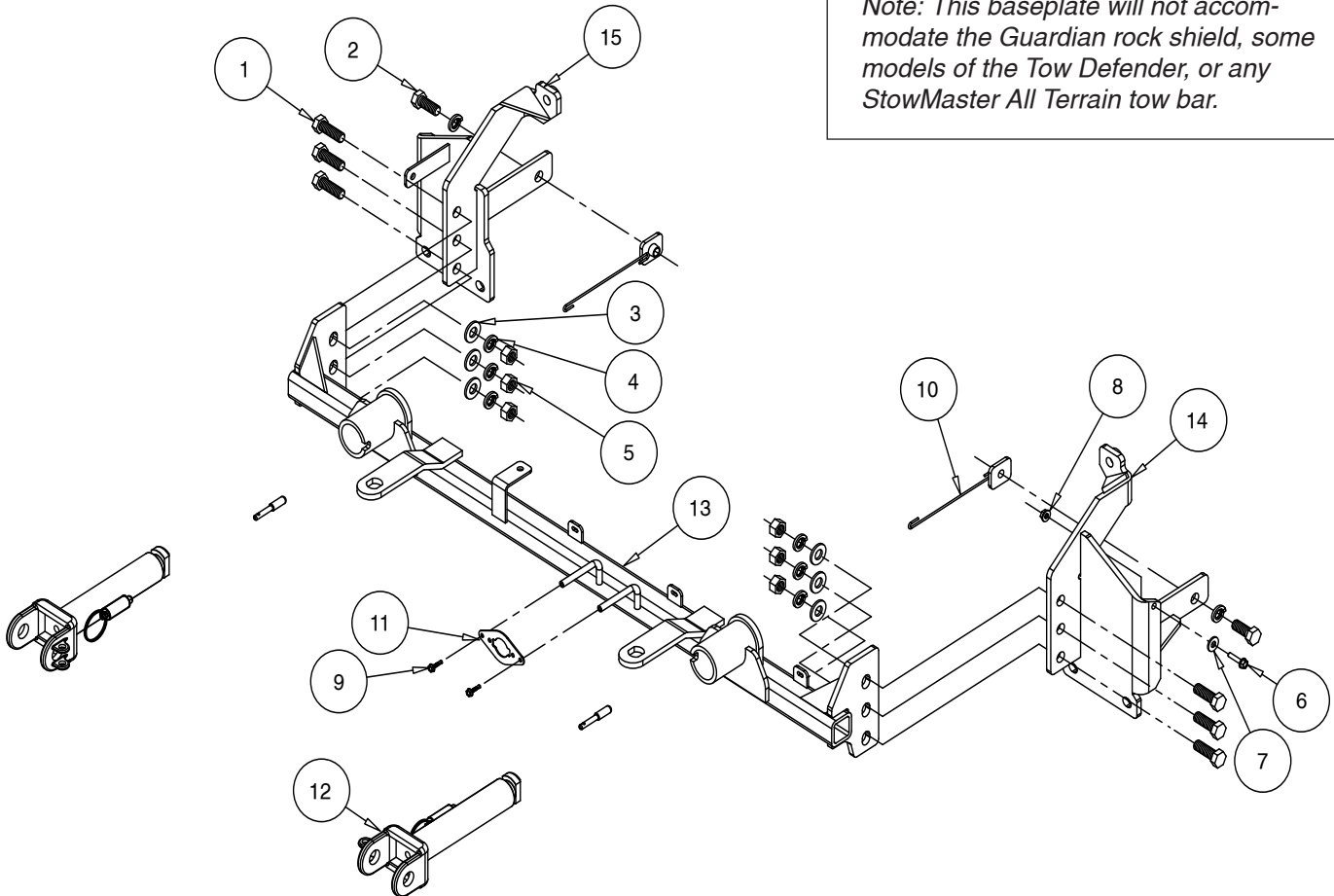

ITEM	QTY	NAME	MATERIAL
1	6	1/2" x 1 1/2" BOLT	350095-00
2	2	1/2" x 1 1/4" BOLT	350094-00
3	6	1/2" SAE WASHER	350308-20
4	8	1/2" LOCK WASHER	350309-00
5	6	1/2" HEX NUT	350258-00
6	1	1/4" x 1" WHIZ BOLT	350400-20
7	1	1/4" FLAT WASHER	350300-00
8	1	1/4" WHIZ NUT	350251-20
9	2	#10 x 3/4" SELF DRILLING SCREW	350247-35
10	2	1 1/4" x 1 1/2" THREADED BACKING PLATE W/ 6" ROD	C002077
11	1	WIRE PLUG PLATE	A003801
12	2	ARM	C002383
13	1	MAIN RECEIVER	C003661
14	1	DRIVER SIDE BRACE	C003514
15	1	PASSENGER SIDE BRACE	C003515



BASEPLATE KIT INSTALLATION INSTRUCTIONS

KIT# 524470-5

12/25
RS

ROADMASTER, Inc.

6110 NE 127th Ave.

Vancouver, WA 98682

360-896-0407

www.RoadmasterInc.com

This is one of our direct-connect baseplates, which allows the visible front portion of the baseplate to be easily removed from the front of the vehicle (Fig.A and Fig.B).

The kit mounts to the frame of the vehicle, and consists of two side-specific braces, a cross-bar, two removable front braces, and a hardware pack.

Before starting the installation, lay out the kit components in order, as they will be used. This will give you a visual idea of how the components work, and will also confirm that everything is present and accounted for.



IMPORTANT: All baseplates **must** be assembled with all the bolts left loose for final adjustment and positioning (before tightening) unless otherwise instructed. All bolts **must** be torqued for proper strength. If more than one bolt is used per fastening point, the diagram may only show one. Use flat washers over all slotted holes and lock washers on all fasteners.

WARNING

Failure to heed these warnings or follow the installation instructions may result in a voided warranty, loss of towed vehicle, personal injury or death.

- Do not weld or modify this baseplate or its components. Welding or modification will void the warranty.
- Do not use this document as a basis to design/fabricate a baseplate, as it may not show all parts or structural components.
- We strongly recommend professional installation.
- If the towed vehicle has been in an accident, it must be properly repaired before attaching the baseplate. Do not install the baseplate if any structural frame damage is found.
- The installer must use all bolts and parts supplied. If running changes were made by the vehicle manufacturer after this kit was designed, some bolts or other fasteners may no longer be the correct size. It is the installer's responsibility to verify this kit is securely fastened to the vehicle.
- Use Loctite® Red on all bolts used to secure this baseplate. Torque all bolts to the specifications found at the end of these instructions. Do not over-torque the bolts or failure may occur.
- The installer must inspect the baseplate to ensure adequate clearance, particularly around hoses, air conditioner lines, radiators, etc. or non-warranty failure may result.
- Roadmaster manufactures many styles of baseplates. If your baseplate has removable arms, they must be removed before driving the vehicle, unless the arms can be pinned or padlocked in place. If not secured, the arms could vibrate out.
- Some motorhome chassis have such a tight turning radius that you can damage your motorhome, towed vehicle, tow bar or baseplate while turning sharply. Before getting on the road, test your turning radius in an empty parking lot. Turning too sharply could result in non-warranty damage to your towing system, motorhome and/or towed vehicle.
- Do not back up with the towed vehicle attached or non-warranty damage will occur to your towing system or vehicles.
- The safety cables must connect the towing vehicle to the towed vehicle frame to frame, with the cables crossed, with enough slack for sharp turns. See cable instructions for proper routing. Failure to do so will result in non-warranty damage and/or the loss of the towed vehicle.
- This kit is designed for use with ROADMASTER tow bars and ROADMASTER adapters only. Using this kit with other brands, without an approved ROADMASTER adapter, may result in non-warranty damage or injury.
- Receiver extensions and out-of-level towing situations of 3 inches or more. This can cause the system to swing much higher and lower, causing excessive strain on the tow bar, baseplate and frame. That can cause the towing system to fail, causing property damage, personal injury or even death. If you must use a receiver extension or drop hitch to tow, it will reduce your receiver's weight capacity by 1/3 to avoid damaging your system. Never use more than one extension and/or drop hitch, as this will void your warranty.
- Every 3,000 miles, the owner must inspect all mounting points for cracks or fatigue, and check the fasteners for proper torque, according to the bolt torque requirements chart on the last page of these instructions.
- The owner must follow the vehicle manufacturer's instructions to prepare the vehicle for towing. Failure to do so may cause severe damage to the vehicle.
- This baseplate is only warranted for the original installation. Installing a used baseplate on another vehicle is not recommended and will void the warranty.



BASEPLATE KIT INSTALLATION INSTRUCTIONS

KIT# 524470-5

12/25
RS

ROADMASTER, Inc.

6110 NE 127th Ave.

Vancouver, WA 98682

360-896-0407

www.RoadmasterInc.com

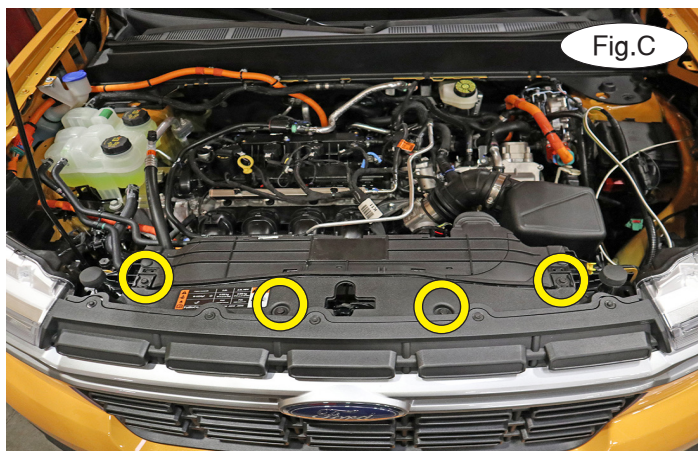

Important: Please use all supplied bolts and parts and read all instructions carefully before beginning this installation. The majority of questions you may have can be answered within the text, and proper installation will ensure safe and secure travel.

1. Remove four 10mm screws attaching the top of the fascia to the core support (Fig.C).
2. Starting on the driver's side, turn the wheel inward and remove six plastic fasteners and three 7mm screws attaching the fender liner to the fascia (Fig.D).

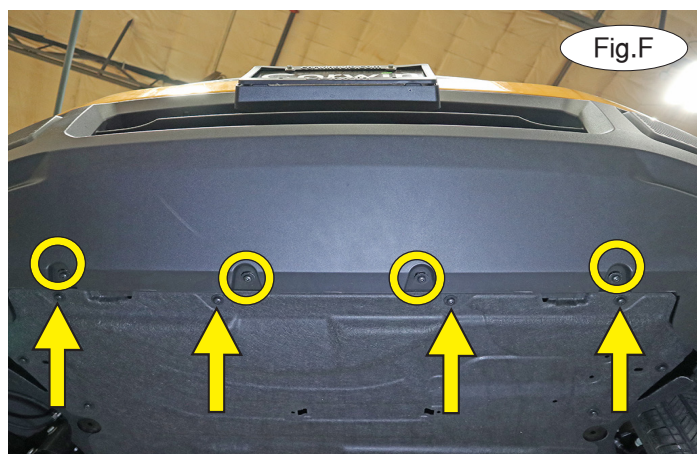
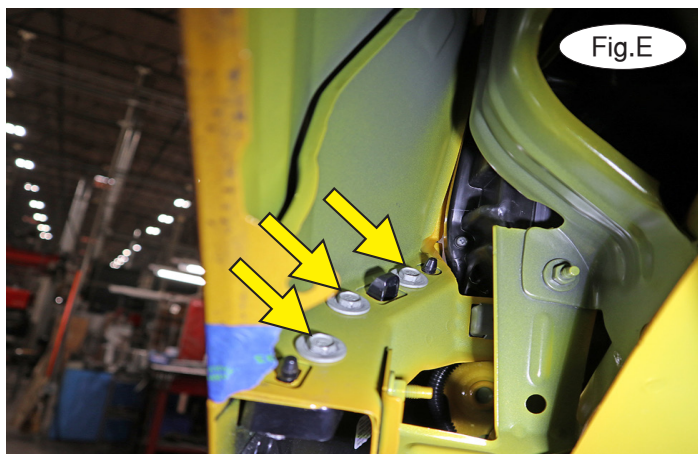

3. Peel back the fender line and remove three 10mm bolts attaching the fascia seam to the fender (Fig.E).
4. Repeat steps 2 and 3 for the passenger side.
5. Remove eight T30 torx screws attaching the bottom of the fascia to the subframe (Fig.F).
6. On each side, pull down on the corner of the fascia to separate it at the seam (Fig.G). *Note:* You will need to pull with force to achieve this but you must use care to avoid breaking the retaining clips. Leave the fascia loose at this point.

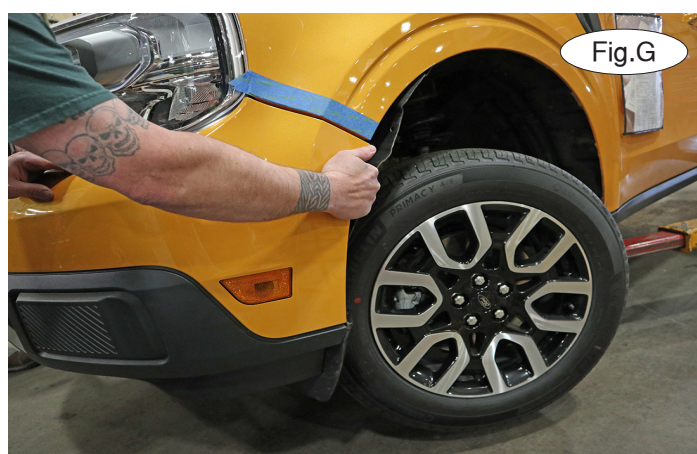

All illustrations and specifications contained herein are based on the latest information available at the time of publication approval. ROADMASTER, INC. reserves the right to make changes at any time without notice in material, specification and models or to discontinue models.



BASEPLATE KIT INSTALLATION INSTRUCTIONS

KIT# 524470-5

12/25
RS

ROADMASTER, Inc.

6110 NE 127th Ave.

Vancouver, WA 98682

360-896-0407

www.RoadmasterInc.com

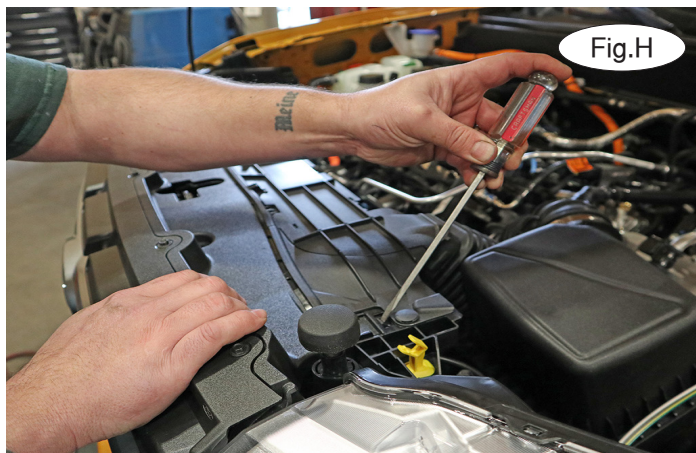

7. With the assistance of another person, use a flathead screwdriver to release the retaining clip on each side (Fig.H). Once it is loose, release three retaining clips on each headlight bezel (Fig.I) and then very carefully pull out to remove the fascia. Disconnect the passenger side wiring harness and set the fascia aside for now.



8. If the vehicle is equipped with a Pedestrian Alert Device (PAD), remove one 8mm screw attaching it to the lower radiator housing (Fig.J). Unplug it and set it aside to be reinstalled later (Fig.K).

9. On each side, remove one plastic fastener and release the clips around the perimeter attaching the air dam to the lower shutter housing (Fig.L). *Note:* You will need to pry up on the upper clips (Fig.M) and push down on the lower clips. Set the air dam aside for now. It will be trimmed and reinstalled later in these instructions.

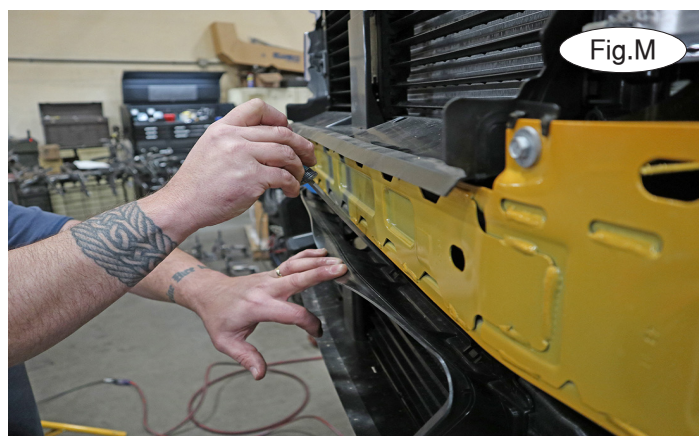



BASEPLATE KIT INSTALLATION INSTRUCTIONS

KIT# 524470-5

12/25
RS

ROADMASTER, Inc.

6110 NE 127th Ave.

Vancouver, WA 98682

360-896-0407

www.RoadmasterInc.com

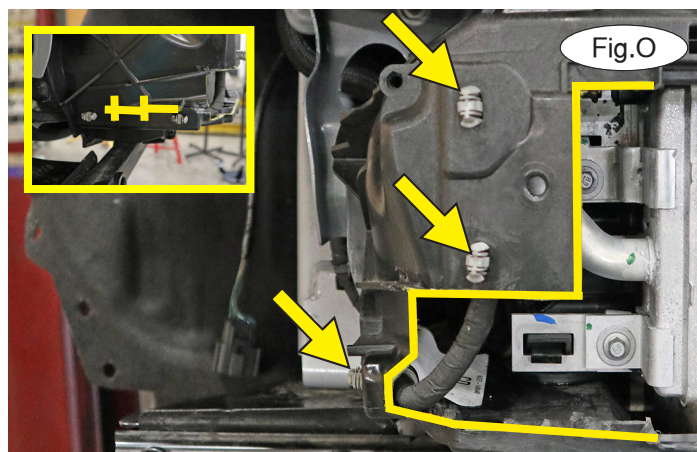

10. To allow clearance for the main receiver brace, you will need to extensively trim the Active Air Shutter system. Start by trimming off the ladder system as shown in Figure N. Then, pull out to release it from the shutters.

11. On the passenger side only, use a flathead screwdriver to punch the wiring retainers back into the housing (Fig.O – arrows). Now, use the yellow lines as references for trimming the outer shutter mounts on each side of the vehicle (Fig.O, Fig.O – inset, Fig.P and Fig.P – inset). *Note:* Use caution when trimming due to proximity to engine components. Then, pull away from the center to remove all shutter ribs and reattach the passenger side wiring harnesses.

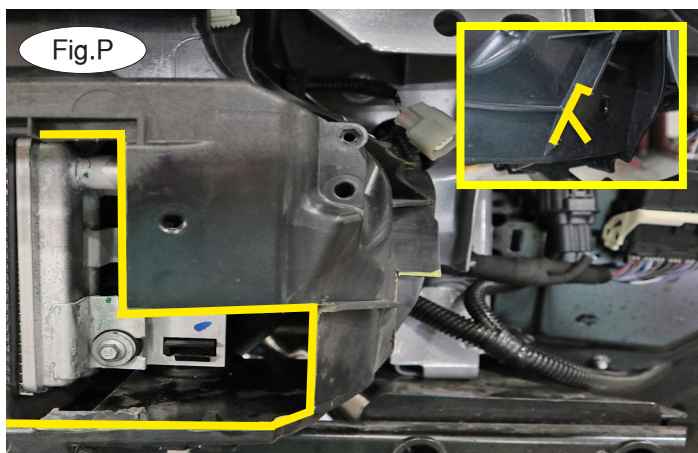

12. Trim out the center section of the shutter system as shown in Figure Q.

13. Reattach the air dam by reversing step 9. Then, trim it as shown on each side and in the center (Fig.R).

14. Starting on the driver's side, remove two 13mm bolts and one 15mm nut attaching the lower subframe brace to the subframe and bumper core support (Fig.S).

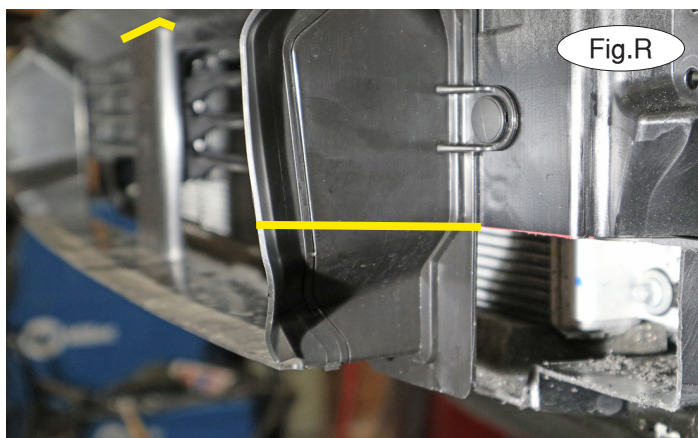



BASEPLATE KIT INSTALLATION INSTRUCTIONS

KIT# 524470-5

12/25
RS

ROADMASTER, Inc.

6110 NE 127th Ave.

Vancouver, WA 98682

360-896-0407

www.RoadmasterInc.com

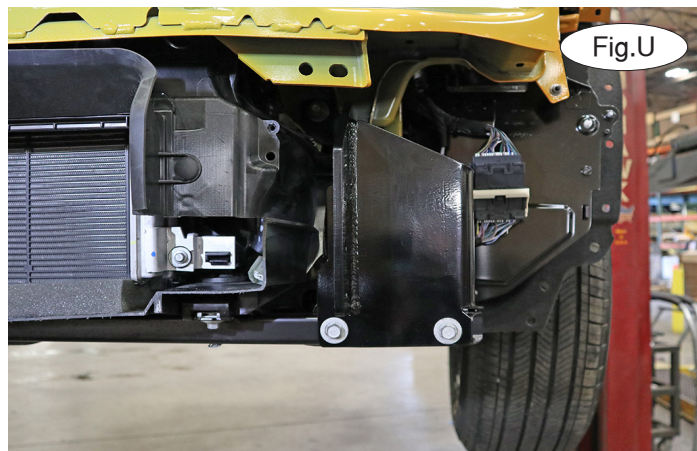
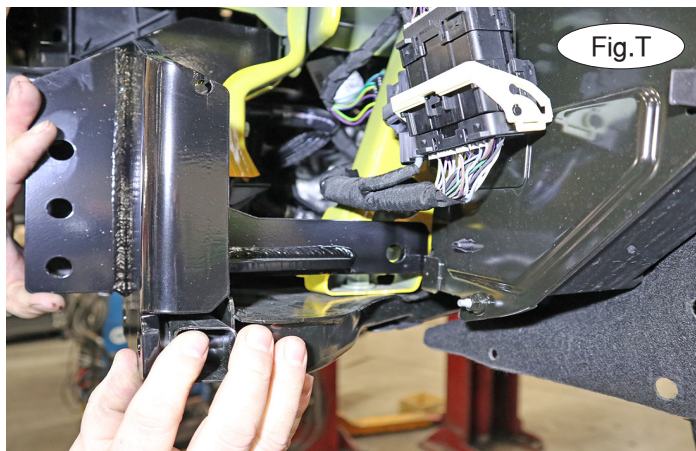

15. Then, using the drawing on page 1 as a reference, locate the driver's-side specific brace and place the upper mount with the welded spacer over the exposed mounts (Fig.T). Place Threadlocker on the factory nut and two factory 13mm bolts removed in the previous step and then replace them (Fig.U). Tighten the hardware to the factory specifications.

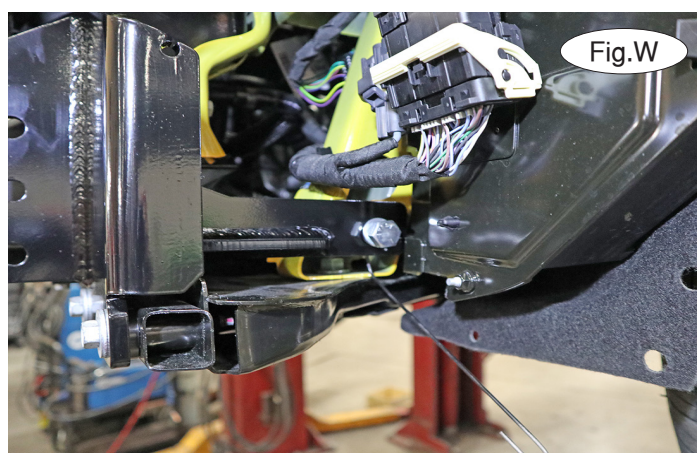

16. Insert a 3/16" x 1 1/4" x 1 1/2" threaded backing plate with rod into the access hole (Fig.V). *Note:* Bend it as shown. Then, place a 1/2" lock washer and Threadlocker over a 1/2" x 1 1/4" bolt and pass the bolt through the rearmost mount of the baseplate and into the backing plate (Fig.W). Tighten the bolts to the torque specifications found at the end of these instructions. Snap off or bend rod back out of the way.

17. Repeat steps 11 through 15 for the passenger side of the vehicle.

18. Remove the indicated nub on the PAD (Fig.X) and then plug in the PAD and place 1/4" flat washer over a 1/4" x 1" whiz bolt. Bolt through the the mount and the driver's side-specific brace as shown and finish with a 1/4" whiz nut (Fig.Y).

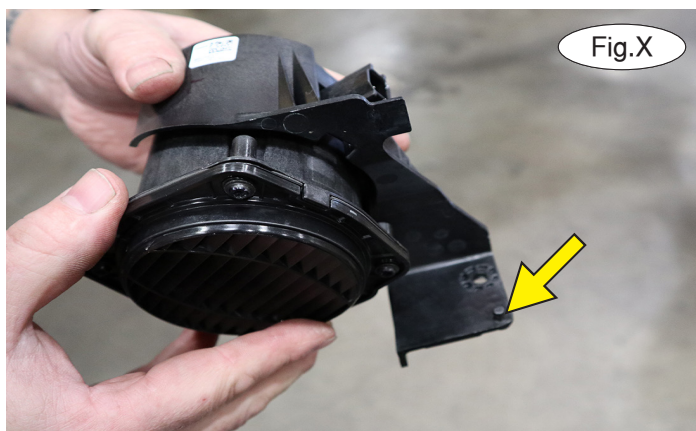



BASEPLATE KIT INSTALLATION INSTRUCTIONS

KIT# 524470-5

12/25
RS

ROADMASTER, Inc.

6110 NE 127th Ave.

Vancouver, WA 98682

360-896-0407

www.RoadmasterInc.com

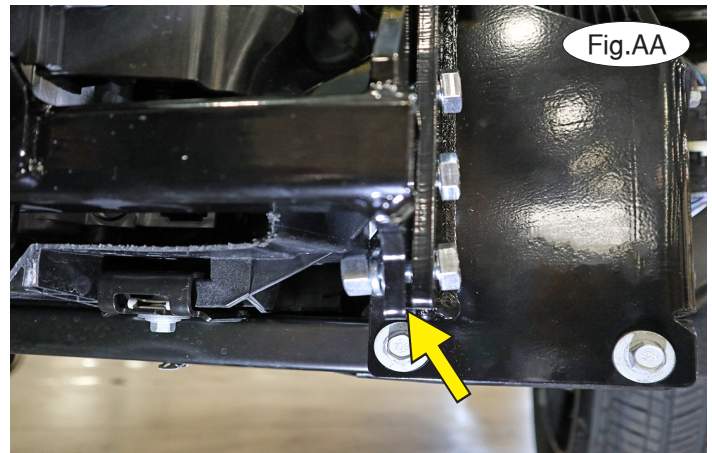

19. Refer to the drawing on page 1 to verify the correct orientation of the crossbar. Then, with the help of a second person, place the crossbar between the two side-specific braces and verify clearance on each side. On each side, bolt it into place using the supplied 1/2" x 1 1/2" bolts (apply Threadlocker first). Finish each bolt with a 1/2" flat washer, lock washer and nut (Fig.Z). *Note:* Clearances are very tight here. You may need to hold the nut and thread into it. Also, if after installing the crossbar any part of the shutter housing is still in the way, trim it off.

20. On each side, push up on the crossbar until the bottom of it is flush with the bottom of the side-specific brace (Fig. AA). Then, tighten the bolts.

21. Reinstall the fascia by reversing steps 1 through 7.

22. On each side, insert the removable front arm into the front receiver 90 degrees from its final towing position, depressing the spring-loaded pin against the receiver. Twist back 90 degrees until the spring-loaded pin snaps into place in the notch on the receiver, locking the arm into place in its final towing position. **Please note: It is the owner's responsibility to ensure the locking of the pins before towing. Otherwise, failure of the towing system will result.**

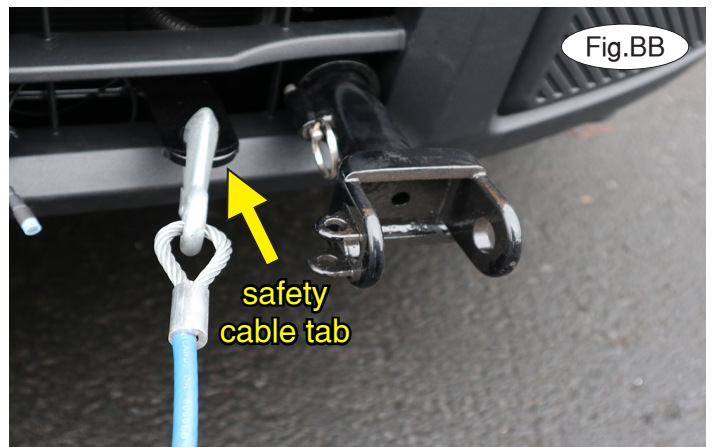

IMPORTANT!

Safety cables are required by law. When towing, connect safety cables to the safety cable tabs illustrated on the separate insert with the drawing and parts list and in Figure BB. Make certain there is adequate slack in the cables to allow a full turning radius; otherwise, damage will result. If necessary, longer cables or cable extensions are available.

BOLT TORQUE REQUIREMENTS

Note: The torque values represented below are intended as general guidelines. Torque requirements for specific applications may vary. Roadmaster does not warrant this information to be accurate for all applications and disclaims all liability for any claims or damages which may result from its use.

STANDARD BOLTS

Thread Size	Grade	Torque
5/16-18	.5	13 ft./lb.
3/8-16	.5	23 ft./lb.
7/16-14	.5	37 ft./lb.
1/2-13	.5	57 ft./lb.
5/8-11	.5	112 ft./lb.

METRIC BOLTS

Thread Size	Grade	Torque
6mm-1.0	.8.8	.6 ft./lb.
8mm-1.0	.8.8	.18 ft./lb.
8mm-1.25	.8.8	.16 ft./lb.
10mm-1.25	.8.8	.36 ft./lb.
10mm-1.5	.8.8	.31 ft./lb.

METRIC BOLTS

Thread Size	Grade	Torque
12mm-1.25	.8.8	.64 ft./lb.
12mm-1.5	.8.8	.60 ft./lb.
12mm-1.75	.8.8	.55 ft./lb.
14mm-2.0	.8.8	.88 ft./lb.

All illustrations and specifications contained herein are based on the latest information available at the time of publication approval. ROADMASTER, INC. reserves the right to make changes at any time without notice in material, specification and models or to discontinue models.