



BASEPLATE KIT INSTALLATION INSTRUCTIONS

KIT# 524480-5

12/25
RS

ROADMASTER, Inc.

6110 NE 127th Ave.

Vancouver, WA 98682

360-896-0407

www.RoadmasterInc.com

What You'll Need

A second person to help
Panel tool
Reciprocating Saw
T30 Torx Driver

Ratchet
3/4" & 11 mm Wrenches
7, 10, 13, & 15 mm Sockets
3/4" Sockets

Flathead Screwdriver
Torque wrench
Threadlocker
Marker or paint pen

Need Help? Call Toll-Free
 **1-800-669-9690**

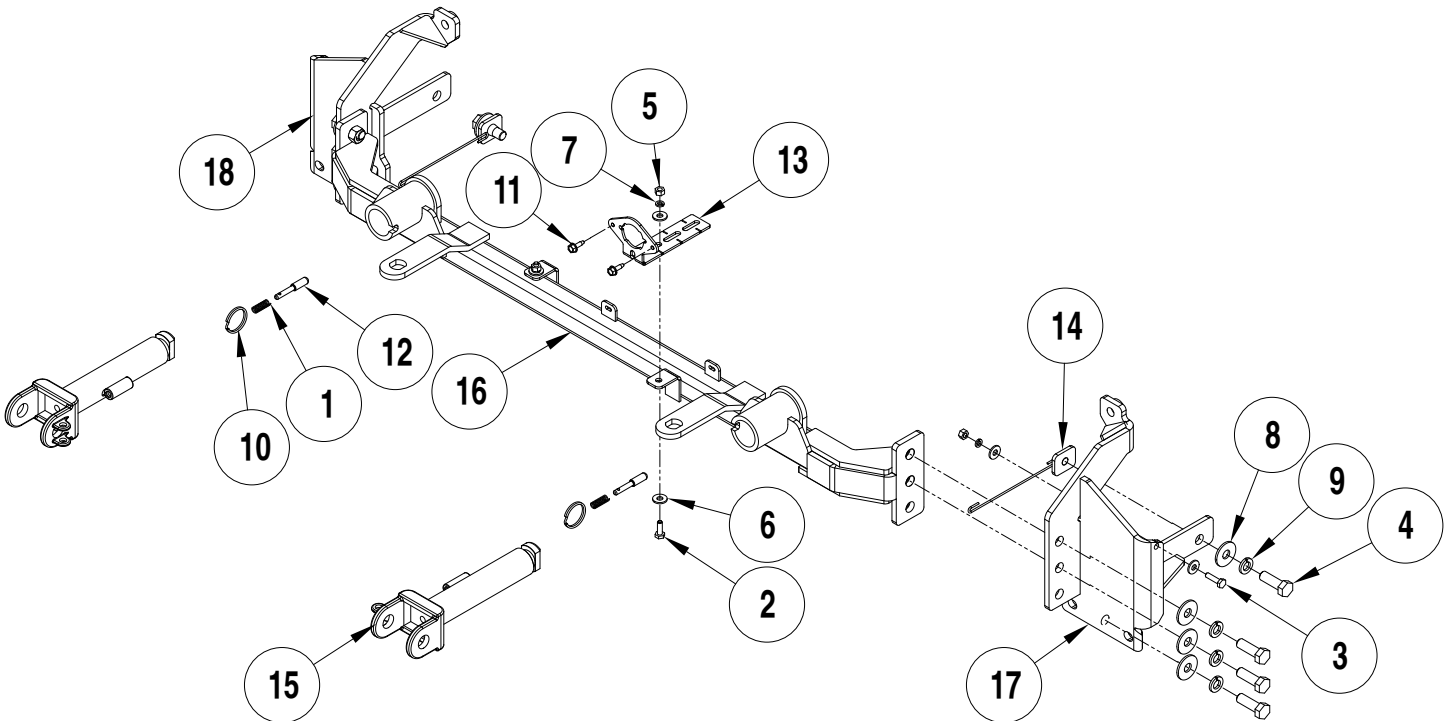

Important:

*This baseplate is made to accommodate the Guardian XL (#4100).
It will not accommodate the Guardian (#4000), some models of the
Tow Defender, or StowMaster tow bars.*

ITEM	QTY.	DESCRIPTION	PART
1	2	SPRING	200146-00
2	2	1/4" x 3/4" BOLT	350003-01
3	1	1/4" x 1" BOLT	350005-00
4	8	1/2" x 1 1/2" BOLT	350095-00
5	3	1/4" HEX NUT	350250-00
6	6	1/4" FLAT WASHER	350300-00
7	3	1/4" LOCK WASHER	350301-00
8	8	1/2" FLAT WASHER	350308-00
9	8	1/2" LOCK WASHER	350309-00
10	2	RING	350520-00
11	2	1/4" x 3/4" SELF DRILLING SCREW	357250-00
12	2	LOCK PIN	A000008
13	1	WIRE PLUG PLATE	A006808
14	2	1 1/4" x 1 1/2" THREADED BACKING PLATE	C002077
15	2	ARM	C002383
16	1	MAIN RECEIVER	C003877
17	1	DRIVER SIDE BRACE	C003878
18	1	PASSENGER SIDE BRACE	C003879



BASEPLATE KIT INSTALLATION INSTRUCTIONS

KIT# 524480-5

12/25
RS

ROADMASTER, Inc.

6110 NE 127th Ave.

Vancouver, WA 98682

360-896-0407

www.RoadmasterInc.com

IMPORTANT: All baseplates **must** be assembled with all the bolts left loose for final adjustment and positioning (before tightening) unless otherwise instructed. All bolts **must** be torqued for proper strength. If more than one bolt is used per fastening point, the diagram may only show one. Use flat washers over all slotted holes and lock washers on all fasteners.

WARNING

Failure to heed these warnings or follow the installation instructions may result in a voided warranty, loss of towed vehicle, personal injury or death.

- Do not weld or modify this baseplate or its components. Welding or modification will void the warranty.
- Do not use this document as a basis to design/fabricate a baseplate, as it may not show all parts or structural components.
- We strongly recommend professional installation.
- If the towed vehicle has been in an accident, it must be properly repaired before attaching the baseplate. Do not install the baseplate if any structural frame damage is found.
- The installer must use all bolts and parts supplied. If running changes were made by the vehicle manufacturer after this kit was designed, some bolts or other fasteners may no longer be the correct size. It is the installer's responsibility to verify this kit is securely fastened to the vehicle.
- Use Threadlocker Red on all bolts used to secure this baseplate. Torque all bolts to the specifications found at the end of these instructions. Do not over-torque the bolts or failure may occur.
- The installer must inspect the baseplate to ensure adequate clearance, particularly around hoses, air conditioner lines, radiators, etc. or non-warranty failure may result.
- Roadmaster manufactures many styles of baseplates. If your baseplate has removable arms, they must be removed before driving the vehicle, unless the arms can be pinned or padlocked in place. If not secured, the arms could vibrate out.
- Some motorhome chassis have such a tight turning radius that you can damage your motorhome, towed vehicle, tow bar or baseplate while turning sharply. Before getting on the road, test your turning radius in an empty parking lot. Turning too sharply could

result in non-warranty damage to your towing system, motorhome and/or towed vehicle.

- Do not back up with the towed vehicle attached or non-warranty damage will occur to your towing system or vehicles.
- The safety cables must connect the towing vehicle to the towed vehicle frame to frame, with the cables crossed, with enough slack for sharp turns. See cable instructions for proper routing. Failure to do so will result in non-warranty damage and/or the loss of the towed vehicle.
- This kit is designed for use with ROADMASTER tow bars and ROADMASTER adapters only. Using this kit with other brands, without an approved ROADMASTER adapter, may result in non-warranty damage or injury.
- Receiver extensions and out-of-level towing situations of 3" or more can cause the system to swing much higher and lower, causing excessive strain on the tow bar, baseplate and frame. That can cause the towing system to fail, causing property damage, personal injury or even death. If you must use a receiver extension or drop hitch to tow, it will reduce your receiver's the towing system's capacity by 1/3 to avoid damaging your system. Never use more than one extension and/or drop hitch, as this will void your warranty.
- Every 3,000 miles, the owner must inspect all mounting points for cracks or fatigue, and check the fasteners for proper torque, according to the bolt torque requirements chart on the last page of these instructions.
- The owner must check and follow the vehicle manufacturer's instructions to prepare the vehicle for towing. Failure to do so may cause severe damage to the vehicle.
- This baseplate is only warranted for the original installation. Installing a used baseplate on another vehicle is not recommended and will void the warranty.

About this kit:

This is one of our direct connect-style series, which allows the visible front portion of the baseplate to be easily removed from the front of the vehicle (Fig.A and Fig.B).

Before starting the installation, lay out the kit components in order, as they will be used. This will give you a visual idea of how the components work, and will also confirm that everything is present and accounted for.

Important: All illustrations and specifications contained herein are based on the latest information available at the time of publication approval. ROADMASTER, INC. reserves the right to make changes at any time without notice in material, specification and models or to discontinue models.





BASEPLATE KIT INSTALLATION INSTRUCTIONS

KIT# 524480-5

12/25
RS

ROADMASTER, Inc.

6110 NE 127th Ave.

Vancouver, WA 98682

360-896-0407

www.RoadmasterInc.com

Important: Please use all supplied hardware and read through these instructions carefully before beginning this installation. The majority of questions you may have can be answered within the text, and proper installation will ensure safe and secure travel.

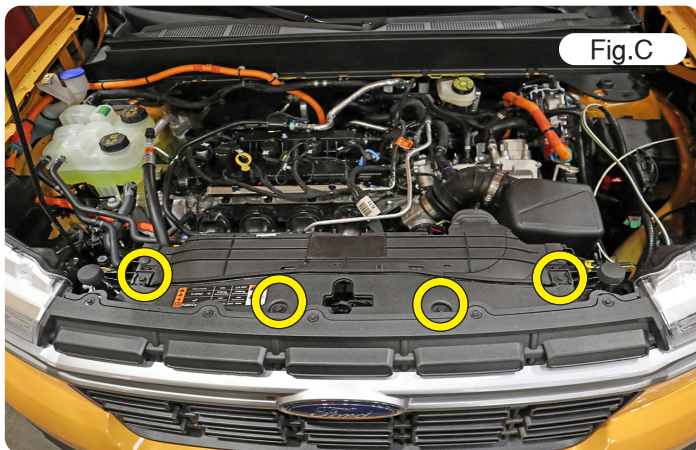

NOTE: The exact position of parts, color and trim of the vehicle in photos in these instructions may differ.

1. Remove four 10mm screws attaching the top of the fascia to the core support (Fig.C).
2. Starting on the driver's side, turn the wheel inward and remove six plastic fasteners and three 7mm screws attaching the fender liner to the fascia (Fig.D).
3. Peel back the fender liner and remove three 10mm bolts attaching the fascia seam to the fender (Fig.E). Squeeze the encircled plastic clip to quickly and easily release the fascia.

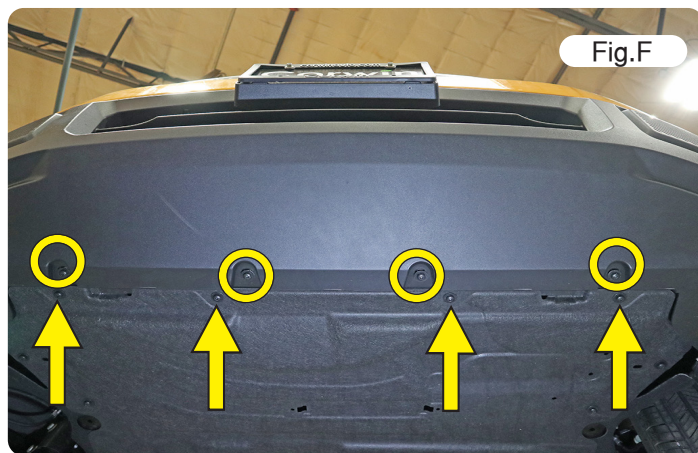

4. Repeat steps 2 and 3 for the passenger side, disconnect the wiring harness
5. Remove eight T30 torx screws attaching the bottom of the fascia to the subframe (Fig.F).
6. On each side, pull down on the corner of the fascia to separate it at the seam (Fig.G).

Note: You may need to pull with force to achieve this but you must use care to avoid breaking the retaining clips. Leave the fascia loose at this point. Releasing the clips in Fig.E should help.

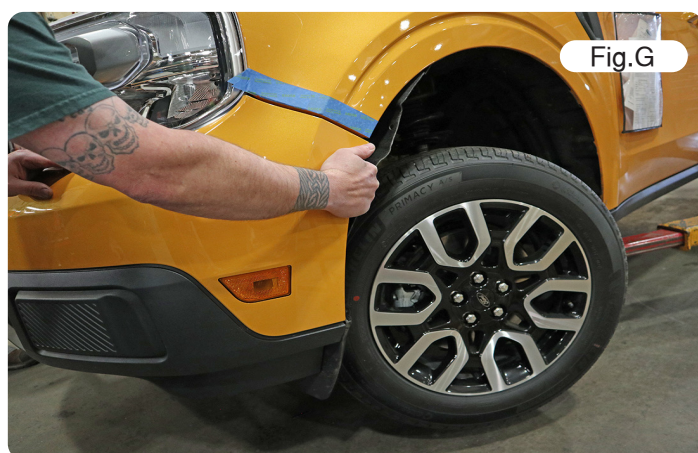

Continues on next page...



BASEPLATE KIT INSTALLATION INSTRUCTIONS

KIT# 524480-5

12/25
RS

ROADMASTER, Inc.

6110 NE 127th Ave.

Vancouver, WA 98682

360-896-0407

www.RoadmasterInc.com

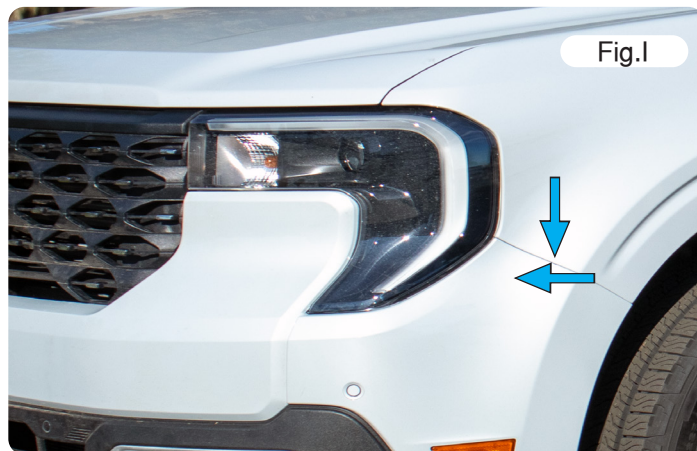
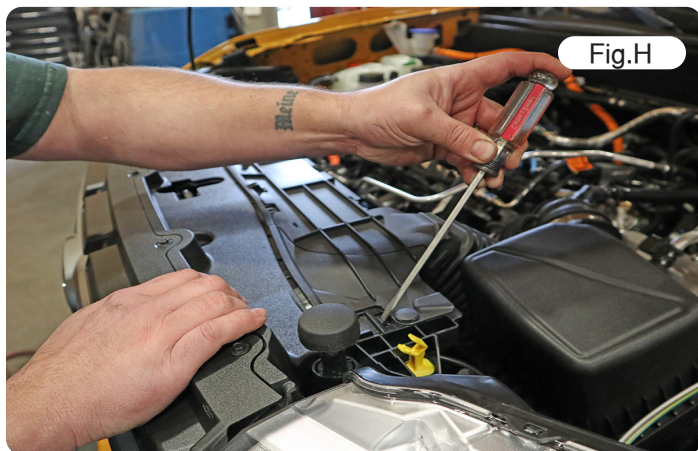

7. With the assistance of another person, use a flathead screwdriver to release the retaining clip on each side (Fig.H). Once it is loose, use a plastic tool to pry each headlight bezel (Fig.I) and then very carefully push down and pull out to remove the fascia and set the aside for now.

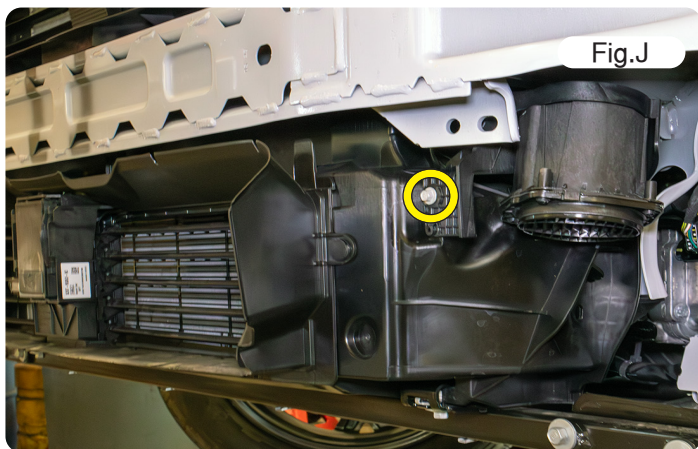

8. If the vehicle is equipped with a Pedestrian Alert Device (PAD), remove one 8mm screw attaching it to the lower radiator housing (Fig.J). Unplug it and, gently, set it aside to be reinstalled later (Fig.K).

9. On each side, remove one plastic fastener and release the clips around the perimeter attaching the air dam to the lower shutter housing (Fig.L). Note: You will need to pry up on the upper clips (Fig.M) and push down on the lower clips. Set the air dam aside for now. Depending on trim; it may be trimmed and reinstalled later in these instructions.

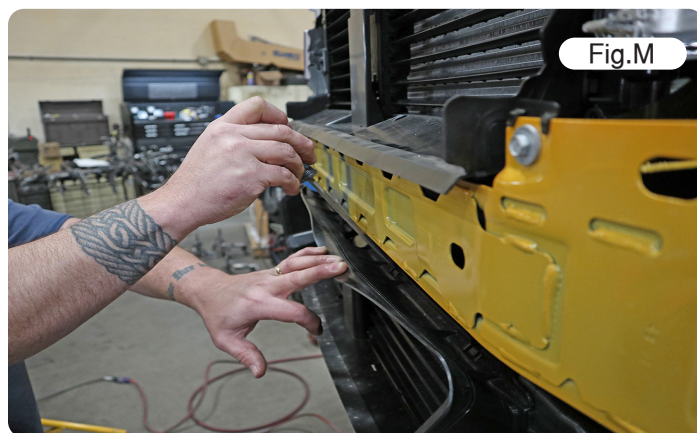
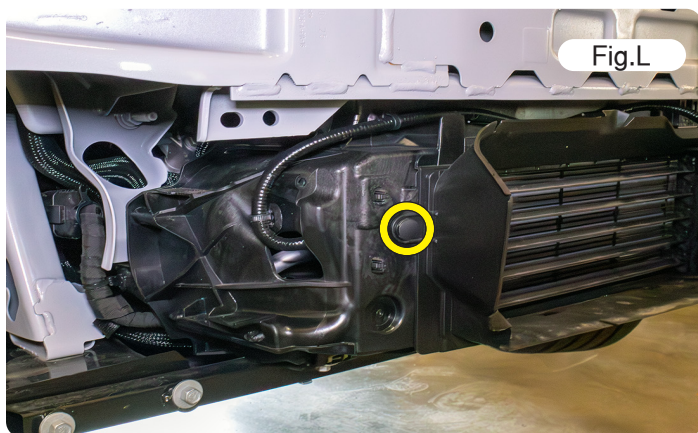



BASEPLATE KIT INSTALLATION INSTRUCTIONS

KIT# 524480-5

12/25
RS

ROADMASTER, Inc.

6110 NE 127th Ave.

Vancouver, WA 98682

360-896-0407

www.RoadmasterInc.com

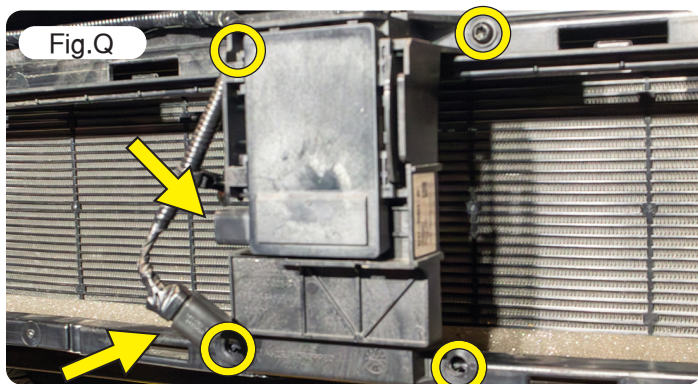

10. Uncouple the wire harness from the center active sensor (Fig.Q, Arrow) then remove the four T30 screws holding the sensor in place, depending on trim there may be adjacent plastic plugs on the top of the sensor that will need to be pried out. (Fig.Q, Circles).

WARNING: Gently handle this sensor, as dropping or mishandling the sensor may permanently damage the internal working beyond repair! Roadmaster Inc. does not take responsibility or liability for any damages.

Gently set aside the sensor and screws for now.

by trimming off the ladder system (Fig.N). Then, pull out to release it from the shutters. *Some Trims/Models have an active sensor below the ladder, use caution as to not damage such sensor.*

12. On the passenger side only, use a flathead screwdriver to punch the wiring retainers back into the housing (Fig.O, arrows). Now, use the yellow lines as references for trimming the outer shutter mounts on each side of the vehicle (Fig.O,OA, and both Insets, Fig.P and Fig.P, inset). **Note: Use caution when trimming due to proximity to engine components.**

13. Pull away from the center of the shutter to remove all shutter ribs and then reattach the passenger side wiring harnesses.

14. Depending on model and trim, the air dam may not need to be trimmed; for Lariat models, do not trim and do not reattach air dam until after installation is complete. For other models and trims; trim it as shown on each side as needed for clearance of the receiver. It may be reattached now or after install, reattach the air dam by reversing step 9.

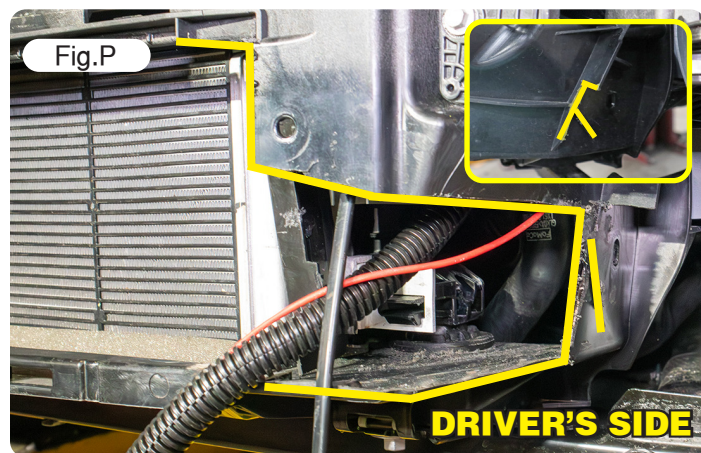
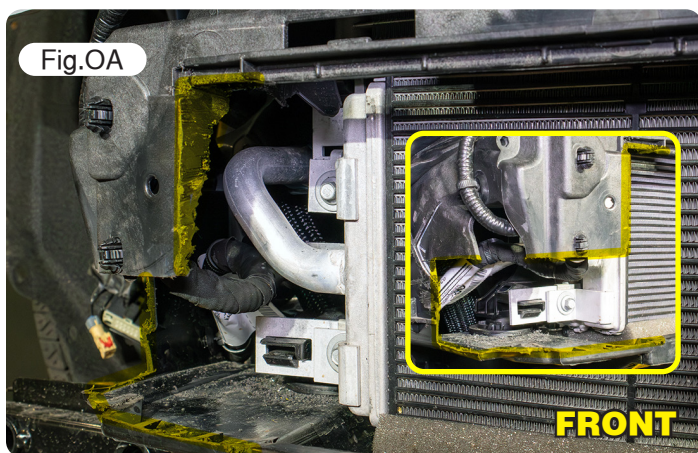
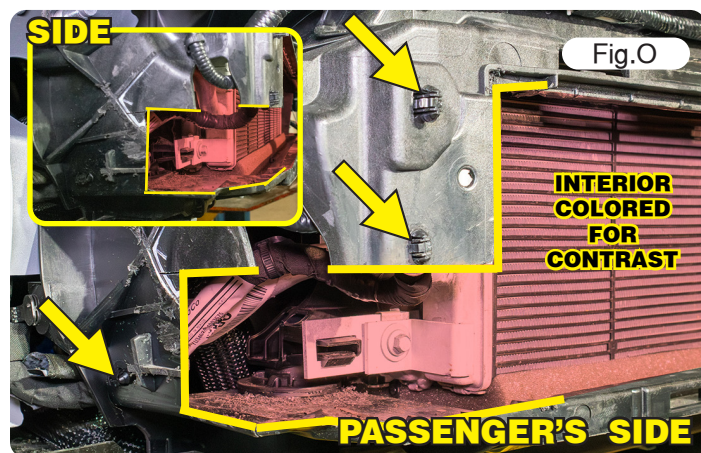



BASEPLATE KIT INSTALLATION INSTRUCTIONS

KIT# 524480-5

12/25
RS

ROADMASTER, Inc.

6110 NE 127th Ave.

Vancouver, WA 98682

360-896-0407

www.RoadmasterInc.com

15. Starting on the driver's side, remove two 13mm bolts and one 15mm nut attaching the lower subframe brace to the subframe and bumper core support (Fig.S).

16. Then, using the drawing on page 1 as a reference, locate the driver's-side specific brace and place the upper mount with the welded spacer over the exposed mounts (Fig.T). Place Threadlocker on the factory nut and two factory 13mm bolts removed in the previous step and then replace them (Fig.U). Tighten the hardware to the factory specifications.

17. Insert a 3/16" x 1 1/4" x 1 1/2" threaded backing plate with rod into the access hole (Fig.V). Bend it as shown.

18. Then, place a 1/2" lock washer, flat washer and Threadlocker over a 1/2" x 1 1/2" bolt and pass the bolt through the rear-most mount on the side you are working on and into the placed backing plate (Fig.W). Tighten the bolts to the torque specifications found at the end of these instructions. Snap off or bend rod back out of the way.

19. Repeat steps 15 through 18 for the passenger side of the vehicle.

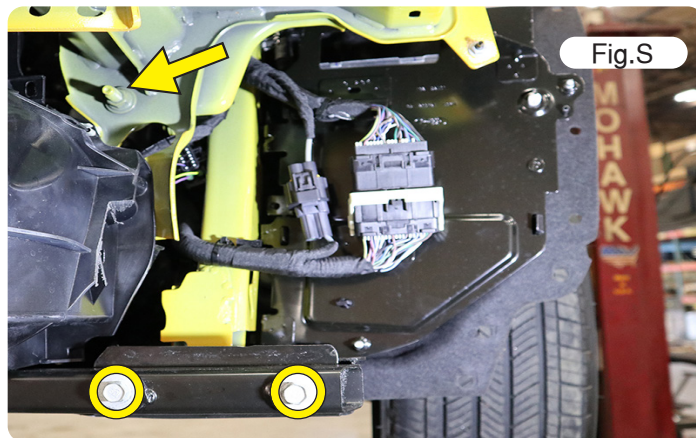

Fig.S

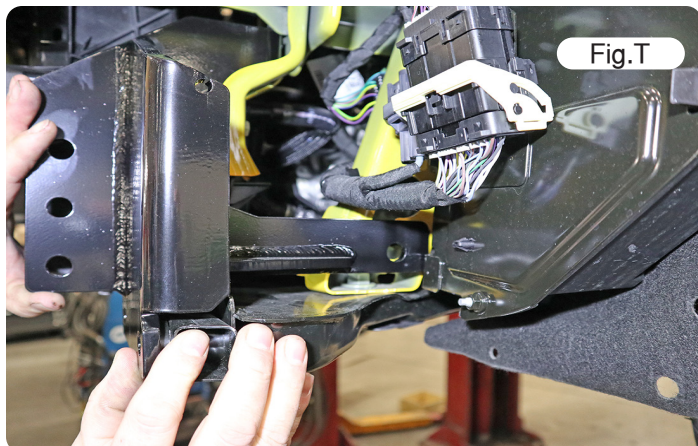

Fig.T



Fig.U

20. Remove the indicated nub on the PAD (Fig.X) and then reinstall the PAD by reversing step 8 (Fig.Y). The PAD may be installed in an alternative manner, depending on the length of the cable it may be too difficult to install back into the original positional fully; instead run the wires attaching to the PAD in front of the shutters using a self-tapping screw into the plate as indicated in Figure Y, inset.

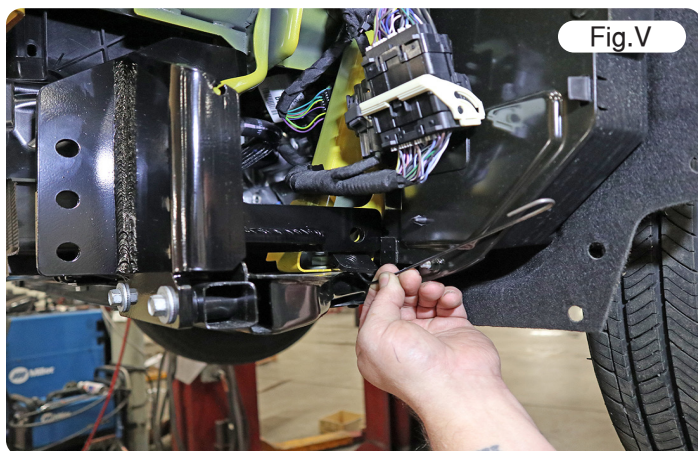

Fig.V

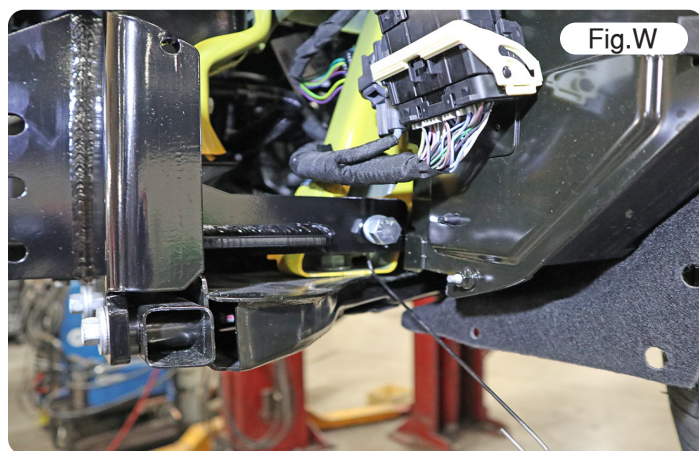

Fig.W



BASEPLATE KIT INSTALLATION INSTRUCTIONS

KIT# 524480-5

12/25
RS

ROADMASTER, Inc.

6110 NE 127th Ave.

Vancouver, WA 98682

360-896-0407

www.RoadmasterInc.com

21. Refer to the drawing on page 1 to verify the correct orientation of the main receiver. Then, with the help of a second person, place the main receiver between the two side-specific braces and verify clearance on each side. On each side, place a lockwasher, flat washer, and threadlocker onto the three supplied 1/2 x 1 1/2 bolts, place the center bolt first and leave finger tight. Then, install the two other bolts, tighten all three to specification. All three are placed into weld nuts.

Note: Clearances are very tight here. Also, if after installing the main receiver any part of the shutter housing is still in the way, trim it off.

22. On each side, push up on the main receiver until the bottom of it is flush with the bottom of the side-specific brace (Fig. AA). Then, torque the bolts; starting first with the main receiver then the side brace.

23. Reinstall the active collision sensor and the air damn.

24. Then mount the breakaway as desired, reinstall the fascia by reversing steps 1 through 7.

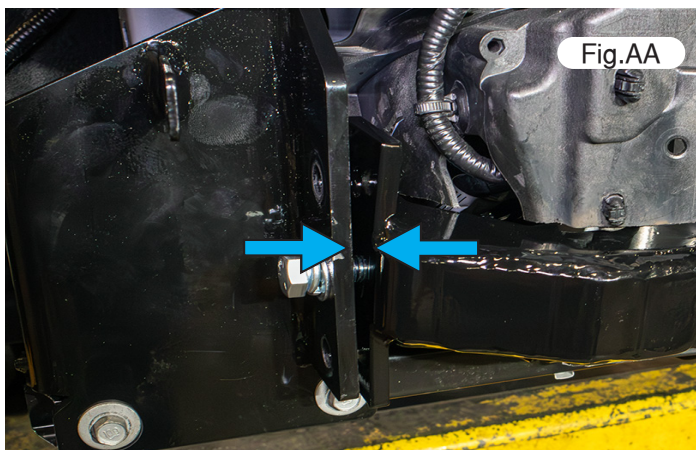
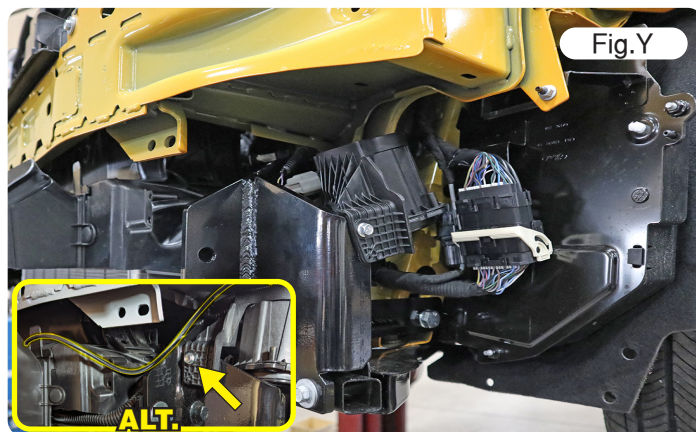
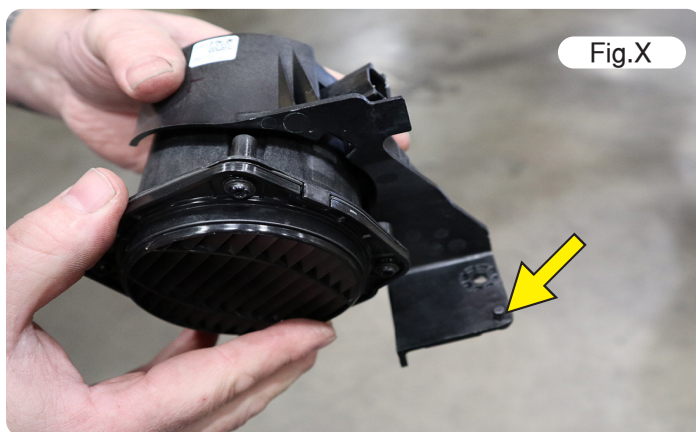

25. Bend the wireplug on the first tab and break off the rest of the tabs after the third. Install the wireplug as desired.

26. On each side, insert the removable front arm into the front receiver 90 degrees from its final towing position, depressing the spring-loaded pin against the receiver. Twist back 90 degrees until the spring-loaded pin snaps into place in the notch on the receiver, locking the arm into place in its final towing position.

Important: Please note, it is the owner's responsibility to ensure the locking of the pins before towing. Otherwise, failure of the towing system will result.



BASEPLATE KIT INSTALLATION INSTRUCTIONS

KIT# 524480-5

12/25
RS

ROADMASTER, Inc.

6110 NE 127th Ave.

Vancouver, WA 98682

360-896-0407

www.RoadmasterInc.com

IMPORTANT!

Safety cables are required by law. When towing, connect safety cables to the safety cable tabs illustrated on the separate insert with the drawing and parts list and in adjacent figure. Make certain there is adequate slack in the cables to allow a full turning radius; otherwise, damage will result. If necessary, longer cables or cable extensions are available.

WARNING!

If you do not use Threadlocker Red on all bolts in this kit and torque to the specified values, it could cause failure of the towing system.



BOLT TORQUE REQUIREMENTS

Note: The torque values represented below are intended as general guidelines. Torque requirements for specific applications may vary. Roadmaster does not warrant this information to be accurate for all applications and disclaims all liability for any claims or damages which may result from its use.

STANDARD BOLTS

Thread Size	Grade	Torque
5/16-18	5	13 ft./lb.
3/8-16	5	23 ft./lb.
7/16-14	5	37 ft./lb.
1/2-13	5	57 ft./lb.
5/8-11	5	112 ft./lb.

METRIC BOLTS

Thread Size	Grade	Torque
6mm-1.0	8.8	6 ft./lb.
8mm-1.0	8.8	18 ft./lb.
8mm-1.25	8.8	16 ft./lb.
10mm-1.25	8.8	36 ft./lb.
10mm-1.5	8.8	31 ft./lb.

METRIC BOLTS

Thread Size	Grade	Torque
12mm-1.25	8.8	64 ft./lb.
12mm-1.5	8.8	60 ft./lb.
12mm-1.75	8.8	55 ft./lb.
14mm-2.0	8.8	88 ft./lb.

Three options for attaching the wiring plug to the main receiver brace:

For six-wire plugs: Use the two supplied 3/4" self-tapping screws to attach the electrical plug directly to the rods on the front of the main receiver brace.

For four-wire round plugs: Attach to the plug mounting plate and then use the two supplied 3/4" self-tapping screws to attach the mounting plate to the rods on the front of the main receiver brace.

For four-wire flat plugs: Place the plug through the mounting plug plate, and then secure it using the supplied zip tie on the front of the plug (Fig.ZZ). Use the two supplied 3/4" self-tapping screws to attach the mounting plate to the rods on the front of the main receiver brace.

