



1-800-669-9690

# BRAKE LIGHT SWITCH BRACKET AND WIRING KIT INSTALLATION INSTRUCTIONS #751500



#6057-00 08-19

ALL SPECIFICATIONS ARE SUBJECT TO CHANGE WITHOUT NOTICE

ROADMASTER, Inc. 6110 NE 127th Ave. Vancouver, WA 98682 360-896-0407 fax 360-735-9300 www.roadmasterinc.com

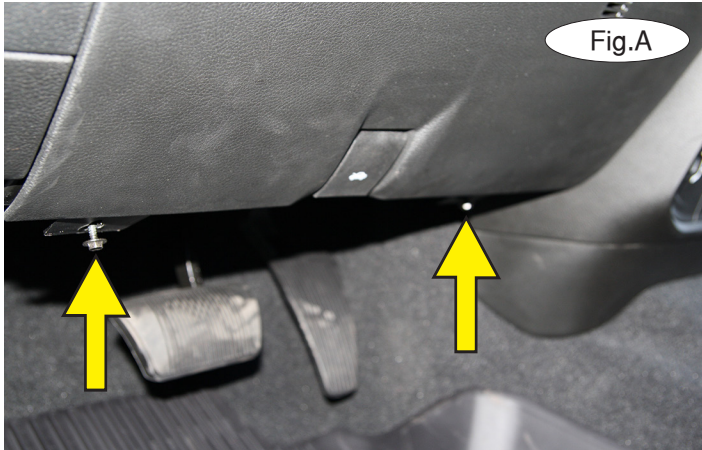

1. Remove two 7mm screws attaching the center underdash panel to the dash (Fig.A). Pull out to release the underdash panel (Fig.B). Disconnect any wiring harnesses and the hood release cable and set the panel aside for now.
2. Remove the computer box, if the vehicle is so equipped. Slide it up to release it from its mounts, and then let it hang down for now (Fig.C).

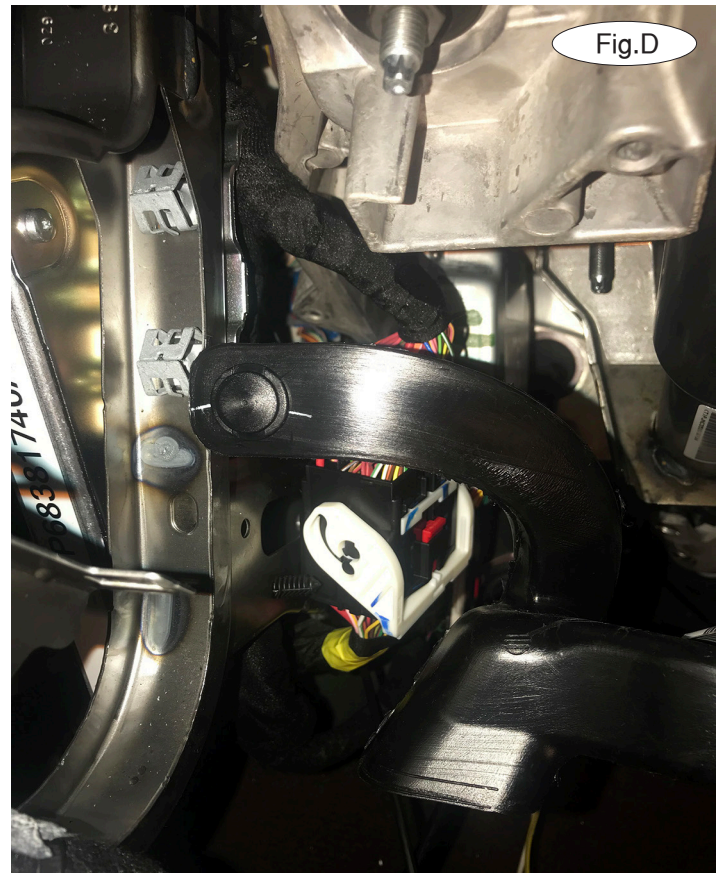
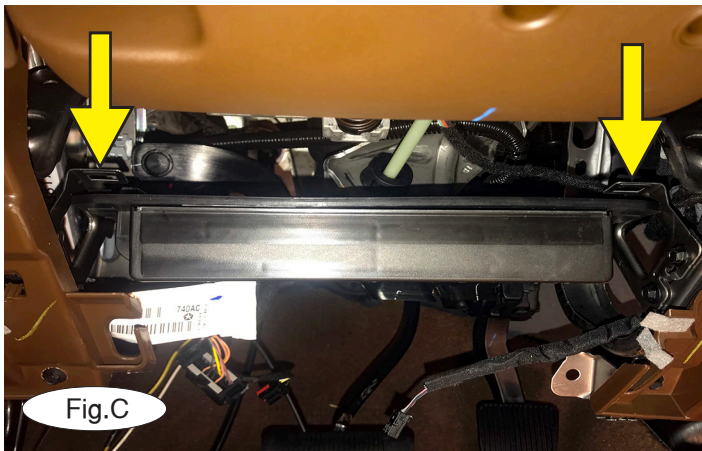

3. On the left hand side of the steering column, remove one plastic fastener attaching the floor vent to the underdash. Pull toward the outside of the vehicle to remove it temporarily (Fig.D).

*continued on next page*



**WARNING**

Failure to follow these instructions can result in property damage, personal injury or even death.

1-800-669-9690

# BRAKE LIGHT SWITCH BRACKET AND WIRING KIT INSTALLATION INSTRUCTIONS #751500



#6057-00 08-19

ALL SPECIFICATIONS ARE SUBJECT TO CHANGE WITHOUT NOTICE

ROADMASTER, Inc. 6110 NE 127th Ave. Vancouver, WA 98682 360-896-0407 fax 360-735-9300 www.roadmasterinc.com



Fig.E

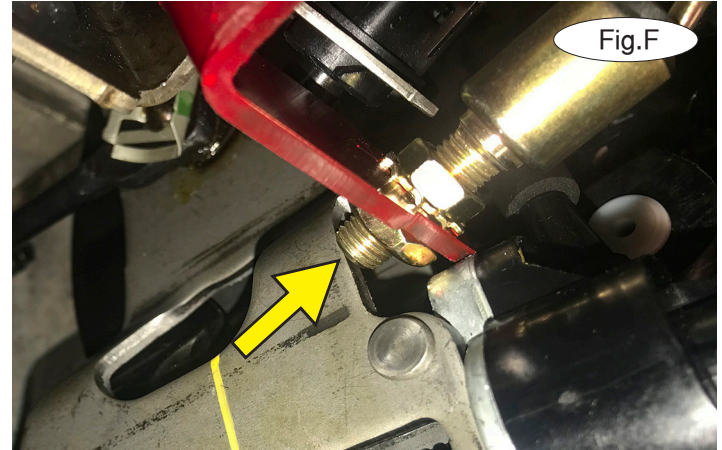

Fig.F

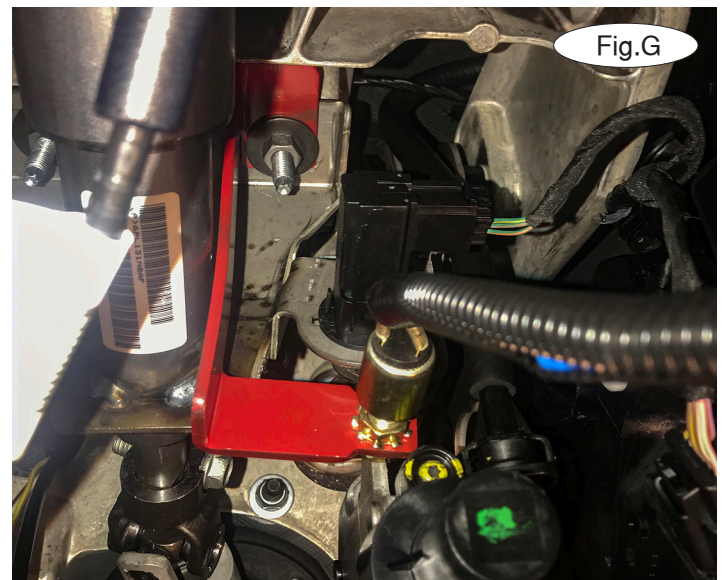

Fig.G

4. Above the brake light switch, remove a 13mm (head) nut attaching the rear of the steering column to the underdash. Place the brake light switch bracket over the stud and replace the nut (Fig.E).
5. Now, depress the brake pedal while you install the switch into the bracket. Adjust the brake light switch as necessary to allow for proper activation of the plunger on the switch (Fig.F). *Note:* Due to manufacturing variances, some additional adjustments to the bracket may be required to ensure that the plunger is centered over the narrow brake pedal arm (Fig.G).

## WARNING

When the installation is complete, verify that the brake pedal retracts fully.

Unless they are installed correctly, the bracket and/or other kit components may restrict or impede the movement of the brake pedal – the brake pedal will not retract fully.

If the brake pedal does not retract fully, the brakes will be applied continuously, which may cause severe tire and/or brake system damage, as well as other consequential, non-warranty damage.

Failure to follow these instructions may cause property damage, personal injury or even death.



## WARNING

Failure to follow these instructions can result in property damage, personal injury or even death.



Time Tested • Time Proven

855338-02 06.16

ROADMASTER, Inc. • 6110 N.E. 127th Ave. • Vancouver, WA 98682 • 800-669-9690 • Fax 360-735-9300 • roadmasterinc.com

# metal Brake Light Switch

part number 300188-00

## Installation Instructions

All specifications are subject to change without notice.

### Purpose of this kit

This kit is necessary if...

...you are installing a supplemental braking system with a monitor and the brake lights do not function when the vehicle is in the "tow" mode.

...you are installing a supplemental braking system and the vehicle is equipped with a "retained accessory power" feature. (With this feature, the vehicle's electronics continue to function normally for about ten minutes after the ignition is turned off. Then the electronics will no longer function, which shuts off power to the OEM brake light switch.)

### Step A – Install the brake light switch

1. Thread the first adjusting nut (Figure A) onto the brake light switch.
2. Slide the threaded side of the brake light switch through the brake light switch mounting bracket.
3. Position the star washer against the bracket.
4. Thread the second adjusting nut onto the brake light switch. (Do not fully tighten the nut at this time.)
5. With the brake light switch in position, attach the mounting bracket – refer to the vehicle-specific instructions that are attached to these instructions.
6. Preliminary adjustment to the brake light switch – make certain that the brake pedal is not depressed. Then turn the adjusting nuts until the white plunger at the end of the brake light switch is completely depressed, as shown in Figure A.

### CAUTION

The brake light switch must be installed as directed above. If it is not, it may cause a dashboard error message.

Additionally...

- The plunger must be completely depressed against the brake arm. Otherwise, it may cause a false brake light signal at the monitor.
- The brake pedal must not be depressed when the brake light switch is installed. If it is, the brake pedal may depress the towed vehicle's brakes continuously, which will cause excessive brake wear, brake system damage or other consequential, non-warranty damage.

### Step B – Select a power source

Power for the switch can come from either the battery or the fuse block. The fuse block is typically an easier connection.

#### Option 1 – Power from the fuse block

Identify a fuse that is constantly powered when the

ignition is in the "tow" position. Pull the fuse.

*Note: make certain this fuse is not part of a "retained accessory power" circuit – see "Purpose of this kit," above.*

Insert the fuse you just pulled into the slot closest to the fuse blades (Figure B), then insert the fuse tap into the empty slot in the fuse box (Figure C).

Proceed to Step C.

continued on next page

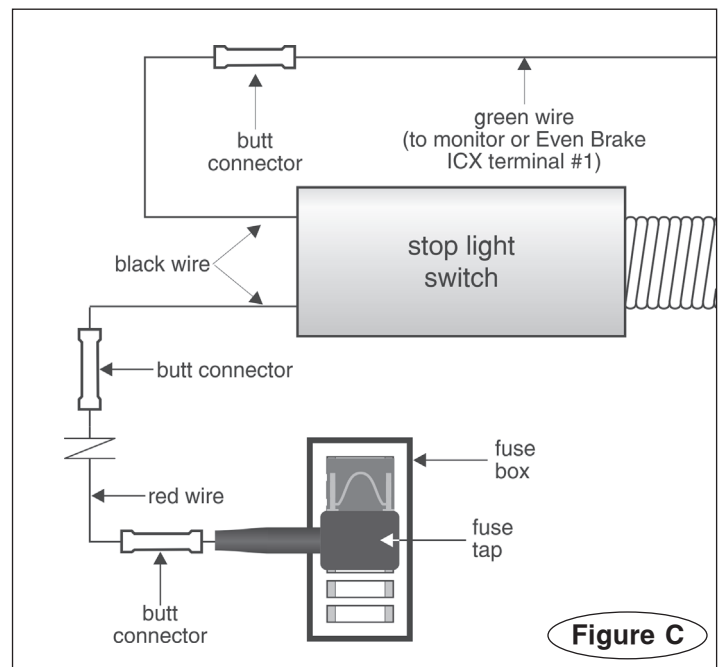
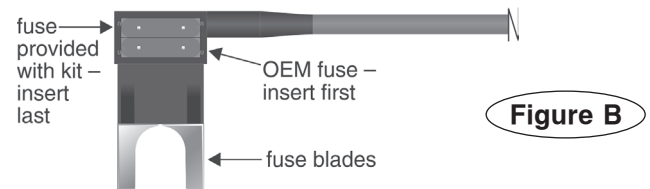
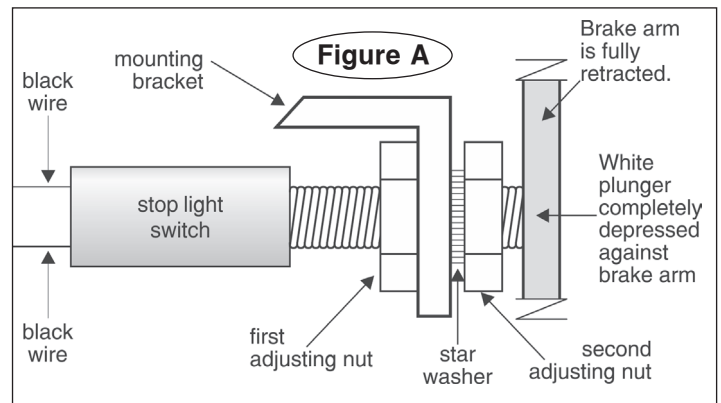

continued from preceding page

### Option 2 – Power from the battery

Use the provided ring terminal to connect a fuse holder to the positive terminal on the vehicle's battery (Figure D).

*Note: if a fuse holder is included in this kit, the manufacturer has recommended disconnecting the battery of one or more makes of this vehicle to tow.*

*Note: if the vehicle's battery must be disconnected for towing and a Roadmaster battery disconnect device has been installed, make certain that the ring terminal is connected to the positive side of the battery disconnect device. If it is, then 12VDC+ will be present when the battery is disconnected.*

Proceed to Step C.

### Step C – Connect to power

1. Use the provided red wire and butt connectors to connect the fuse holder or fuse tap (depending on which power source you chose) to either one of the black wires extending from the brake light switch (Figure C or D).

2. Insert the provided 10-amp fuse into the fuse tap or fuse holder.

### Step D – Final adjustment to the brake light switch

1. Attach a circuit tester or volt meter to the other black wire extending from the brake light switch.

2. Rotate the switch in or out until it takes approximately 1/8" of brake pedal travel to register 12VDC+ on your tester.

3. With the vehicle's engine on, verify that the brake lights illuminate properly when the brake pedal is depressed.

*Note: if, after installation, the supplemental brake monitor light flickers on and off while towing, readjust the switch.*

*Note: if the monitor light does not function, check the brake light switch first.*

4. Once adjusted, tighten both nuts.

### Step E – Wire the switch to the motorhome monitor

1. For Even Brake **only** – connect the green wire to the terminal marked "1" on the Even Brake ICX transmitter (Figure D).

2. For all ROADMASTER braking systems **except** Even Brake – using a butt connector, connect the remaining switch wire to the motorhome monitor wire. Use the green wire if you need to extend the wire length.

### Step F – Test for clearance

With the engine on, depress the brake pedal to its farthest extent, then allow it to fully return. Make certain that the brake light switch bracket or other kit components do not impede the full and complete movement of the brake pedal.

### WARNING

**When the installation is complete, verify that the brake pedal retracts fully.**

**Unless they are installed correctly, the bracket wiring and/or other kit components may impede the movement of the brake pedal.**

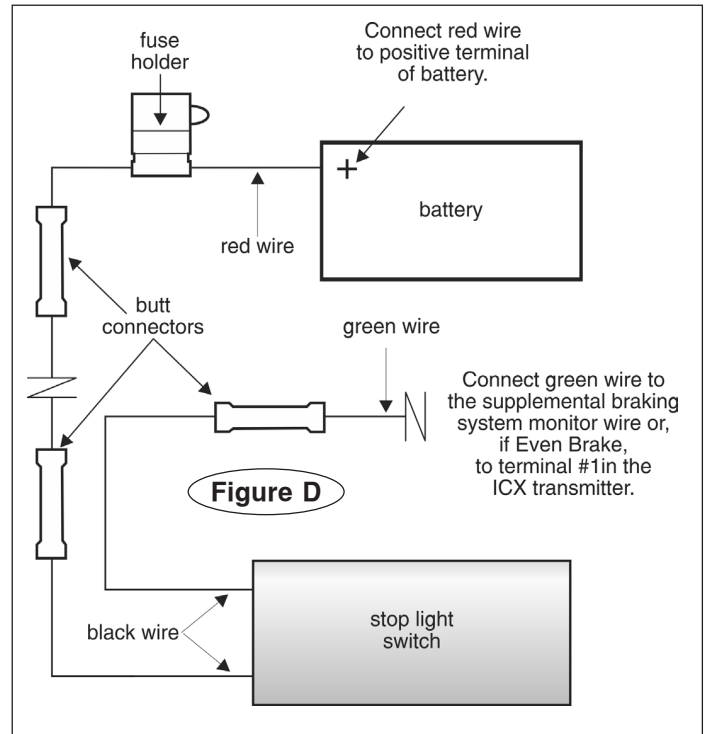

**If the brake pedal does not retract fully, the brakes will be applied continuously, which may cause severe tire and/or brake system damage, as well as other consequential, non-warranty damage.**

**Failure to follow these instructions may cause property damage, personal injury or even death.**