



BASEPLATE KIT INSTALLATION INSTRUCTIONS

KIT# 920-3
04/1/19
KS

ROADMASTER, Inc. 6110 NE 127th Ave. Vancouver, WA 98682 360-896-0407 fax 360-735-9300 www.roadmasterinc.com

Important
Note: this bracket will not accommodate the Guardian rock shield, some models of the Tow Defender, Stowaway or the StowMaster and StowMaster All Terrain tow bars.

fits Legacy Outback, Outback and Legacy sedan

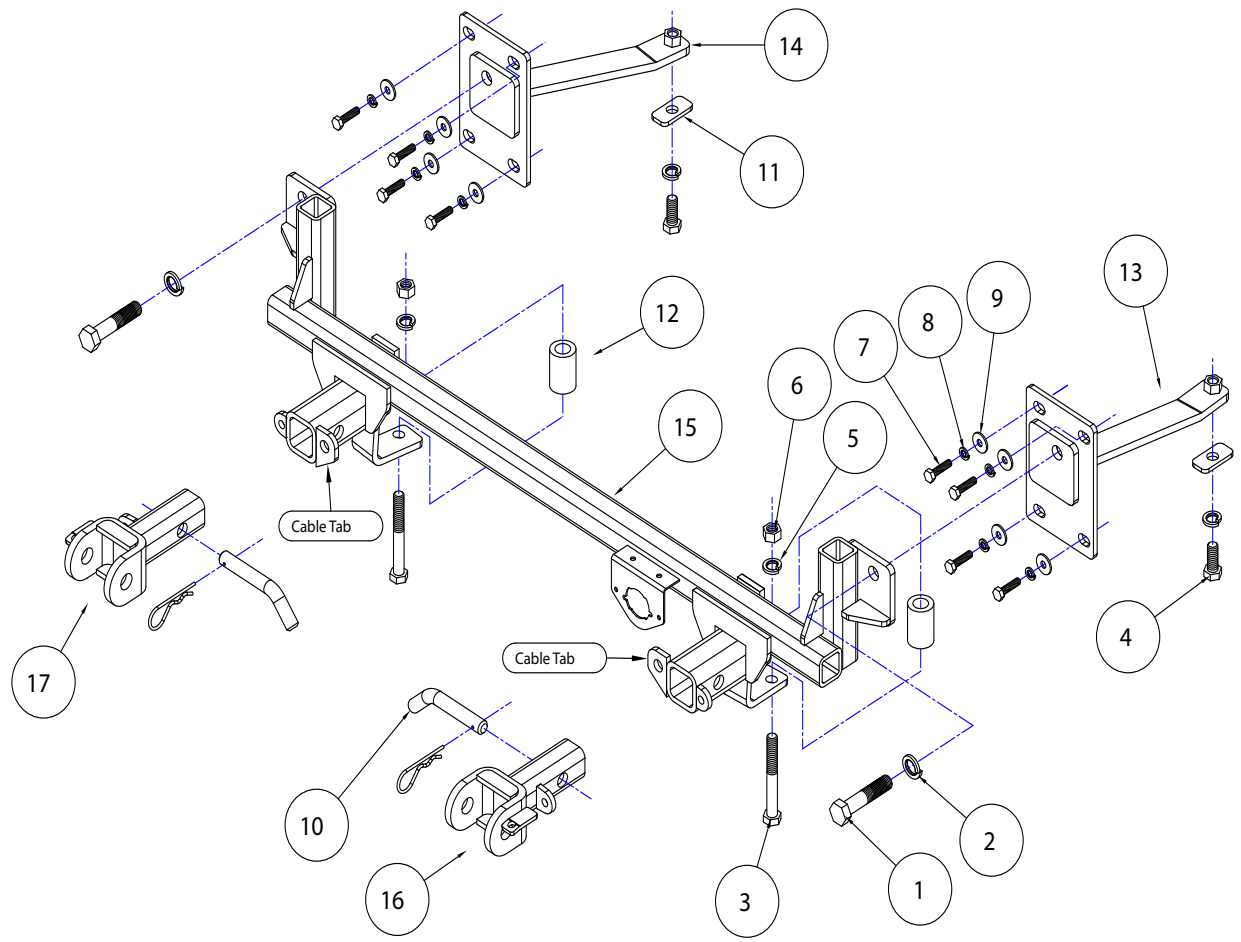

ITEM	QTY	NAME	MATERIAL
1	2	5/8" x 2" BOLT	350150-00
2	2	5/8" LOCK WASHER	350313-00
3	2	1/2" x 4" BOLTS	350105-00
4	2	1/2" x 1 1/2" BOLT	350095-00
5	4	1/2" LOCK WASHER	350309-00
6	2	1/2" HEX NUT	350258-00
7	8	M8 x 1.25 x 30 mm BOLT	356001-00
8	8	M8 LOCK WASHER	355705-00
9	8	M8 FENDER WASHER	355702-00
10	2	5/8" DRAW PIN W/ CLIP	357035-00
11	2	3/16" x 1" x 2" BACKING PLATE	A-000842
12	2	1 1/4" O.D. x 0.25 WALL x 1 7/8" PIPE SPACER	A-001011
13	1	DRIVER SIDE BRACE	C-001602
14	1	PASSENGER SIDE BRACE	C-001603
15	1	MAIN RECIVER	C-001899
16	1	DRIVER SIDE ARM	C-001477
17	1	PASSENGER SIDE ARM	C-001476
18	2	#10 x 1/2" SELF TAPPING SCREW	350247-30
19	1	ZIP TIE	300140-8



BASEPLATE KIT INSTALLATION INSTRUCTIONS

KIT# 920-3

04/1/19
KS

ROADMASTER, Inc. 6110 NE 127th Ave. Vancouver, WA 98682 360-896-0407 fax 360-735-9300 www.roadmasterinc.com

This bracket kit is one of our MX series, which allows the visible front portion of the brackets to be easily removed (Fig.A and Fig.B). The kit consists of the main receiver brace, rear support braces, removable front braces and a hardware pack.

The main receiver brace mounts to the frame rails and bumper core mounting points on each side. The removable front braces insert into the receivers on each side and are secured with draw pins. Before starting the installation, lay out the kit components in order, as they will be used. This will give you a visual idea of how the components work, and will also confirm that everything is present and accounted for.



Fig.A



Fig.B

IMPORTANT: All baseplates **must** be assembled with all the bolts left loose for final adjustment and positioning (before tightening) unless otherwise instructed. All bolts **must** be torqued for proper strength. If more than one bolt is used per fastening point, the diagram may only show one. Use flat washers over all slotted holes and lock washers on all fasteners.

WARNING

Failure to heed these warnings or follow the installation instructions may result in a voided warranty, loss of towed vehicle, personal injury or death.

- Do not weld or modify this baseplate or its components. Welding or modification will void the warranty.
- Do not use this document as a basis to design/fabricate a baseplate, as it may not show all parts or structural components.
- We strongly recommend professional installation.
- If the towed vehicle has been in an accident, it must be properly repaired before attaching the baseplate. Do not install the baseplate if any structural frame damage is found.
- The installer must use all bolts and parts supplied. If running changes were made by the vehicle manufacturer after this kit was designed, some bolts or other fasteners may no longer be the correct size. It is the installer's responsibility to verify this kit is securely fastened to the vehicle.
- Use Loctite® Red on all bolts used to secure this baseplate. Torque all bolts to the specifications found at the end of these instructions. Do not over-torque the bolts or failure may occur.
- The installer must inspect the baseplate to ensure adequate clearance, particularly around hoses, air conditioner lines, radiators, etc. or non-warranty failure may result.
- Roadmaster manufactures many styles of baseplates. If your baseplate has removable arms, they must be removed before driving the vehicle, unless the arms can be pinned or padlocked in place. If not secured, the arms could vibrate out.
- Some motorhome chassis have such a tight turning radius that you can damage your motorhome, towed vehicle, tow bar or baseplate while turning sharply. Before getting on the road, test your turning radius in an empty parking lot. Turning too sharply could result in non-warranty damage to your towing system, motorhome and/or towed vehicle.
- Do not back up with the towed vehicle attached or non-warranty damage will occur to your towing system or vehicles.
- The safety cables must connect the towing vehicle to the towed vehicle frame to frame, with the cables crossed, with enough slack for sharp turns. See cable instructions for proper routing. Failure to do so will result in non-warranty damage and/or the loss of the towed vehicle.
- This kit is designed for use with ROADMASTER tow bars and ROADMASTER adapters only. Using this kit with other brands, without an approved ROADMASTER adapter, may result in non-warranty damage or injury.
- Receiver extensions and out-of-level towing situations of 3 inches or more. This can cause the system to swing much higher and lower, causing excessive strain on the tow bar, baseplate and frame. That can cause the towing system to fail, causing property damage, personal injury or even death. If you must use a receiver extension or drop hitch to tow, it will reduce your receiver's weight capacity by 1/3 to avoid damaging your system. Never use more than one extension and/or drop hitch, as this will void your warranty.
- Every 3,000 miles, the owner must inspect all mounting points for cracks or fatigue, and check the fasteners for proper torque, according to the bolt torque requirements chart on the last page of these instructions.
- The owner must follow the vehicle manufacturer's instructions to prepare the vehicle for towing. Failure to do so may cause severe damage to the vehicle.
- This baseplate is only warranted for the original installation. Installing a used baseplate on another vehicle is not recommended and will void the warranty.



BASEPLATE KIT INSTALLATION INSTRUCTIONS

KIT# 920-3

04/1/19
KS

ROADMASTER, Inc. 6110 NE 127th Ave. Vancouver, WA 98682 360-896-0407 fax 360-735-9300 www.roadmasterinc.com



1. **Important:** please use all supplied bolts and parts and read all instructions carefully before beginning this installation. The majority of questions you may have can be answered within the text, and proper installation will ensure safe and secure travel. Now, begin the installation by removing six plastic fasteners attaching the top of the fascia to the core support (Fig.C).

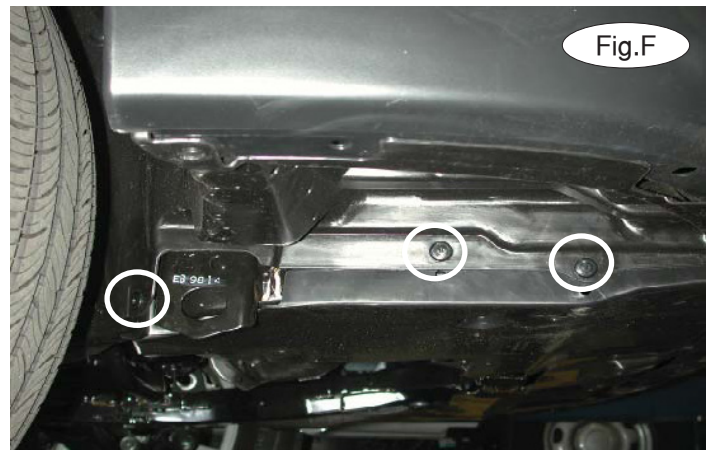

2. On each side, remove one plastic fastener attaching the corner of the fascia to the splash shield (Fig.D).
3. Remove nine plastic fasteners located along the bottom of the fascia to the splash shield (Fig.E – driver's side). *Note:* only three of the fasteners are shown in Figure E.
4. Remove three plastic fasteners attaching the center splash shield to the fender liner on each side (Fig. F – passenger side).
5. On each side, remove two plastic fasteners and one 12mm (head) screw attaching the center splash shield to the subframe (Fig.G).
6. Disconnect the fog lights, if the vehicle is so equipped.





BASEPLATE KIT INSTALLATION INSTRUCTIONS

KIT# 920-3

04/1/19
KS

ROADMASTER, Inc. 6110 NE 127th Ave. Vancouver, WA 98682 360-896-0407 fax 360-735-9300 www.roadmasterinc.com

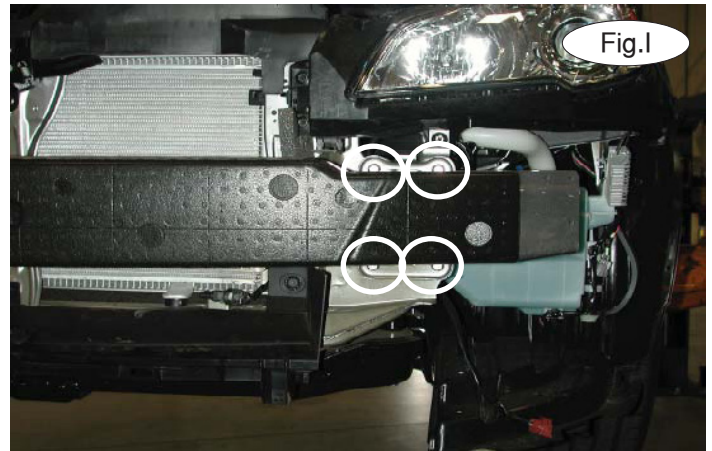

7. Pull out and forward on the fascia to remove it (Fig.H).

8. Remove the eight 12mm (head) bolts attaching the bumper core to the end of the frame rails (Fig.I). The main receiver brace will be replacing the bumper core. *Note:* retain the bumper core and attachment hardware so that it can be replaced if the bracket is ever removed.

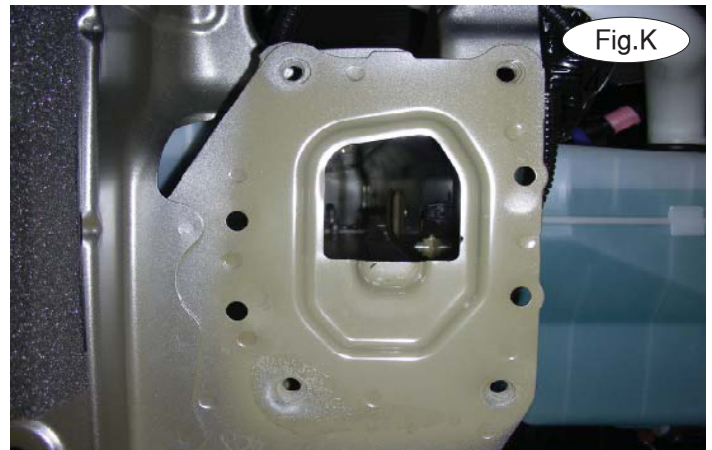

9. Remove six plastic fasteners attaching the center air deflector to the radiator support. *Note:* there are three located on the top (Fig.J) and three on the bottom.

10. On each side, use a die grinder to enlarge the top of the frame rail opening so it is even with the top of the inside of the frame rail. Figure K shows the frame rail opening before the grinding and Figure L shows after the trimming.





BASEPLATE KIT INSTALLATION INSTRUCTIONS

KIT# 920-3

04/1/19
KS

ROADMASTER, Inc. 6110 NE 127th Ave. Vancouver, WA 98682 360-896-0407 fax 360-735-9300 www.roadmasterinc.com

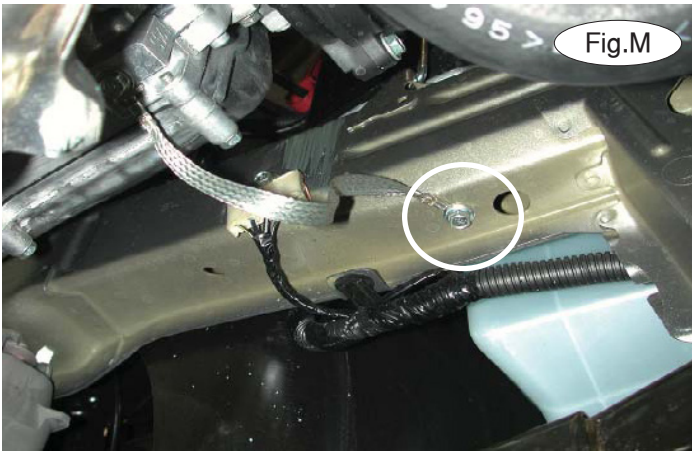

11. On each side, remove a 10mm (head) bolt attaching the engine ground straps to the bottom of the frame rail (Fig.M).
12. On each side, using the provided $\frac{3}{4}$ " self-tapping screw, relocate the ground straps approximately $\frac{3}{4}$ " further back on the bottom of the frame rail (Fig.N).



13. Place the driver and passenger side rear support braces through the ends of the frame rails (Fig.O).
14. Place a $\frac{1}{2}$ " lock washer over a $\frac{3}{16}$ " x 1" x 2" backing plate over a $\frac{1}{2}$ " x $1\frac{1}{2}$ " bolt and place it through the bottom of the frame rail and into the rear support mounting point (Fig.P).
15. Using eight 8mm x 1.25 x 30mm bolts, 8mm lock washers and 8mm fender washers, bolt the two rear supports to the ends of the frame rails (Fig.Q).

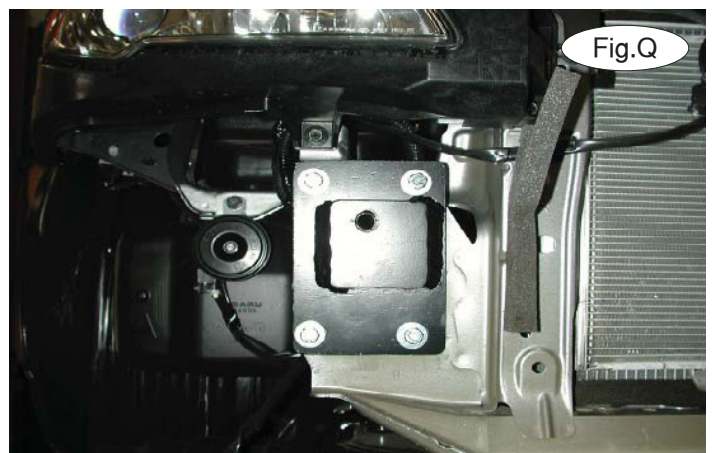



BASEPLATE KIT INSTALLATION INSTRUCTIONS

KIT# 920-3

04/1/19
KS

ROADMASTER, Inc. 6110 NE 127th Ave. Vancouver, WA 98682 360-896-0407 fax 360-735-9300 www.roadmasterinc.com

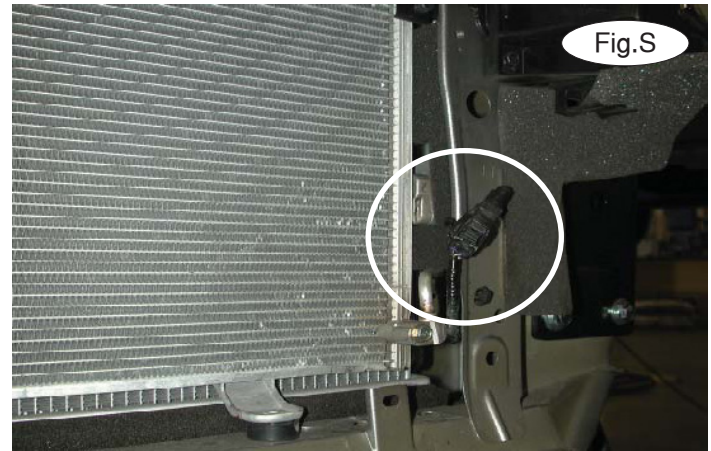
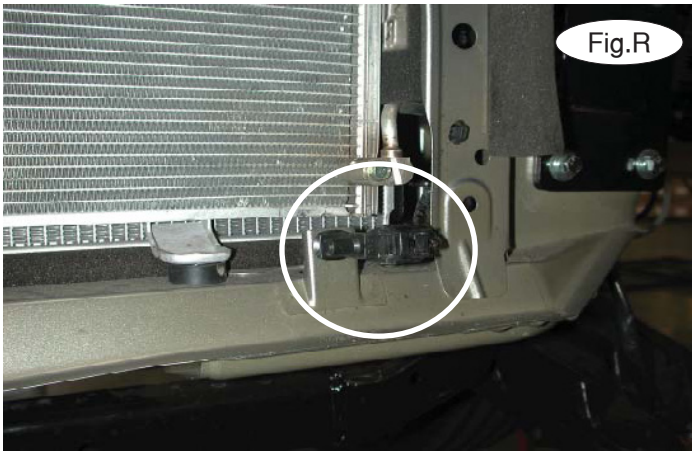

16. Remove one plastic fastener attaching the ambient temperature sensor to the core support (Fig.R) and zip tie it to the side of the radiator support (Fig.S).

17. Using the two supplied 5/8" x 2" bolts and lock washers, bolt the main receiver brace to the rear support braces (Fig.T).

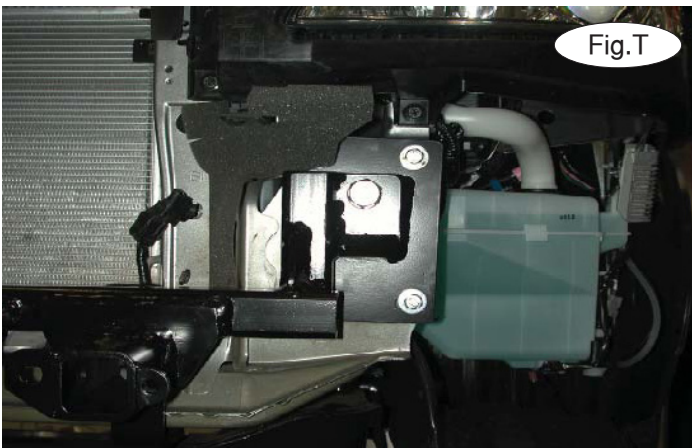

18. Using the bolt torque specifications found at the end of these instructions, torque the 8mm bolts first, then the 1/2" bolts and finally, the 5/8" bolts.

19. Using a 1/2" drill and the lower hole in the main frame as a template, enlarge the existing upper and lower holes in the brace (Fig.U).

20. On each side, push up on the rubber mount for the air conditioner condenser and insert a 1 1/4" x 1-7/8" pipe spacer inside the radiator support (Fig.V).





BASEPLATE KIT INSTALLATION INSTRUCTIONS

KIT# 920-3

04/1/19
KS

ROADMASTER, Inc. 6110 NE 127th Ave. Vancouver, WA 98682 360-896-0407 fax 360-735-9300 www.roadmasterinc.com

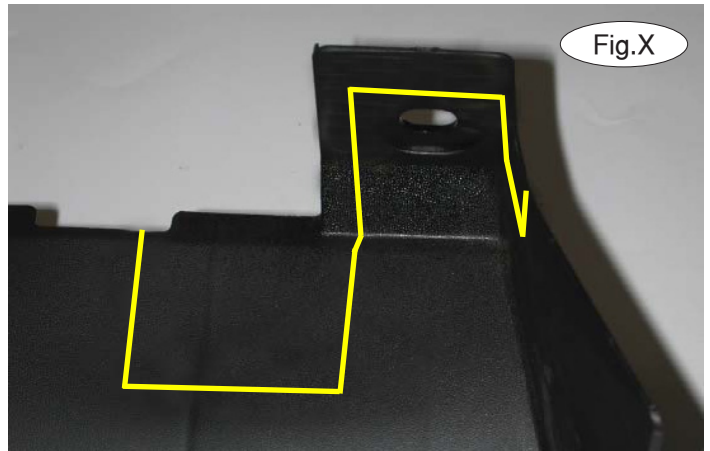
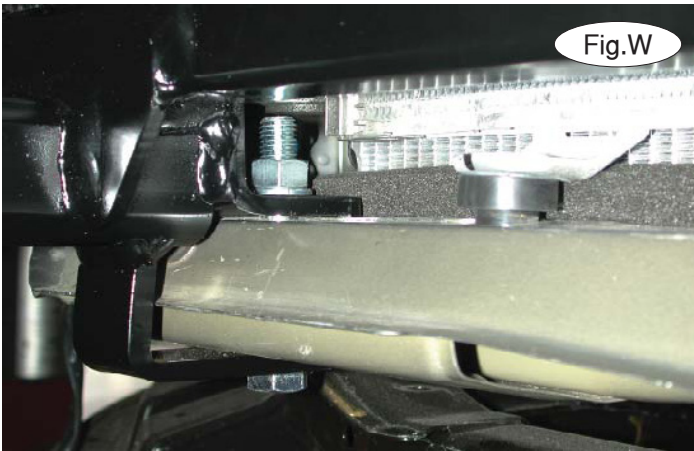

21. Align the pipe spacer with the lower mount and bolt through the lower mount, spacer, and radiator support using a 1/2" x 4" bolt, lock washer and nut (Fig.W). Torque the bolts to the bolt torque specifications found at the end of these instructions.

22. Trim or leave off the center air deflector. If you trim it, use the yellow lines in Figure X (driver's side) as a guide for trimming. Reinstall the center air deflector (Fig.Y). *Note:* only the bottom and top center fasteners can be replaced.

23. Reinstall the fascia, reversing steps 1 through 7.

24. Insert the removable front bracket arms into the front receiver braces, and secure them in place with the supplied 5/8" draw pins and spring pins.

25. Connect the safety cables to the safety cable tabs illustrated on the first page of these instructions.



BOLT TORQUE REQUIREMENTS

Note: The torque values represented below are intended as general guidelines. Torque requirements for specific applications may vary. Roadmaster does not warrant this information to be accurate for all applications and disclaims all liability for any claims or damages which may result from its use.

STANDARD BOLTS

Thread Size	Grade	Torque
5/16.....	5.....	13 ft./lb.
3/8.....	5.....	23 ft./lb.
7/16.....	5.....	37 ft./lb.
1/2.....	5.....	56 ft./lb.
5/8.....	5.....	150 ft./lb.

METRIC BOLTS

Thread Size	Grade	Plated / Unplated
8mm-1.0.....	8.8.....	20 ft./lb. 18 ft./lb.
8mm-1.25.....	8.8.....	19 ft./lb. 18 ft./lb.
10mm-1.25.....	8.8.....	38 ft./lb. 36 ft./lb.
10mm-1.5.....	8.8.....	37 ft./lb. 35 ft./lb.

METRIC BOLTS

Thread Size	Grade	Plated / Unplated
12mm-1.25.....	8.8.....	70 ft./lb. 65 ft./lb.
12mm-1.5.....	8.8.....	66 ft./lb. 61 ft./lb.
12mm-1.75.....	8.8.....	65 ft./lb. 60 ft./lb.
14mm-2.0.....	8.8.....	104 ft./lb. 97 ft./lb.

All illustrations and specifications contained herein are based on the latest information available at the time of publication approval. ROADMASTER, INC. reserves the right to make changes at any time without notice in material, specification and models or to discontinue models.